

PACCAR TRANSMISSIONS

TX-18

18 Speed
Transmission

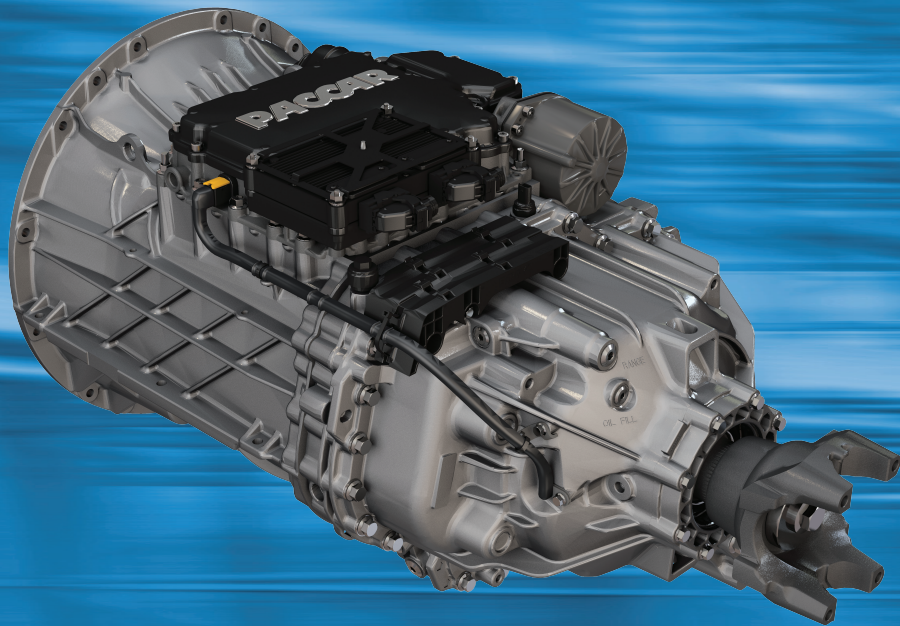

Operator's Manual

Safety	1
Features	2
Indications	3
Controls	4
Operation	5
Maintenance	6
Specifications	7

© 2022 PACCAR Inc. - All Rights Reserved

This manual illustrates and describes the operation of features or equipment which may be either standard or optional on this vehicle. This manual may also include a description of features and equipment which are no longer available or were not ordered on this vehicle. Please disregard any illustrations or descriptions relating to features or equipment which are not on this vehicle. PACCAR reserves the right to discontinue, change specifications, or change the design of its vehicles at any time without notice and without incurring any obligation. The information contained in this manual is proprietary to PACCAR. Reproduction, in whole or in part, by any means is strictly prohibited without prior written authorization from PACCAR Inc.

Chapter 1 | SAFETY

Using this Manual.....	5
Safety Alerts.....	5
Illustrations.....	6
General Safety Instructions.....	6
Repairs.....	9

Using this Manual

Please take the time to get acquainted with your vehicle by reading this Operator's Manual. We recommend that you read and understand this manual from beginning to end before you operate this equipment. This manual contains useful information for the safe and efficient operation of this equipment. It also provides service information, with an outline for performing safety checks and basic preventive maintenance inspections. When replacement parts are needed, we recommend using only genuine PACCAR parts.

We have tried to present the information needed to learn about functions, controls, and operation—and to present it as clearly as possible. Occasionally, you may need to reference this manual, and we hope you find it easy to use.

	NOTE
After you've read this manual, it should be stored in the cab for convenient ref-	

erence and remain with this truck when sold.
--

Your vehicle may not have all the features or options mentioned in this manual. Therefore, you should pay careful attention to the instructions that pertain to just your vehicle. In addition, if your vehicle is equipped with special equipment or options not discussed in this manual, consult your dealer or the manufacturer of the equipment.

There are several tools built into this manual to help you find what you need quickly and easily; first is the Table of Contents. Located at the front of the manual, this table arranges the subject matter into chapters, which can be quickly referenced using the numbers shown in the outer margin. The first page of each chapter presents a list of the major subjects contained in that chapter. Cross-referenced citations can also help you find information. If more information on the current subject is located elsewhere in the manual, a cross-reference may be provided, such as "see [Safety Alerts](#) on page 5." Finally, you'll find a helpful index at the back of the manual, which lists the subjects covered, alphabetically.

All information contained in this manual is based on the latest production information available at the time of publication. If you find differences between your instruments and the information in this manual, contact an authorized PACCAR dealer. PACCAR reserves the right to make changes at any time without notice.

Safety Alerts

Read and follow all of the safety alerts contained in this manual. They are there for your protection and information. These alerts can help you avoid injury to yourself, your passengers, and help prevent costly damage to the vehicle. Safety alerts are highlighted by safety alert symbols and signal words such as WARNING, CAUTION, or NOTE. **Do not** ignore any of these alerts.

Warnings



The safety message following this symbol and signal word provides a warning against operating procedures that could cause death or injury. They could also cause

equipment or property damage. The alert will identify the hazard, how to avoid it, and the probable consequence of not avoiding the hazard.

Example:



WARNING

Hot engine oil can be dangerous. You could be burned. Let the engine oil cool down before changing it. Failure to comply may result in death, personal injury, equipment or property damage.

Cautions



The safety message following this symbol and signal word provides a caution against operating procedures that could cause equipment or property damage. The alert will identify the hazard, how to avoid it, and the probable consequence of not avoiding the hazard.

Example:



CAUTION

Continuing to operate your vehicle with insufficient oil pressure will cause serious engine damage. Failure to comply may result in equipment or property damage.

Notes



The message following this symbol and signal word provides important information that is not safety related but should be followed. The alert will highlight things that may not be obvious and is useful to your efficient operation of the vehicle.

Example:



NOTE

Pumping the accelerator pedal will not assist in starting the engine.

Illustrations

Some of the illustrations found in this manual are generic, and may not look exactly like the parts or assemblies you find installed on your vehicle.

When an illustration differs from what you see physically present on your vehicle, the language describing the procedure will still be correct for your application.

General Safety Instructions



WARNING

Improper practices, carelessness, or ignoring any warnings may cause property damage, personal injury, or death.

Before performing any repair, read and understand all of the safety precautions and warnings. The following is a list of general safety precautions that must be followed to provide personal safety. Failure to follow these instructions may cause death or injury. Special safety precautions

are included in the procedures when they apply. Keep in mind that even a well maintained vehicle must be operated within the range of its mechanical capabilities and the limits of its load ratings. See the Weight Ratings label on the driver's door edge. Every new vehicle is designed to conform to all Federal Motor Vehicle Safety Standards applicable at the time of manufacture. Even with these safety features, continued safe and reliable operation depends greatly upon regular vehicle maintenance. Follow the maintenance recommendations found in the Preventive Maintenance section. This will help preserve your investment. Make sure your vehicle is in top working condition before heading out on the road, it is the responsible driver's duty to do so. Inspect the vehicle according to the Driver's Check List.

- Work areas should be dry, well lit, well ventilated, free from clutter, loose tools, parts, ignition sources and hazardous substances.
- Wear protective glasses and protective shoes when working.
- Wear protective gloves when working with hot liquids or surfaces.

- DO NOT wear loose-fitting or torn clothing. Tie back and/or tuck in long hair. Remove all jewelry when working.
- Before beginning any repair, disconnect the battery (negative [-] cable) and discharge any capacitors.
- Put a "DO NOT OPERATE" tag in the operator's compartment or on the controls.
- Allow the engine to cool before slowly loosening the coolant fill cap to relieve the pressure from the cooling system.

 **WARNING**

Removing the fill cap on a hot engine can cause scalding coolant to spray out and burn you badly. If the engine has been in operation within the previous 30 minutes, be very careful in removing the fill cap. Protect face, hands, and arms against escaping fluid and steam by covering the cap with a large, thick rag. DO NOT try to remove it until the surge tank cools down or if you see any steam or coolant es-

caping. Always remove the cap very slowly and carefully. Be ready to back off if any steam or coolant begins to escape. Failure to comply may result in death, personal injury, equipment or property damage.

- Always use wheel chocks or proper jack stands to support the vehicle or vehicle components before performing any service work. DO NOT work on anything that is supported only by lifting jacks or a hoist. Before resting a vehicle on jack stands, be sure the stands are rated for the load you will be placing on them.
- Before removing or disconnecting any lines, fittings, or related items, relieve all pressure in the air, oil, fuel, and cooling systems. Remain alert for possible pressure when disconnecting any device from a system that contains pressure. High-pressure oil or fuel can cause death or personal injury.
- Always wear protective clothing when working on any refrigerant lines and make sure that the workplace is well ventilated.

Inhalation of fumes can cause death or personal injury. To protect the environment, liquid refrigerant systems must be properly emptied and filled using equipment that prevents the release of refrigerant gas. Federal law requires capturing and recycling refrigerant.

- When moving or lifting any heavy equipment or parts, make sure to use proper techniques and assistance. Ensure all lifting devices such as chains, hooks, or slings are in good condition and are of the correct load capacity. Make sure all lifting devices are positioned correctly.
- Corrosion inhibitors and lubricating oils may contain alkali. DO NOT get the substance in eyes and avoid prolonged or repeated contact with skin. DO NOT swallow. If ingested, seek immediate medical attention. DO NOT induce vomiting. In case of contact, immediately wash skin with soap and water. In case of harmful contact, immediately contact a physician. Always keep any chemicals OUT OF REACH OF CHILDREN.
- Naphtha and Methyl Ethyl Ketone (MEK) are flammable materials and must be used with caution. Follow the manufacturer's instructions to ensure safety when using these materials. Always keep any chemicals OUT OF REACH OF CHILDREN.
- When working on the vehicle, be alert for hot parts on systems that have just been turned off, exhaust gas flow, and hot fluids in lines, tubes, and compartments. Contact with any hot surface may cause burns.
- Always use tools that are in good condition. Make sure you have the proper understanding of how to use the tools before performing any service work. Use only genuine replacement parts from PACCAR.
- Always use the same fastener part number (or equivalent) when replacing items. DO NOT use a fastener of lesser quality if replacements are necessary. (e.g., DO NOT replace an SAE 10.9 grade with 8.8 grade fastener.)
- Always torque fasteners and fuel connections to the required specifications. Overtightening or under-tightening can allow leakage.
- Close the manual fuel valves prior to performing maintenance and repairs, and when storing the vehicle inside.
- DO NOT perform any repair when impaired, tired, fatigued, or after consuming alcohol or drugs that can impair your functioning.
- Some state and federal agencies in the United States of America have determined that used engine oil can be carcinogenic and can cause reproductive toxicity. Avoid inhalation of vapors, ingestion, and prolonged contact with used engine oil.
- DO NOT connect the jump starting or battery charging cables to any ignition or governor control wiring. This can cause electrical damage to the ignition or governor.
- Coolant is toxic. If not reused, dispose of coolant in accordance with local environmental regulations.

**CAUTION**

Corrosive chemicals can damage the engine. DO NOT use corrosive chemicals on the engine. Failure to comply may result in equipment or property damage.

California Proposition 65 Warning

- Diesel engine exhaust and some of its constituents are known to the State of California to cause cancer, birth defects, and other reproductive harm.
- The catalyst substrate located in the Diesel Particulate Filter (DPF) contains vanadium pentoxide, which has been determined by the State of California to cause cancer. Always wear protective clothing and eye protection when handling the catalyst assembly. Dispose of the catalyst in accordance with local regulations. If catalyst material gets into the eyes, immediately flood eyes with water for a minimum of 15 minutes. Avoid prolonged contact with skin. In case of contact, immediately wash

skin with soap and water. In case of harmful contact, immediately contact a physician.

- Other chemicals in this vehicle are also known to the State of California to cause cancer, birth defects or other reproductive harm.
- Battery posts, terminals, and related accessories contain lead and lead compounds, chemicals known to the State of California to cause cancer and reproductive harm. Wash hands after handling.

Repairs**WARNING**

DO NOT attempt repair work without sufficient training, service manuals, and the proper tools. You could be killed or injured, or you could make your vehicle unsafe. Perform only those tasks you are fully qualified to do.

**WARNING**

Modifying your vehicle can make it unsafe. Some modifications can affect your vehicle's electrical system, stability, or other important functions. Before modifying your vehicle, check with your dealer to make sure it can be done safely. Improper modifications can cause death or personal injury.

**CAUTION**

The installation of electronic devices to the On-board Diagnostics (OBD) connector, the vehicle Controller Area Network (CAN), or their associated wiring is not permitted. Doing so can adversely affect vehicle performance and/or cause fault codes to be recorded. The OBD connector is provided for temporary connection of service tools and for diagnostic purposes only.

Your dealer's service center is the best place to have your vehicle repaired. You can find dealers all over the country with the equipment and trained personnel to get

you back on the road quickly—and keep you there.

Your vehicle is a complex machine. Anyone attempting repairs on it needs good mechanical training and the proper tools. However, all warranty repairs must be performed by a PACCAR Powertrain distributor. If you aren't an experienced mechanic, or don't have the right equipment, please leave all repairs to a PACCAR Powertrain distributor. They are the ones best equipped to do the job safely and correctly.

dealer from whom you purchased your vehicle.

Maintenance Manuals

If you decide to do any complex repair work, you'll need the maintenance manuals. Order them from your PACCAR Powertrain distributor. Please provide your Chassis Serial Number when you order, to be sure you get the correct manuals for your vehicle. Allow about four weeks for delivery. There will be a charge for these manuals.

Final Chassis Bill of Material

A complete, non-illustrated computer printout listing of the parts used to custom-build your vehicle is available through the

Chapter 2 | FEATURES

Auxiliary Transmission (option).....	14
Auto-neutral.....	14
Clutch Abuse Protection.....	14
Coast Mode.....	14
Creep Mode.....	15
Cruise Control.....	15
Engine Underspeed Protection.....	15
Engine Overspeed Protection.....	15
High-range Reverse (PRO only).....	15
Hill Start Aid (HSA).....	16
Hold Gear Mode (option).....	16
Load-based Shifting.....	16
Low Mode.....	16
MAX Mode.....	17
Neutral Coast Mode.....	17
Optimized Gear Selection.....	17

Transmission Power Take-off (PTO) (option)..... 18
Urge to Move..... 18

Auxiliary Transmission (option)

This transmission can be equipped and configured to utilize an auxiliary transmission. The auxiliary transmission is activated using the auxiliary transmission switch (see [Auxiliary Transmission Switch \(option\)](#) on page 31). See the auxiliary transmission operator's manual for operation of the auxiliary transmission.

Auto-neutral

The Auto-neutral feature will automatically shift the transmission into Neutral if it is left in a forward or reverse mode (such as Low, Drive, or Reverse) and the parking brake is set. The transmission gear display shows **AN** when Auto-neutral is activated.



NOTE

If Auto-neutral has been activated, the transmission will not shift into Drive (**D**) or Reverse (**R**) until the shifter is first

moved to Neutral (**N**) before selecting another transmission mode.

Clutch Abuse Protection

The clutch can overheat with improper use. If clutch temperature is elevated or overheating (see [Clutch Temperature Gauge](#) on page 24), Clutch Abuse Protection will turn on, producing an audible tone and may indicate **CA** in the transmission gear display (option).

When active, Clutch Abuse Protection

- Limits launch gears to 1st and R1
- Disables Urge to Move
- Disables Creep Mode

When Clutch Abuse Protection is active, full clutch actuation must be completed quickly or the clutch will automatically close when the accelerator pedal is pressed and open when it is not. If clutch abuse continues, Clutch Abuse Protection will prevent clutch engagement and temporarily remove control of the accelerator pedal, allowing the clutch to cool down.

Coast Mode

Coast Mode shifts the transmission into neutral when coasting to a stop, providing a smooth stopping experience. When slowing down on level terrain, the transmission will downshift, remaining in gear until it reaches the coast down gear. If the vehicle continues to slow (and the accelerator pedal is not applied), the transmission assumes the operator intends to stop, and shifts into neutral.

Coast Down Gear: 7th

If the accelerator pedal is applied while in Coast Down mode, the transmission will shift into a gear appropriate for the current vehicle operating conditions.



NOTE

The Coast Down Gear can be changed at your PACCAR Powertrain distributor.

Creep Mode

Creep mode allows the vehicle to be driven at a constant speed at engine idle without pressing the accelerator pedal. This feature is useful for slow speed applications where steady vehicle speed is required. Creep speed can be adjusted by upshifting and downshifting the transmission.

Cruise Control



WARNING

DO NOT operate the cruise control when operating on road surfaces with poor traction (wet, icy, or snow covered roads) or in heavy traffic. Accelerations caused by the normal operation of the cruise control could cause you to lose control of the vehicle resulting in an injury accident.

This transmission system is compatible with cruise control. Cruise control functions and features may vary depending on which engine you have.

For a specific explanation of your cruise control, see the cruise control or engine manual included with your vehicle. This vehicle's electronic system will perform a 'rationality check' every time the vehicle is started. This check is to ensure that the service brakes are working before allowing cruise control to function. This safety feature is designed to ensure that a driver is able to cancel the cruise set speed by using the service brake pedal. The system will not allow cruise control operation if it does not pass the 'rationality check.' The display will prompt you to press the service brake pedal if it has not been pressed since the vehicle was turned on.

Engine Underspeed Protection

The transmission will downshift to prevent engine lug (driving in high gear at low rpm) and a potential stall during an engine underspeed condition. Engine underspeed protection is active when in Drive or Manual mode.

Engine Overspeed Protection

The transmission will upshift to prevent an engine overspeed condition. Engine Overspeed Protection is active in Drive, Manual, and Low modes.

High-range Reverse (PRO only)

This transmission supports operation in three high-range reverse gears (R4-R6) providing the higher reverse operating speeds useful for certain vehicle applications. See [Reverse Mode](#) on page 28.



NOTE

The minimum and maximum manual reverse starting gear can be adjusted at a PACCAR Powertrain distributor.

Hill Start Aid (HSA)

Hill Start Aid (HSA) prevents unwanted vehicle movement on steep grades when transitioning from the brake to throttle pedal. HSA can be disabled using the Hill Start Aid Disable switch (see [Hill Start Aid \(HSA\) Disable Switch](#) on page 31). HSA activates by default on a road grade of 2% or greater, but can be configured to activate on a 1% or 3% grade. See [Hill Start Aid Operation \(HSA\)](#) on page 37 for use.

Hold Gear Mode (option)

Hold Gear mode replaces Manual mode and is useful when the operator wants to use the engine braking provided by a specific gear (reducing brake usage) or when the resulting jolt from changing gears might prove unfavorable due to the current driving conditions.

When activated, Hold Gear mode has two available effects:

- If the current gear is lower than the programmed hold gear, the transmission will not upshift further than the programmed hold gear

and will deny any upshift requests that exceed the hold gear (see [Manual Mode](#)).

- If the current gear is equal to or higher than the hold gear, Hold Gear mode will maintain the current gear and deny any shift requests made by the operator (see [Manual Mode](#)).



NOTE

The hold gear can be changed at a PACCAR Powertrain distributor.

Load-based Shifting

This feature will adjust the transmission shift schedule, changing the shift points, based on

- Vehicle weight (load)
- Road grade
- Engine rpm
- Accelerator pedal position

These inputs help determine when to smoothly (and efficiently) shift between gears, improving fuel economy and performance. The transmission then

retains the new shift schedule when making future shifting decisions. If vehicle load changes, load-based shifting will need to set a new shift schedule, adjusting the shift points after the first few shifts. If the operator selects a gear that will result in engine lugging or overspeeding, the shift will be denied.

Load-based shifting can be customized to meet a variety of transmission calibrations (see [Calibration Options](#) on page 61):

- Standard
- Performance
- Tanker



NOTE

A new calibration can be selected at a PACCAR Powertrain distributor. Not all calibration options are available with all engine/transmission model combinations.

Low Mode

Low mode restricts the transmission to first gear, providing additional torque. If activated while moving, Low mode will downshift the transmission, slowing the

vehicle, until first gear is achieved (see [Low Mode Operation](#) on page 38 for use). Use Low mode to

- Stop the vehicle when carrying a heavy load while remaining in gear – this is assisted by activating the engine brake (see [Engine Brake Operation](#) on page 30).
- Maintain smooth, continuous power when going up or down steep grades at a low vehicle speed (10 mph or less).

**NOTE**

Overspeed protection remains active while Low mode is engaged.

MAX Mode

MAX mode applies engine braking and the transmission lower gears to quickly slow the vehicle without using, and potentially overheating, the service brakes or rocking the cab.

**NOTE**

MAX mode is not a substitute for using the service brakes in urgent situations.

When activated, **MAX** displays on the Engine Brake Indicator (see [Engine Brake Indicator](#) on page 23) and the transmission begins downshifting and using 100% engine braking. The transmission stops downshifting in 7th gear, the coastdown gear. See [MAX Mode Operation](#) on page 39 for use.

Neutral Coast Mode

Neutral Coast mode places the transmission into Neutral on slight downhill grades, improving fuel economy. Neutral Coast mode only operates when cruise control is active and the transmission is in Drive.

When Neutral Coast Mode is active, the engine will drop to idle speed and the transmission will disengage. The gear display shows a green **N** when Neutral Coast mode is active. The transmission exits Neutral Coast, returning to an appropriate gear, when the

- Vehicle brake is applied
- Operator depresses accelerator pedal
- A mode other than Drive is selected
- Operator performs an upshift or downshift request
- Cruise control is canceled
- Cruise high or low set speeds are exceeded
- Maximum vehicle grade is exceeded
- Driver Assistance systems (ADAS) make a brake request

Optimized Gear Selection

This feature will automatically select the start gear depending on the following conditions:

- Vehicle weight (load)
- Road grade
- Axle / transmission ratio

The start gear selection can be changed using an upshift or downshift request, as long as the selection requested would not cause transmission damage or engine lugging.

This transmission will shift multiple gears at one time (skip shift) with moderate to high accelerator pedal input while in Drive mode, up to the 18th gear. Unacceptable start gear request will be denied (see [Start Gears](#) on page 35).

i NOTE

If the driver attempts to select a non-neutral mode without applying the service brake, the transmission will not shift into gear. If this is attempted, the driver will need to re-select Neutral (N), and then press the service brake before a new mode can be selected.

i NOTE

If vehicle weight drops (load is removed) while the engine is running, the current start gear is maintained until the vehicle has been driven a short distance. If weight drops with the engine off, the default start gear is used until the vehicle has been driven a short distance. This allows the transmission to adapt to the new weight.

Transmission Power Take-off (PTO) (option)

The transmission may have a PTO installed. Engaging the PTO differs if it is operating in either a mobile or a stationary application (See [Mobile Transmission-PTO Operation \(option\)](#) on page 39 and [Stationary Transmission-PTO Operation \(option\)](#) on page 40 for use).

Urge to Move

At vehicle launch, Urge to Move automatically starts moving the vehicle once a transmission mode is selected (Drive or Reverse) and the service brakes have been released.

After vehicle launch, the vehicle will creep at constant speed in the selected direction (Drive or Reverse) without use of the accelerator pedal (see [Creep Mode](#) on page 15). Urge to Move is useful for stop and go applications.

i NOTE

If an unexpected amount of torque is required to launch the vehicle (for example, if the trailer brakes are engaged) Urge to Move will disable, presenting a popup on the display. To re-enable Urge to Move, place the transmission in Neutral and then back into drive. When the popup disappears, Urge to Move has been re-enabled.

If the torque required to launch the vehicle exceeds the Urge to Move safety threshold, the accelerator pedal can still be used to launch the vehicle.

Chapter 3 | INDICATIONS

3

Digital Display.....	21
Transmission Air Supply.....	21
Popups.....	22
Transmission Gear Display.....	23
Drive, Neutral, and Reverse Indicator.....	23
Auxiliary Transmission - Neutral	23
Engine Brake Indicator.....	23
Hill Start Aid (HSA) Disabled Warning Light.....	24
Transmission Oil Temperature Gauge.....	24
Clutch Temperature Gauge.....	24

Digital Display

The digital display is visible during all driving situations and in some parked situations. When the parking brake is set, the following actions will wake the display, making it visible:

- Opening (or keeping open) the cab doors
- Using steering wheel switches
- Tapping the brake
- Turning the ignition switch to **ON**, **ACC**, or **START**
- Starting the engine

If after 20 seconds, none of these actions are taken, the display will darken to conserve power, but will awaken when any wake action is performed. If the Anti-Theft option is active and you attempt to start the engine, a passcode prompt will appear. The engine cannot be started until the correct passcode is entered.

¹ Configuration depends on model.

Transmission Air Supply



WARNING

Maintain specified transmission air system pressure range between 90 psi (5.9 bar) and 130 psi (9.0 bar). Failure to maintain proper air system pressure could result in degraded or complete loss of transmission engagement and shift capabilities resulting in property damage, serious injury, or death.

Vehicle secondary air controls the shifting range and optional transmission PTO for this transmission.

Secondary Air Pressure Indicator



Maintaining vehicle air in the proper operating range is essential for optimal shift operation and can be monitored using the secondary air gauge on the digital display.

Primary and Secondary Air Gauge¹

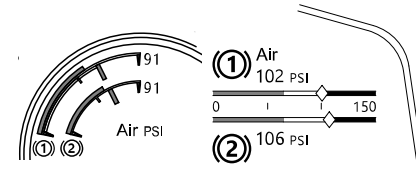

Secondary air pressure can drop as a result of heavy air usage, which can be caused by

- Vigorous brake use
- Filling or dumping an air suspension
- Loading or unloading an air suspension with the engine off
- Raising or lowering lift axles

If a Low Transmission Air condition occurs during operation and the operator performs a shift (between Drive, Neutral, or Reverse), the transmission will shift into Neutral, where it will stay until pressure rises above the minimum threshold for

transmission operation: see [Low Transmission Air](#) on page 22.

Low Transmission Air

A low transmission air condition occurs when secondary air drops below the minimum threshold for proper transmission operation. This may happen

- At engine start
- During heavy secondary air usage

In the event of low transmission air

1. Slow down, carefully.
2. Move a safe distance off the road, and stop.
3. Set the parking brake, but **do not** stop the engine.
4. Turn ON the Hazard Warning Lights, and use other warning devices to alert other motorists.
5. Observe secondary air pressure.
6. Idle engine until pressure returns to the normal operating range, and the Low Transmission Air popup clears.

If secondary air pressure does not return to the normal operating range or the Low Air Alarm activates, do not attempt to drive the vehicle until the problem is found and fixed.

See your vehicle operator's manual for further information on air system leaks.

Popups

A popup communicates information. This could be because a gauge indicates outside of its normal operating range or to notify the operator about a specific truck condition. Popups can be red, amber or white. Red and amber popups are totaled in the Active Warnings Indicator at the top of the display. A popup's characteristics (color, brilliance, and whether it flashes or has an audible alarm) depend on the condition that generated the popup.



1. System – Symbol representing affected system.
2. Title – Notification.
3. Suppressibility – Indicates if the current popup is suppressible using **Select**.

4. Stack Size – The lower number indicates how many popups are in the stack (suppressible and non-suppressible), and the upper, which popup is being viewed.
5. Instructions – Contains instructions or elaborating information.

When multiple popups are present, each is assigned a priority and placed in a stack. Higher priority popups are placed towards the front of the stack. The **Select** button cycles through the active popups, allowing each popup in the stack to be viewed. Some popups, once viewed, are removed from the stack; these popups are called suppressible. Suppressible popups show an “X” below the **Select** icon and typically don't require an immediate response. Suppress these popups using the **Back/Cancel** button (or the **Select** when the parking brake is set). Non-suppressible popups cannot be removed from the stack until the parking brake is set.



NOTE

The menu is not accessible until all popups have been suppressed.²

Transmission Gear Display

Eighth Gear + Manual Mode



The Transmission Gear Display is located on the digital display and can show the transmission mode, current gear, and important transmission conditions:

1 – 18	Forward Gear
R1 – R3	Reverse Gear
R4 – R6 (Pro only)	High-range Reverse
AN	Auto Neutral
CA	Clutch Abuse
L	Low Mode
M	Manual Mode

N	Neutral
N (green)	Neutral Coast
–	Shift Position Unknown
!	Error State
**	Data Loss ³

Drive, Neutral, and Reverse Indicator



N
R

The Drive, Neutral, and Reverse Indicator reflects the shifter position for automatic and automated transmissions. Manual transmissions and certain automatic transmissions do not provide feedback to the display. Instead, the transmission shifter indicates the gear condition.

Auxiliary Transmission - Neutral



Indicates the auxiliary transmission is engaged and in neutral.

Engine Brake Indicator



This indicator appears when engine braking (compression brake or exhaust brake) is enabled. Vehicles capable of changing the amount of engine braking show available engine braking levels below the indicator, with the selected braking level highlighted. When actively engine braking, the engine brake indicator turns

² All popups become suppressible when the parking brake is set.

³ Can show briefly at initial key on.

green. Active engine braking can be overridden when the operator (or a truck feature, such as Adaptive Cruise Control (ACC)) provides acceleration. In these cases, the engine brake indicator will turn white (enabled but not active) while acceleration is being applied.

Hill Start Aid (HSA) Disabled Warning Light



This warning means that the Hill Start Aid (HSA) feature is disabled. This may be from use of the Hill Start Aid Disable switch (see [Hill Start Aid Disable Switch](#)) or a fault with the HSA feature.

Transmission Oil Temperature Gauge



The optional Transmission Temperature Gauge indicates the temperature of the oil in the transmission. Watch this gauge to know when the transmission is overheating. If so, have it checked by an authorized service representative.

Clutch Temperature Gauge

The clutch temperature gauge monitors the temperature of the clutch, which increases during clutch engagement and disengagement:

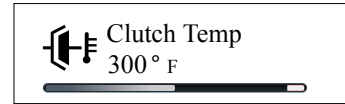

The gauge is located on the digital display and reacts to the indicated temperature. If the clutch temperature gauge has not been configured to show normally, it may appear when clutch temperature enters the elevated or overheated range.

The Clutch Temperature Gauge has three states:

- No glow — normal operating range.
- White glow — clutch temperature elevated.
Reduce clutch use to prevent overheating (see [Proper Clutch Use](#) on page 36). **CA** may appear in the transmission gear display.
- Red glow — Clutch overheated: discontinue vehicle operation (see [High Clutch Temperature](#) on page 24).

High Clutch Temperature

1. Slow down, carefully.

⁴ Configuration depends on model.

2. Move a safe distance off the road and stop.
3. Place the transmission in neutral, set the parking brake, but **do not** stop the engine.

**NOTE**

Allow engine to idle. Turning off the engine prolongs the clutch high temperature condition.

4. Turn on the hazard lights, and use other warning devices to alert motorists.
5. Idle engine until clutch temperature returns to normal operating range.

Chapter 4 | CONTROLS

Column Shifter.....	27
Hill Start Aid (HSA) Disable Switch.....	31
Power Take-off (PTO) Switch (option).....	31
Auxiliary Transmission Switch (option).....	31

Column Shifter

The column shifter, located on the right-hand side of the steering column, lets the operator perform the following transmission functions:

- Switch transmission modes
- Upshift and Downshift
- Activate Manual mode
- Activate Hold Mode (option)
- Activate Low mode
- Activate MAX mode

Transmission Modes

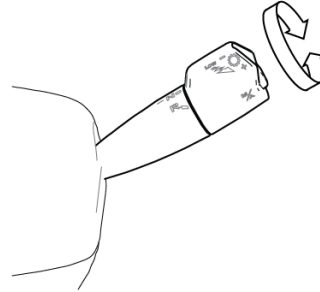

Select the transmission mode by rotating the shifter outer knob. There is a position for Drive (**D**), Neutral (**N**), Reverse (**R**). Rotating the knob to the Reverse (**R**) position while moving forward, or to the Drive (**D**) position while moving backward, will not change the transmission mode to those selections.

The Digital Display will indicate the corresponding mode.



NOTE

Selector (the transmission) must be in Neutral (**N**) to start the truck.

Neutral Mode

- Selects Neutral.
- Initial Gear position after Start-Up.



WARNING

Apply parking brake and follow vehicle manufacturer parking instructions. Failure to follow these instructions could cause unintended vehicle movement resulting in death, serious injury or damage to property.



NOTE

If the engine does not crank at start-up, confirm the following:

- Neutral is selected.
- The vehicle parking brake is applied.
- The service brake is depressed.

Drive Mode (Auto Mode)

Optimized Gear Selection automatically selects the start gear depending on inputs such as, load, grade, and axle/transmission ratio. This start gear can be changed by making an upshift or downshift request, unless the start gear requested would cause damage to the transmission during vehicle launch.



NOTE

If the driver attempts to select a non-neutral mode without applying the service brake, the transmission will not shift into gear. If this is attempted, the driver will need to re-select Neutral

(**N**), and then press the service brake before a new mode can be selected.

If the start gear is changed using an upshift or downshift request, the request will remain the default start gear until the vehicle is powered down or the selection is changed; however, conditions such as grade may still override the default start gear selection.

A shift can be advanced by using an upshift or downshift request when the transmission is near the shift point.



NOTE

Multiple upshift or downshift requests may be allowed when the upshift/downshift request procedure is performed multiple times in succession. Each push or pull of the column shifter equals one gear change request.

The transmission may also deny a shift while ascending or descending grades if the vehicle load and grade of the terrain, in combination with the drivetrain ratio and engine torque, will fall outside of the acceptable range to perform a shift. If the shift is denied, a tone will sound.

Reverse Mode

- Reverse mode selects the default Reverse gear.



NOTE

If the driver attempts to select a non-neutral mode without applying the service brake, the transmission will not shift into gear. If this is attempted, the driver will need to re-select Neutral (**N**), and then press the service brake before a new mode can be selected.

- Each time Reverse is selected from Neutral, the default Reverse gear is engaged.

High-range Reverse (Pro Only)

Using High-range Reverse When Stationary

1. Select Reverse (**R**) on the column shifter.
2. Upshift repeatedly until **R3** indicates on the transmission gear display.

**NOTE**

When stationary, R3 is available to launch the vehicle. Once the vehicle is moving, R4 through R6 can be selected.

Using High-range Reverse When Moving

- Upshift until the desired high-range gear is obtained.

**NOTE**

Applying the service brakes while downshifting from high range to low range is recommended to aid the shift.

Upshifting and Downshifting

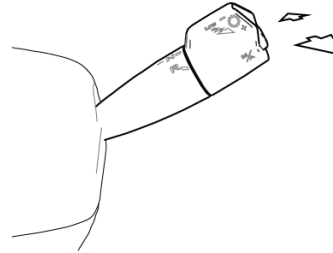

The transmission gear can be selected manually to accommodate the driving needs of the operator. The transmission mode must be in either Drive or Reverse to manually select the gear.

When in Automatic mode

- Pushing or pulling the shifter will briefly upshift or downshift the transmission (for about four seconds); after which, the transmission will return to the ideal gearing for the current vehicle speed and engine use.

- Pushing and holding the shifter away will engage the Low mode (see [Low Mode Operation](#) on page 38).

When in Manual mode

- Pulling the shifter towards the operator (+) will upshift.
- Pushing the shifter away (-) will downshift.
- Pushing and holding the shifter away (-) will engage Low mode (see [Low Mode Operation](#) on page 38).

The selected gear will appear on the Transmission Gear Display (see [Transmission Gear Display](#) on page 23) and may flash briefly when moving into gear.

Manual and Automatic Modes

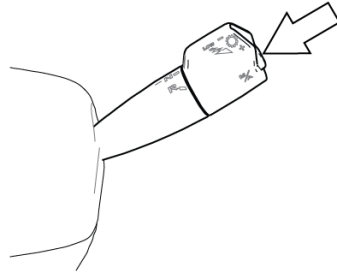

Pressing this button places the transmission in Manual mode. Manual mode allows the operator to select the gear (See [Upshifting and Downshifting](#) on page 29).

To activate, place the column shifter in Drive mode (D), and then depress the Manual Mode Button. When Manual mode is selected, an **M** is shown in the Transmission Gear Display (See [Transmission Gear Display](#) on page 23).

If Hold Gear mode is optioned, the Manual Mode Button activates Hold Gear mode (see [Hold Gear Mode \(option\)](#) on page 16).

Exiting Manual Mode

To exit Manual mode

- Press the Manual Mode Button
- Place the column shifter in Neutral (N)

Transmission Manual Override

If the vehicle is being back-driven and the engine is approaching a higher than acceptable engine operation range, the transmission system will override Manual mode and perform an upshift.

	NOTE
The transmission initiates upshifts from Drive, Manual, and Low modes for engine overspeed protection.	

If the start gear is changed and it causes the engine to lug at takeoff, the transmission system will override Manual mode and perform a downshift.

Engine Brake Operation

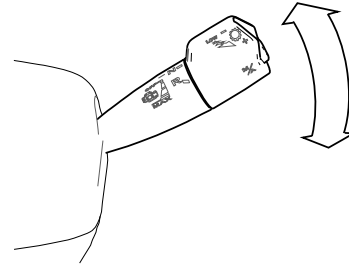

Moving the shifter down (clockwise) will engage the engine brake, with each downward position providing more engine braking. The bottom-most position (Position 4) is a momentary position and activates MAX mode.

Position	Amount of Engine Brake
Off	0 %
1	33%
2	66%

Position	Amount of Engine Brake
3	100%
4*	100% AND engages MAX mode.

The corresponding engine brake level (and MAX mode) indicates on the engine brake indicator.

Hill Start Aid (HSA) Disable Switch

Two-position Switch



Positions:

- **OFF** (temporary position)
- (center, resting position)

OFF Pressing the switch up temporarily disables the Hill Start Aid feature. Disabling Hill Start Aid presents both a Popup and a warning light (see

* This position is momentary and will revert back to position 3 when the shifter is released.

Hill Start Aid (HSA) Disabled Warning Light on page 24).

Hill Start Aid is automatically re-enabled after the first successful launch.

Power Take-off (PTO) Switch (option)

Two-position Switch



Positions:

- **ON**
- **OFF**

ON Enables the PTO, starting the PTO activation process.

OFF Disables the PTO.

This vehicle may be equipped with a dash-mounted switch that controls PTO engagement/disengagement. When the operator activates the switch for the PTO, the status indicator light (located on the

switch) will immediately illuminate even though PTO engagement may not have occurred. If the PTO is engaged and the operator turns the switch **OFF**, the PTO status indicator light (located on the switch) will turn off immediately even though PTO disengagement may not have occurred.



CAUTION

Increasing engine rpm before the PTO is engaged can prevent the PTO from engaging and/or cause PTO damage.

Auxiliary Transmission Switch (option)

Three-position Switch



Positions:

- **LOW**

- **N** (Neutral)
- **OFF**

LOW Engages the auxiliary transmission.

Switch lights up when active.

N Disengages the driveline.

Switch lights up when active, and the Auxiliary Transmission - Neutral indicator is shown (see [Auxiliary Transmission - Neutral](#) on page 23).

OFF Disengages the auxiliary transmission.

This vehicle may be equipped with a dash-mounted auxiliary transmission activation switch. Vehicle speed must be less than 7 mph (12 kph) for the auxiliary transmission to accept a change in switch position; therefore, switch position does not necessarily represent the state of the auxiliary transmission.

When switch is lit, verify the presense (or absence) of the Auxiliary Transmission - Neutral Indication (see [Auxiliary Transmission - Neutral](#) on page 23) on the display after changing switch position.

Chapter 5 | OPERATION

General Operation.....	35
Hill Start Aid Operation (HSA).....	37
Low Mode Operation.....	38
MAX Mode Operation.....	39
Transmission-PTO Operation.....	39
Snow/Ice Operation.....	40
Trailer Operation.....	41
Vehicle Towing.....	41

General Operation

Start Gears

This transmission can be launched in the following start gears:

Drive	1 st – 5 th
Reverse	R1 – R3

Start-Up



CAUTION

Never operate the starter motor while the engine is running. The starter and flywheel gears could clash or jam, severely damaging them.



NOTE

Some starters are equipped with over-crank protection. Check the Engine Operation and Maintenance Manual for details.

1. Set the parking brake.
2. Ensure that Neutral is selected for the transmission mode, and that **N** indicates on the display.



NOTE

The transmission will not allow the engine to crank if a mode other than Neutral is selected, on transmission shifter, when attempting to start the engine.

3. Turn the ignition switch to **ON** and allow the transmission to power-up.



NOTE

Engine cranking is delayed until the transmission power-up is complete and the gear display shows a solid **N**. If Neutral (**N**) is not shown in the gear display, ensure that secondary air pressure has met the minimum threshold for transmission operation. The Transmission Air Low popup will indicate on the display until secondary air pressure has met the minimum threshold. Wait until the popup disappears before attempting to drive the vehicle.

4. Start the engine.
If the engine does not start within 30 seconds, release the ignition switch. To avoid overtaxing the starter motor or the batteries, don't use the starter for more than 30 seconds. Let the starter motor cool and the batteries recover for two minutes before trying again. If the engine still won't start after a couple of tries, check the fuel lines for possible fuel starvation or

airleaks. Starting failure may mean fuel is not reaching the injectors.

5. Watch the oil pressure gauge.⁵ If oil pressure doesn't rise within a few seconds, stop the engine. Find out what is wrong before restarting the engine.
6. Allow secondary air pressure to build to the normal operating range (100 – 130 psi).
7. Apply service brake.

i NOTE

If the service brake is not applied while selecting a starting gear, the initial start gear will not be engaged and the driver will have to reselect Neutral and press the brake while re-selecting the desired mode.

8. Select the desired mode and starting gear on the transmission shifter.

i NOTE

The transmission automatically selects an appropriate starting gear and will override unsuitable start gear selections to avoid driveline damage (see [Start Gears](#) on page 35).

9. Release the vehicle parking brakes.
10. Release service brake and Urge to Move will allow the vehicle to automatically launch and creep at constant engine idle.
 - Upshifts and downshifts can be made while at constant engine idle by utilizing the up/downshift request procedure. The transmission may deny a shift and sound a tone if the load of the vehicle or grade of the terrain falls outside the acceptable range to perform a shift.

Proper Clutch Use

This transmission uses an automated clutch to launch the vehicle; however, the clutch can still overheat with improper use. To avoid overheating the clutch, observe the following best practices: If moving slow is desired, use Creep mode or select the lowest possible start gear for the application (see [Creep Mode](#) on page 15).

- DO NOT continually start and stop, especially when loaded.

When launching on an incline, use the service brakes and Hill Start Aid (see [Hill Start Aid Operation \(HSA\)](#) on page 37).

- DO NOT use the throttle to hold the vehicle on an incline.
- DO NOT use the accelerator pedal to stop roll-back after Hill Start Aid disengages. Use the service brakes and then relaunch.

Minimize the time it takes to engage the clutch from rest.

If the clutch starts to overheat, the clutch temperature gauge will react and a popup will appear accompanied by a warning tone (see [Clutch Abuse Protection](#) on page 14).

⁵ Check your engine manufacturer's operator's manual for the right pressure for your engine.

Power Down**WARNING**

When parking a vehicle, fully raise lift axles that are not equipped with parking brakes. If left in the down position, a lift axle not equipped with a parking brake could cause the parked vehicle to roll, resulting in an accident. Failure to comply may result in property damage, personal injury, or death.

The information provided in this topic is intended to enhance or amend the Engine Shutdown Procedure, Stopping the Vehicle, and Final Stopping Procedures located in the Engine Operator's Manual and Chassis Operator's Manual specific for your vehicle. Familiarize yourself with the information in this topic, and make the appropriate adjustments to those procedures, if necessary, when shutting down the engine.

1. Place the transmission in neutral (N).

**NOTE**

The transmission should always be in Neutral before powering down, except in emergency situations.

If the transmission gear display does not show a solid **N**, the transmission is not in Neutral.

2. Set the parking brake.

**WARNING**

DO NOT use the service brakes or trailer hand brakes to hold a parked vehicle. Because these brakes rely on air pressure, a loss of pressure could loosen the brakes and cause the vehicle to roll, resulting in an accident. Always set the parking brakes. Failure to comply may result in property damage, personal injury, or death.

**WARNING**

DO NOT leave the transmission in gear to hold a parked vehicle. Always set the parking brake. Engine com-

pression may not provide sufficient force to hold the vehicle, or the transmission may move out of gear, causing the vehicle to roll and result in an accident. Failure to comply may result in property damage, personal injury, or death.

3. Cool down, and then turn OFF the engine.

**CAUTION**

DO NOT shut off the engine immediately after use, especially after a long trip or if the engine has been subject to high load. The engine is hot and must be cooled. Idle the engine at 1000 rpm for at least 4 minutes, then low idle for an additional 30 seconds before shutting off the engine. Failure to comply may result in engine damage, reducing its service life.

Hill Start Aid Operation (HSA)

The Hill Start Aid feature is enabled by default but can be temporarily disabled by

pressing and releasing the Hill Start Aid Disable Switch (see [Hill Start Aid \(HSA\) Disable Switch](#) on page 31).

Vehicle Facing Uphill – Forward Mode

Vehicle must be on an incline of 2% or greater and in a forward mode.

1. Bring vehicle to a stop and depress the service brakes.
2. Release the service brakes to launch the vehicle.



WARNING

After Hill Start Aid releases, apply the vehicle service brake to remain stopped, or use the accelerator pedal to launch the vehicle. Failure to do so could result in unintended vehicle movement resulting in property damage, personal injury, or death.

Vehicle Facing Downhill - Reverse Mode

Vehicle must be on a decline of 2% or greater and in Reverse mode.

1. Bring vehicle to a stop and depress the service brakes.
2. Release the service brakes to launch the vehicle.



WARNING

After Hill Start Aid releases, apply the vehicle service brake to remain stopped, or use the accelerator pedal to launch the vehicle. Failure to do so could result in unintended vehicle movement resulting in property damage, personal injury, or death.

Low Mode Operation



WARNING

On slippery surfaces, minimize engine braking in Low mode. Excessive engine braking at higher engine rpm may cause a loss of traction and vehicle control. Failure to comply may result in property damage, personal injury, or death.



NOTE

Activating Low mode while using cruise control will downshift the transmission into the lowest gear that also maintains vehicle speed above the cruise control minimum speed set-point, keeping cruise control active. Canceling cruise control allows the transmission to downshift into the lowest gear.

This procedure begins at engine start, selecting the lowest available gear. If Low mode is selected while moving, the transmission will downshift at the earliest opportunity, using the higher-than-normal engine rpm to provide maximum engine braking.

1. Start the vehicle.
2. Press and hold the service brake.

**NOTE**

If the driver attempts to select a non-neutral mode without applying the service brake, the transmission will not shift into gear. If this is attempted, the driver will need to re-select Neutral (N), and then press the service brake before a new mode can be selected.

3. Release the parking brake.
4. Push and hold the shifter in the downshift position until **L** appears on the Transmission Gear Display, and then release the service brake.

The vehicle will remain in Low mode until the operator either

- Presses the Manual Mode Button (see [Manual and Automatic Modes](#) on page 30).
- Pushes the column shifter away until **L** is removed from the Transmission Gear Display (see).
- Shifts into (or through) Neutral (**N**).
- Turns the ignition switch to **OFF**.

MAX Mode Operation

Use this feature when a situation requires 100% engine brake and the additional resistance from using the transmission lower gears.

1. Move the transmission shifter to the 3rd position, enabling 100% engine braking.
2. Pull the transmission shifter down again and allow the shifter to move back up to the previous position (3rd position).

Engine Brake + MAX



The vehicle will remain in Max mode until the transmission downshifts into the coast-down gear (5th gear), or the operator

- Presses the accelerator pedal.
- Upshifts, see [Upshifting and Downshifting](#) on page 29.
- Reduces the engine brake level.
- Attempts to activate MAX mode again (pulling the column shifter

down to the temporary 4th position).

- Selects Neutral (**N**) (see [Transmission Modes](#) on page 27).
- Selects Low mode (see [Low Mode Operation](#) on page 38).

Transmission-PTO Operation

Mobile Transmission-PTO Operation (option)

Limited mobile PTO operation is available in start gears (1st - 5th and R1 - R3) using the input shaft driven PTO. To engage the transmission PTO for mobile operation, perform the following:



CAUTION

DO NOT operate the transmission at an operating angle greater than 12° (approximately 21% road grade). The operating angle is the transmission mounting angle plus the road grade expressed as an angle. Failure to comply will result in improper transmission lubrication and may result in equipment or property damage.

1. Bring the vehicle to a complete stop and depress the service brake.
2. Place the transmission in Neutral (N).
3. Select the Transmission PTO switch.
4. Select the transmission mode (Drive or Reverse) and gear required for vehicle movement.



NOTE

Gear shift requests can not be made when the PTO is active, once the vehicle is moving.

5. Release the service brake to engage the clutch and the PTO.
6. Raise engine speed as required to operate PTO.



NOTE

Use the transmission PTO switch to disengage the PTO.

Stationary Transmission-PTO Operation (option)



CAUTION

DO NOT operate the transmission at an operating angle greater than 12° (approximately 21% road grade). The operating angle is the transmission mounting angle plus the road grade expressed as an angle. Failure to comply will result in improper transmission lubrication and may result in equipment or property damage.

The transmission countershaft PTO is used in this application. To engage the PTO for stationary operation, perform the following steps:



WARNING

Apply parking brake and follow vehicle manufacturer parking instructions. Failure to follow these instructions could cause unintended vehicle movement resulting in death, serious injury or damage to property.

1. Bring the vehicle to a complete stop and apply the parking brake.
2. Place the transmission in neutral (N).
3. Select the transmission PTO switch.
4. Raise engine speed as required to operate PTO.



NOTE

Use the transmission PTO switch to disengage the PTO.

Snow/Ice Operation

This transmission is designed to work in coordination with the Automatic Traction Control (ATC) system to ensure optimal

operation. However, if the driver observes low friction road conditions (such as snow, rain, ice) and does not want the transmission to shift, risking wheel slippage, the driver should select Manual Mode. Manual Mode holds the current gear position under most operating conditions- the transmission will only shift when the driver makes an upshift or downshift request. Once road conditions improve, the driver should revert back to Drive Mode.

Trailer Operation

Trailer Connecting

- Prior to backing under the trailer, ensure proper trailer height.
- Use Low mode (1st gear) for forward direction and Reverse (R1) for reverse direction.

Sliding Trailer Axle

- Ensure axle rails and locks are properly maintained.
- Follow proper procedure for unlocking and sliding the trailer axles.

- Use Low mode (1st gear) for forward direction and Reverse (R1) for reverse direction.
- Avoid repeat attempts if the sliding axle is not moving.

proper towing procedures could result in damage to the transmission.



NOTE

If repeat attempts are made and the automated clutch starts to overheat, the display will indicate **CA** along with a warning tone.

Vehicle Towing

When towing the vehicle, the output shaft of the transmission must not be allowed to spin or turn. If the vehicle is towed with the drive wheels still in contact with the road surface, the vehicle axle shafts or driveline must be removed or disconnected.



CAUTION

Always follow proper manufacturer towing procedures. Failure to follow

Limited Driveline-connected Towing

Limited Driveline-connected Towing requirements have been met.



CAUTION

Towing the vehicle with the driveline connected and failing to obey the following Limited Driveline-Connected Towing requirements will damage the transmission and void the transmission warranty.

Vehicle and transmission requirements:

- Secondary air pressure is greater than 90 psi (620 kPa).
- Neutral (**N**) is selected on column shifter.
- A solid **N** (Neutral) indicates on the digital display.
- Ignition switch is in the **OFF** position.

Speed and distance requirements:

- Towing speed is less than 25 mph (40 km/h).
- Towing distance is less than 0.25 mile (0.40 km).

In an urgent situation, the vehicle may be towed with the driveline connected and the drive wheels in contact with the road if the

Chapter 6 | MAINTENANCE

Preventative Maintenance.....	45
Weekly Checks.....	47
Every 7,500 mi / 12,000 km.....	47
Every 30,000 mi / 48,000 km.....	48
Every 60,000 mi / 96,000 km / 6 mo.....	48
Annually.....	49
Every 240,000 mi / 384,000 km / 3 yr.....	49
Every 500,000 mi / 800,000 km / 5 yr.....	50
Air Compressor.....	50
Air Dryer Oil-coalescing Cartridge.....	51
Cooling System Maintenance.....	51
Lubrication.....	54
Troubleshooting.....	57

Preventative Maintenance

Preventive maintenance begins with the daily checks listed in your vehicle operator's manual. Routine vehicle checks can help avoid many large, expensive, and time consuming repairs, and will contribute to better, safer, and longer vehicle operation. Neglect of recommended maintenance can void your vehicle's warranty. Some maintenance operations demand skills and equipment you may not have. For such situations, please take your vehicle to a PACCAR Powertrain distributor.



WARNING

Before attempting any procedures in the engine compartment, stop the engine and let it cool down. Hot components can burn skin on contact. Failure to comply may result in death, personal injury, equipment or property damage.



WARNING

If the engine must be running to inspect, be alert and cautious around the engine at all times. Failure to comply may result in death, personal injury, equipment or property damage.



WARNING

If work must be done with the engine running, always

- Ensure that the transmission is in Neutral (N) (or Park (P))
- Set the parking brake
- Block the wheels

Failure to comply may result in death, personal injury, equipment or property damage.



WARNING

Exercise extreme caution to prevent neckties, jewelry, long hair or loose clothing from getting caught in the fan blades or other moving engine parts. Failure to comply may result in death,

personal injury, equipment or property damage.



WARNING

Always support the vehicle with appropriate safety stands if it is necessary to work underneath the vehicle. A jack is not adequate for this purpose. Failure to comply may result in death, personal injury, equipment or property damage.



WARNING

When working underneath the vehicle without appropriate safety stands but with the wheels on the ground (not supported), make sure that

- The vehicle is on hard, level ground.
- The parking brake is applied.
- All wheels are blocked (front and rear).
- The ignition key is removed to prevent the engine from starting.

Failure to comply may result in death, personal injury, equipment or property damage.



WARNING

NEVER start or let the engine run in an enclosed, unventilated area. Exhaust fumes from the engine contain carbon monoxide, a colorless and odorless gas. Carbon monoxide can be fatal if inhaled. Failure to comply may result in property damage, personal injury, or death.



CAUTION

DO NOT operate the transmission at an operating angle greater than 12° (approximately 21% road grade). The operating angle is the transmission mounting angle plus the road grade expressed as an angle. Failure to comply will result in improper transmission lubrication and may result in equipment or property damage.

The tables on the following pages contain maintenance tasks. These tasks should be performed at the interval labeled at the top of the table, which are based either on vehicle mileage, or vehicle mileage and time passed since the last time that task was performed. Some tasks depend on vehicle application -- or how and where the vehicle is operated. These tasks will have the words ON-HIGHWAY, OFF-HIGHWAY, CITY DELIVERY, or VOCATIONAL after the description and should be performed if the vehicle is operated for that application:

- ON-HIGHWAY – Applications where the vehicle is only used on paved roads during normal operation.

- OFF-HIGHWAY – Applications where the vehicle may be driven off the pavement on a regular basis, even if it is an infrequent basis and/or for a brief time period.
- CITY DELIVERY – Applications where frequent start and stopping is required during normal operation, and highway use is infrequent and for short intervals.
- VOCATIONAL – Applications based on truck configuration and use and not on operating environment. Vocational vehicle components must meet the requirements needed for its specific application (such as delivery, construction, fire service, refuse, and busing). A truck can be Vocational in addition to other application types. Vehicles that fall into more than one application category should observe the earliest and more limiting application's maintenance requirements.

VOCATIONAL door-to-door refuse applications **are not** approved for this transmission.

OFF-HIGHWAY applications are approved for the **PRO configuration only**.

This transmission uses a coolerless design; however, vehicles that are

- 110,000 lbs GCW or greater
- equipped with specific PTOs
- used in certain vehicle applications or environments

require a transmission lubricant cooler. The oil cooler maintenance listed in the Preventative Maintenance Schedule is for

vehicles equipped with a transmission lubricant cooler. If there are questions regarding which intervals to follow, please contact a PACCAR Powertrain distributor. Consult the supplier for specific recommendations where discrepancies develop between the recommendations in the following maintenance tables and the component supplier recommendations.

Weekly Checks



NOTE

These checks are in addition to, not in place of, Federal Motor Carrier Safety Regulations. These regulations may be purchased by writing to: Superintendent of Documents U.S. Govern-

ment Printing Office Bookstore 710 N. Capitol St. N.W. Washington, DC 20402, or ContactCenter@gpo.gov.

Transmission

Perform the following checks in addition to those checks listed in the vehicle operator's manual.

- Transmission (VOCATIONAL) - Inspect exterior for leaks.
- Transmission (VOCATIONAL) - Check the oil level: refill as required (See for maintenance instructions).
- Transmission (VOCATIONAL) - Inspect oil filter and exterior seals for damage: replace as necessary.

Every 7,500 mi / 12,000 km

Every 7,500 mi / 12,000 km

Main and auxiliary Transmission - Lubrication (ON-HIGHWAY and CITY DELIVERY)

- Inspect exterior for leaks.
- Check the oil level: refill as required (See [Lubrication](#) on page 54 for maintenance instructions).
- Inspect exterior seals for damage, and replace as necessary.

Every 30,000 mi / 48,000 km

Every 30,000 mi / 48,000 km ⁶
Air - Air Compressor Governor <ul style="list-style-type: none">• Replace air strainer (See Air Compressor on page 50 for maintenance instructions).
Air - Air Lines <ul style="list-style-type: none">• Check condition and routing to prevent chafing (See Air Compressor on page 50 for maintenance instructions).

6

Every 60,000 mi / 96,000 km / 6 mo

Every 60,000 mi / 96,000 km / 6 mo ⁷
Air - Inline Filters <ul style="list-style-type: none">• Replace elements or clean with solvent (Refer to "Replace Engine Air Filter" located in your engine operator's manual).

⁶ Ensure that all maintenance intervals leading up to this point are repeated during this interval prior to the completion of those listed here.

⁷ Ensure that all maintenance intervals leading up to this point are repeated during this interval prior to the completion of those listed here.

Every 60,000 mi / 96,000 km / 6 mo⁷

Main and Auxiliary Transmission - Mounting Brackets and Fasteners

- Check the condition of the fasteners and their torque. Tighten to the specified torque value as required. (Refer to [Frame Fastener Torque Requirements](#) on page 63 for maintenance instructions.

Main and auxiliary Transmission - Oil Cooler

- Clean the fins (air-to-oil type) and body. Check the hose condition and for leaks: replace as required (See [Cooling System Maintenance](#) on page 51).

Annually**Annually**

Air - Air Dryer (Oil-coalescing Desiccant Cartridge)

- Replace cartridge annually regardless of mileage (See [Air Dryer Oil-coalescing Cartridge](#) on page 51).

6

**Every 240,000 mi / 384,000
km / 3 yr**

⁷ Ensure that all maintenance intervals leading up to this point are repeated during this interval prior to the completion of those listed here.

Every 240,000 mi / 384,000 km / 3 yr⁸

Main and auxiliary Transmission - Lubrication (VOCATIONAL)

- Drain and replace lubricant (See [Draining the Transmission](#) on page 54).

Every 500,000 mi / 800,000 km / 5 yr

Every 500,000 mi / 800,000 km / 5 yr⁹

Main and auxiliary Transmission - Lubrication (ON-HIGHWAY and CITY DELIVERY)

- Drain and replace lubricant (See [Draining the Transmission](#) on page 54).

6

Air Compressor

All compressors, regardless of make or model, run continuously while the engine is running. System pressure is controlled by the governor. The governor acts in conjunction with the unloading mechanism in the compressor cylinder block to start

and stop compression of air. The compressor is unloaded when the system pressure reaches 130 psi (896 kPa), and compression is reestablished when system pressure falls to 110 psi (758 kPa).

Preventive Maintenance

The following service checks are provided for informational purposes, and should only be performed by a certified mechanic.

Contact your dealer or the engine manufacturer's maintenance manual for further information on servicing air compressors. After completing any repairs to the air system, always test for air leaks, and check the brakes for safe operation before putting the vehicle in service. Below is a list of areas to maintain for the air compressor:

⁸ Ensure that all maintenance intervals leading up to this point are repeated during this interval prior to the completion of those listed here.

⁹ Ensure that all maintenance intervals leading up to this point are repeated during this interval prior to the completion of those listed here.

- Inspect compressor air filter element, if equipped, and replace element if clogged. Check compressor mounting and drive for alignment and belt tension. Adjust if necessary.
- Remove compressor discharge valve cap nuts and check for presence of excessive carbon. If excessive carbon is found, clean or replace the compressor cylinder head. Also, check compressor discharge line for carbon, and clean or replace the discharge line if necessary.
- Disassemble compressor and thoroughly clean and inspect all parts. Repair or replace all worn or damaged parts, or replace compressor with a factory exchange unit.

Transmission Air Supply

For optimal performance, this transmission requires a nominal air supply operating range between 90 psi (5.9 bar) and 130 psi (9.0 bar).

 **WARNING**

Maintain specified transmission air system pressure range between 90 psi (5.9 bar) and 130 psi (9.0 bar). Failure to maintain proper air system pressure could result in degraded or complete loss of transmission engagement and shift capabilities resulting in property damage, serious injury, or death.

Air Dryer Oil-coalescing Cartridge

The air system supplying this component is equipped with an oil-coalescing air dryer. The air dryer's oil-coalescing cartridge must be replaced yearly, regardless of mileage.

 **CAUTION**

Replace the oil-coalescing desiccant air dryer cartridge annually, regardless of mileage. Use only an oil-coalescing

desiccant cartridge as a replacement. Failure to comply will void the transmission warranty and may cause transmission damage.

Cooling System Maintenance

The cooling system in your vehicle was factory filled with extended life coolant that meets or exceeds all ASTM D6210 and Caterpillar EC-1 requirements. PACCAR recommends only using a 50:50 mixture of distilled water and ELC when cooling system service is required. A 50:50 mixture of extended life coolant (ELC) and distilled water will provide freeze protection down to -34 °F (-36.7 °C), which is adequate for most locations in North America. For extremely cold operating conditions, a 60:40 mixture (coolant/water ratio) can be used to provide freeze protection down to -62 °F (-52.2 °C). Unless otherwise optioned, factory fill coolant is an ethylene glycol, nitrated organic acid technology (NOAT) extended life coolant (ELC) formulation at a 50:50 coolant-to-distilled water mixture. The factory fill meets or exceeds ASTM D6210

and Cummins Engineering Standard 14603 for ISX and PX engines, and MAT74002 for PACCAR MX-11 and MX-13 engine requirements. Maintaining coolant chemistry and freeze protection is critical to engine and cooling system component health and longevity.



WARNING

Coolant is toxic. DO NOT get the fluid in eyes. If contact occurs, flood eyes with large amounts of water for 15 minutes. Avoid prolonged or repeated contact with skin. In case of contact, immediately wash skin with soap and water. DO NOT take internally. If swallowed, seek immediate medical attention. DO NOT induce vomiting. Failure to comply may result in death, personal injury, equipment or property damage.



CAUTION

The engine cooling system has very specific maintenance and inspection requirements. Failure to follow requirements can damage the engine. Engine

damage can include but is not limited to freezing, boiling, corrosion, pitted cylinder liners. This information is found in the engine manufacturers owner's manual. It is the owner's responsibility to follow all requirements listed in the engine manufacturers owner's manual.



NOTE

Coolant is harmful to the environment. Unused coolant must be stored as a toxic hazardous material in leakproof containers. Used coolant must be processed as industrial chemical waste. Please follow HAZMAT guidelines with both used and unused coolants.



CAUTION

Use of non-genuine PACCAR coolant filters can cause severe engine damage.

Concentration

Check the level of freeze/boil-over protection, which is determined by the glycol concentration. Use a glycol refractometer to determine glycol level. Add coolant to obtain the coolant/water ratio required to provide the protection you need. A 50:50 mix of coolant and water is adequate for most applications. For extremely cold operating conditions, the ratio can be adjusted to a higher concentration of coolant.



NOTE

Maximum recommended ELC concentration is 60% ELC and 40% water by volume (a 60:40 coolant mixture). The minimum recommended concentration is 40%.

Glycol Concentration Level

Level	Desired Coolant / Water Ratio	Freeze Point °F (°C)
Recommended Levels	40%	-12 (-24)
	45%	-23 (-31)
	50%	-34 (-37)
	55%	-50 (-46)
	60%	-62 (-52)

Condition

Perform a visual inspection of the coolant. It should have no cloudiness or floating debris. Determine the chemical inhibitor concentration level by using an ELCt specific test kit or test strips. Inhibitor concentration level determines corrosion protection. If you are concerned about possible coolant quality, contamination, or mechanical problems, submit a coolant sample for analysis. Improper maintenance may cause coolant degradation and could

result in damage to the cooling system and engine components. Consult your dealer or the coolant manufacturer's representative for recommended ELC test kits, test strips, and laboratory sample procedures.

Coolant Extender

Add ELC extender, if necessary, according to the corrosion inhibitor concentration required. DO NOT add coolant extender to nitrite-free coolant.

Checking Coolant Level

Check the coolant level daily. When adding coolant, avoid mixing different brands and formulations. If the coolant is mixed with more than 25% of a different formulation, engine corrosion damage can occur. If mixing exceeds 25% of total system volume, it is recommended to flush and refill the system completely with one type of coolant.

Coolant Filter

Your engine may be equipped with a coolant filter. It is a "blank filter" and does not contain chemicals or time-release additives. Replace it only with a blank filter at the interval specified in your engine's operator's manual. Never use filters that contain supplemental coolant additives

(SCAs) in an ELC-filled system. Consult your engine operator's manual for information on the coolant filter and service procedures.



CAUTION

Use of non-genuine PACCAR coolant filters can cause severe engine damage.

Cooling System Sealing Additives and Soluble Oils

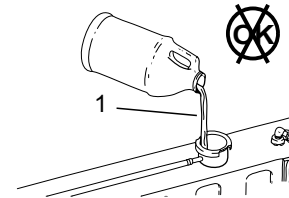

1. Do not use soluble oils or sealing additives.



CAUTION

The use of sealing additives or soluble oils in the cooling system can cause damage to the engine. These additives can plug various areas of the radiator, EGR system and oil cooler. The plugging of the cooling system can hamper heat transfer, causing internal engine damage. DO NOT use sealing additives or soluble oils in the cooling system. The use of sealing additives can

- Build up in coolant low-flow areas
- Plug the radiator and oil cooler
- Damage the water pump seal
- Damage heat transfer surfaces
- Damage seals and hoses
- Corrode brass and copper

Failure to comply may result in equipment or property damage.

Lubrication

Proper lubrication procedures are important for a good maintenance program. If the lubricant is not doing its job

or if the lubricant level is ignored, all other maintenance procedures are not going to keep the transmission running or assure long transmission life.

Lubricant changes should be based on a combination of the intervals shown in vehicle operator's manual, the Lubrication and Maintenance service manual, and user judgment – based on vehicle application and operating environment. Extending drain intervals beyond those shown in the tables is not recommended and will put warranties at risk.

To ensure that transmission internal parts are amply lubricated, do the following:

- Maintain lubricant level and inspect regularly.
- Follow maintenance intervals, see [Preventative Maintenance](#) on page 45.
- Use the correct grade and type of lubricant, see [Transmission Lube Specification](#) on page 62.
- Buy lubricant from an approved dealer.

Draining the Transmission

Draining lubricating fluid from the transmission should only be performed during fluid replacement or a repair. Take

your vehicle to a PACCAR Powertrain distributor for maintenance processes that require draining transmission lubricant.

See [Transmission Lubricant Capacities](#) on page 62 and [Transmission Lube Specification](#) on page 62 for more information on the amount and type of lubricant required for this transmission.

Checking Transmission Fluid Level

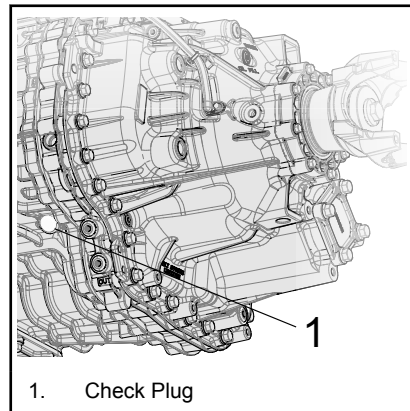

Required tools:

- Small container (to catch fluid)
- Standard wrench
- Torque Wrench
- 8mm hex bit socket

Perform this procedure with the transmission installed in the vehicle.



CAUTION

DO NOT operate the transmission at an operating angle greater than 12° (approximately 21% road grade). The operating angle is the transmission mounting angle plus the road grade expressed as an angle. Failure to comply will result in improper transmission lubrication and may result in equipment or property damage.

1. Park vehicle on a level surface with the transmission in neutral, engage the parking brake, and chock the tires.
2. Turn off the engine after it has idled for two minutes.¹⁰

3. Locate the check plug (1) and place container under the check plug hole.¹¹
4. Remove the check plug using wrench.
5. Observe the check plug hole:
 - a. If a small amount of fluid runs out of the check plug hole, there is sufficient transmission fluid.
 - b. IF NO fluid runs out of the check plug hole, STOP. Replace check plug and add fluid to the transmission (see [Adding Transmission Fluid](#) on page 55).
6. Inspect the check plug and O-ring for damage. If damaged, replace with new plug and O-ring.
7. Insert the check plug with O-ring, and torque plug to 37-43 N·m (27.3-31.7 lb-ft).



NOTE

Do not over-torque the check plug or transmission damage may occur.

Adding Transmission Fluid

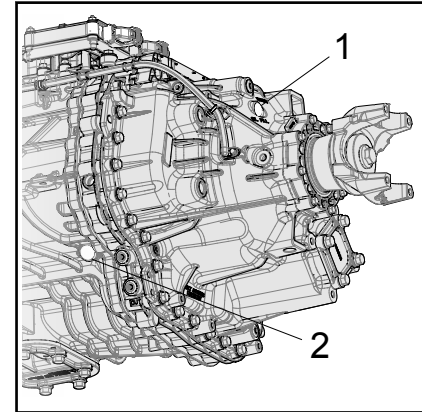

¹⁰ Idling the engine places oil temperature in the required range for this procedure: 60° F – 120° F (15.5° C – 48.8° C).

¹¹ Check plug can be accessed beneath the cab, driver side.

1. Fill Plug
2. Check Plug

Required tools:

- Small container (to catch fluid)
- Transmission fluid (See [Transmission Lube Specification](#) on page 62)
- Standard wrench
- Torque wrench
- 6mm hex bit socket
- 8mm hex bit socket
- Fluid lubricant pump with hose (optional)

Perform this procedure with the transmission installed in the vehicle.

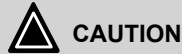

DO NOT operate the transmission at an operating angle greater than 12°

(approximately 21% road grade). The operating angle is the transmission mounting angle plus the road grade expressed as an angle. Failure to comply will result in improper transmission lubrication and may result in equipment or property damage.

1. Park vehicle on a level surface with the transmission in neutral, engage the parking brake, and chock the tires.
2. Turn off the engine after it has idled for two minutes.¹²
3. Remove fill plug (1) with wrench.¹³
4. Place a suitable container under the check plug hole.
5. Remove check plug (2) with wrench.¹⁴
6. Fill transmission at fill hole (1) until a small amount of fluid runs out of the check plug hole (2).¹⁵

7. Inspect fill plug and O-ring for damage. If damaged, replace with new plug and O-ring.
8. Insert fill plug with O-ring and torque plug to 24.5-29.5 N·m (18-22 lb-ft).



NOTE

Do not over-torque the fill plug or transmission damage may occur.

9. Inspect check plug and O-ring for damage. If damaged, replace with new plug and O-ring.
10. Insert check plug with O-ring and torque plug to 37-43 N·m (27.3-31.7 lb-ft).

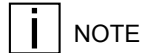

NOTE

Do not over-torque the check plug or transmission damage may occur.

¹² Idling the engine places oil temperature in the required range for this procedure: 60° F – 120° F (15.5° C – 48.8° C).

¹³ Fill plug can be accessed beneath the cab, driver side.

¹⁴ Check plug can be accessed beneath the cab, driver side.

¹⁵ Due to the fill hole location, use of a fluid lubricant pump is advised.

If equipped with a PTO or transmission cooler, start engine and run for 1 to 2 minutes to fill these components with transmission fluid. Afterwards, turn off the engine and recheck fluid level (see [Checking Transmission Fluid Level](#) on page 54).

Mixing of Oil Types

	CAUTION
Do not mix engine and gear oil in the same transmission. Mixing engine and gear oils could cause damage to the transmission.	

	CAUTION
DO NOT use additives or friction modifiers. Neither are approved for this transmission. Using an additive or friction modifier can break down both lubrication and transmission components, resulting in degraded performance and equipment damage, and may affect warranty coverage.	

Engine oils and gear oils may not be compatible; mixing can cause breakdown of the lubricant and affect component performance. When switching between types of lubricants, all areas of each affected component must be thoroughly flushed.

	NOTE
For a list of approved lubricants, see Transmission Lube Specification on page 62.	

Troubleshooting

Diagnostics

In the event there is a problem with this transmission, there are three primary tasks the driver should perform:

1. Note the driving condition under which the problem occurred.
2. Note the condition of the transmission under which the problem occurred (such as operation mode (Drive, Manual,

Low), current gear, and engine speed).

3. Reset system.

Transmission Reset Procedure

In some cases, proper transmission operation can be restored by “resetting” the Transmission Control Module (TCM). Use the following procedure to reset the TCM.

1. Continue to drive the vehicle to a safe location before selecting neutral (**N**).

	NOTE
Once neutral (N) is selected, a gear engagement may not be allowed depending on the specific problem.	

2. Place the transmission in neutral (**N**).
3. Set the vehicle parking brake.



WARNING

Apply parking brake and follow vehicle manufacturer parking instructions. Failure to follow these instructions could cause unintended vehicle movement resulting in death, serious injury or damage to property.

4. Turn the vehicle ignition switch to **OFF**.
5. Wait at least 2 minutes.
6. Restart the engine.
7. If the problem continues, contact a service facility to have the vehicle and transmission system evaluated.

Chapter 7 | SPECIFICATIONS

General Model Information.....	61
Calibration Options.....	61
Transmission Lubricant Capacities.....	62
Transmission Lube Specification.....	62
Frame Fastener Torque Requirements.....	63
Roadside Assistance.....	64

General Model Information

Transmission Identification Tag

All transmissions are identified by the model and serial number. This information is stamped on the transmission identification tag and affixed to the case.

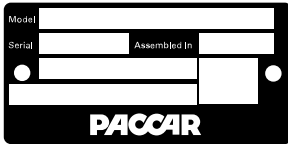

NOTE

Do not remove or destroy the transmission identification tag.

The blank spaces provided below are for recording transmission identification data. Have these reference numbers handy when ordering replacement parts or requesting service information:

Transmission
Model _____

Transmission Serial
Number _____

Nomenclature

Following is a nomenclature tree that describes the multiple configurations of the transmission model numbers:

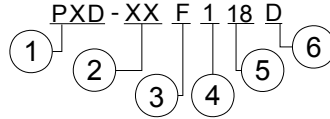

- 1 PXD = PACCAR TX-18
PXDP = PACCAR TX-18 PRO
- 2 Torque Capacity (XX × 100 +50 lb-ft)
- 3 Units for Torque [F = lb-ft; N = Nm]
- 4 Design Level
- 5 Forward Speeds
- 6 Gear Ratio Set
D = Double Over Drive

Calibration Options

This transmission's operating parameters can be calibrated for the intended vehicle application.

Some example calibrations are

- Standard – normal on-highway driving that blends performance and fuel economy.
- Performance – tuned to get the most performance from the engine at all vehicle weights.
- Tanker – fast shifts for unbuffered tankers do not disrupt the shifting load.



NOTE

A new calibration can be selected at a PACCAR Powertrain distributor. Not all calibration options are available with all engine/transmission model combinations.

Transmission Lubricant Capacities

The capacity listed on the transmission label plate is the amount needed to fill the transmission only and does not include the additional amount needed for hosing. The capacities listed here reflect the *approximate* total amount required to maintain transmission lubrication in the operating range. Always use the transmission check hole as a final reference.

Transmissions equipped with a dedicated cooler or Power Take-off (PTO) have larger capacities than those listed.

TX-18 Lubricant Capacity

Pints (US)	Liters
25.4 (≈ 3.2 gal)	12

Transmission Lube Specification



CAUTION

Only use lubricants approved for this transmission. Failure to use an approved lubricant can break down both lubrication and transmission components, resulting in degraded performance and equipment damage, and may affect warranty coverage.

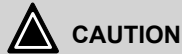

CAUTION

DO NOT use additives or friction modifiers. Neither are approved for this transmission. Using an additive or friction modifier can break down both lubrication and transmission components, resulting in degraded performance and equipment damage, and may affect warranty coverage.

PACCAR approves use of **PACCAR Genuine PS-386 (Eaton approved)**

synthetic transmission fluid to ensure the highest performing lubricants for maximum performance. All other approved rebrands for this lubricant are also acceptable.

PACCAR

GENUINE PARTS

Frame Fastener Torque Requirements



CAUTION

Incorrectly tightening the fasteners may result in failure of the fastener or incorrect clamp loads. Fastener failure may lead to frame failure. Failure to comply may result in equipment or property damage.

- Use a torque wrench for final tightening of these fasteners. Because of the coating on the threads of these bolts, be aware that if an impact gun is used to tighten the fasteners, they may over-torque and break.
- When torquing, the nut must rotate slightly before achieving the torque value. If the nut does not rotate, the fastener is over-torqued and should be replaced.
- To achieve correct clamp loads, the frame fasteners must be torqued with the nut. The intended clamp load may not be achieved

if the nut is held and torque is applied to the bolt.

Nylon lock-nuts (AKA, "ESNA" or "nyloc")

Standard Grade 8 UNF or UNC Nylon Lock-Nuts:

Standard Fastener Size [-in.] (with NYLON insert nuts)	Tightening Specification lb-ft (N•m)
5/16	16-22 (22-30)
3/8	30-40 (41-54)
7/16	55-65 (75-88)
1/2	80-90 (109-122)
9/16	115-140 (156-190)
5/8	165-195 (224-265)
3/4	290-340 (394-462)
7/8	380-460 (517-626)
1	700-830 (952-1,129)

Standard Fastener Size [-in.] (with NYLON insert nuts)	Tightening Specification lb-ft (N•m)
1-1/8	990-1,170 (1,346-1,591)
1-1/4	1,380-1,630 (1,877- 2,217)

Metric Fastener Size (with NYLON insert-nuts)	Tightening Specification lb-ft (N•m)
M5	6-9 (8-12)
M6	7-11 (9-15)
M8	17-23 (23-31)

General considerations when using Standard Grade 8 UNF or UNC Nylon Lock-Nuts:

- Use only lock-nut with nylon insert.
- Lubricate nylon insert nut lightly with SAE 20W or 30W oil.

- Tighten all frame fasteners with a torque wrench.

 **NOTE**

The torque values and instructions found in this section apply **ONLY** to Nylon locknuts (right image). They do **NOT** apply to the all-metal lock-nut type (left image).



 **NOTE**

The torque values are applicable to fasteners on the **FRAME** and **DO NOT APPLY** to u-bolts for the suspension.

Fasteners with all-metal lock-nuts

Metric Fastener Size (with all METAL Lock-nuts)	Tightening Specification lb-ft (N•m)
M10	29-41 (39.4-55.6)
M12	51-69 (69.1-93.5)
M16	125-165 (169.5-223.7)
M20	230-300 (311.8-406.8)

General considerations when using all-metal lock-nuts:

- Do not lubricate all-metal lock-nuts.
- Bolts and washers can be reused, but nuts can only be reused once. If reuse history is unknown, install new nuts.
- If a bolt must be replaced the nut installed on it must also be replaced.

- Fasteners must be torqued from the nut to achieve correct clamp load.

 **NOTE**

The previous table with torque values and the instructions in this section apply **ONLY** to all-metal lock nuts (left image) but do **NOT** apply to Nylon lock-nuts (right image).



Roadside Assistance

Open 24 hours a day, 365 days a year, call toll-free to talk to someone at the PACCAR Vehicle Support Center:

- Kenworth customers

**1-800-KW-Assist
(1-800-592-7747)**

- Peterbilt customers
**1-800-4Peterbilt
(1-800-473-8372)**

The PACCAR Vehicle Support Center

- Uses a custom mapping system that locates PACCAR Powertrain distributors and Independent Service Providers (ISPs) near you, listing services offered, hours of operation, and contact information.
- Assists with jump and pull starts, tires, trailers, fines and permits, chains, towing, hazardous clean-up, out of fuel (roadside), mechanical repairs and preventive maintenance services.
- Employs multilingual agents and has access to a translation service, ensuring quality assistance for customers in any language.
- Places you in contact with a PACCAR Powertrain distributor who can answer your warranty questions.
- Provides these services for FREE.

Index

A

Adding Transmission Fluid [55](#)
Additives to Cooling System [51](#)

Air System

Air Compressor [50](#)
Air Dryer Oil-coalescing Cartridge [51](#)
Transmission Air Supply [21](#), [51](#)

Auto-neutral [14](#)

Automatic Mode, See Manual and Automatic Modes

Auxiliary Transmission (option) [14](#)

Auxiliary Transmission Switch (option) [31](#)

C

Calibration Options [61](#)

Changing gears, See Column Shifter

Checking Transmission Fluid Level [54](#)

Clutch Abuse Protection [14](#)

Clutch Temperature Gauge [24](#)

Coast Mode [14](#)

Column Shifter

Engine Brake Operation [30](#)
Manual and Automatic Modes [30](#)
Transmission Modes [16](#), [17](#), [23](#), [27](#), [28](#)
Upshifting and Downshifting [29](#)

Cooling system maintenance [51](#)

Creep Mode [15](#)

Cruise Control [15](#)

D

Diagnostics [57](#)

Display Launch [21](#)

DNR Indicator [23](#)

E

Engine Brake

Indicator [23](#)

Operation [30](#), [38](#), [39](#)

Engine Cooling Recommendations and Specifications [51](#)

Engine Overspeed Protection [15](#)

Engine Underspeed Protection [15](#)

F

Final Chassis Bill of Material [10](#)

Frame Fastener Torque Requirements, Nyloc, ESNA, Lock-Nuts [63](#)

G

Gear Display [23](#)

General Safety Instructions [6](#)

H

High Clutch Temperature [24](#)

High-range Reverse [15](#)

Hill Start Aid

- Disable Switch [31](#)
- Downhill Facing [38](#)
- Forward Facing [38](#)
- Hill Start Aid [16](#), [24](#), [31](#), [37](#), [38](#)
- Hill Start Aid (HSA) Disabled Warning Light [24](#)
- Operation [37](#)

Hold Gear Mode [16](#)

I

Identification Tag [61](#)

Illustrations [6](#)

L

Limited Driveline-connected Towing [42](#)

Load-based Shifting [16](#)

Low Mode

- Low Mode [16](#), [38](#)
- Operation [30](#), [38](#), [39](#)

Low Transmission Air Actions [22](#)

Lubrication

- Adding Fluid [55](#)
- Capacity [62](#)
- Checking Level [54](#)
- Draining the Transmission [54](#)
- Mixing Oil Types [57](#)
- Specifications [62](#)

M

Maintenance Manuals [10](#)

Manual and Automatic Modes [30](#)

Manual Mode, *See* Manual and Automatic Modes

Manual Override [30](#)

MAX Mode

- Max Mode [17](#)
- Operation [30](#), [38](#), [39](#)

N

Neutral [27](#)

Neutral Coast Mode [17](#)

Nomenclature [61](#)

O

Optimized Gear Selection [17](#), [28](#)

P

Popups

What are Popups? [22](#)

Power Down [37](#)

Power Take-off (PTO)

Mobile Operation [39](#)

PTO Switch [31](#)

Stationary Operation [40](#)

Preventative Maintenance [45](#)

Preventative Maintenance Schedule

Annually [49](#)

Every 240,000 mi / 384,000 km / 3 yr [49](#)

Every 30,000 mi / 48,000 km [48](#)

Every 500,000 mi / 800,000 km / 5 yr [50](#)

Every 60,000 mi / 96,000 km / 6 mo [48](#)

Every 7,500 mi / 12,000 km [47](#)

Weekly Checks [47](#)

Proper Clutch Use [36](#)

R

Repairs [9](#)
Reverse [28](#)
Roadside Assistance [64](#)

S

Safety Alerts [5](#)
Shifter, *See* Column Shifter
Start Gears [35](#)
Start up [35](#)

T

Transmission Air Supply [21](#), [51](#)
Transmission Gear Display [23](#)

Transmission Modes

- DNR Indicator [23](#)
- Drive (automatic) [28](#)
- Low [16](#)
- MAX [17](#)
- Neutral [27](#)
- Reverse [28](#)

Transmission Oil Temperature Gauge [24](#)
Transmission Reset Procedure [57](#)
Transmission, Auxiliary [23](#)
Troubleshooting [57](#)

U

Upshifting and Downshifting [29](#)
Urge to Move [18](#)
Using High-range Reverse When Moving [29](#)
Using High-range Reverse When Stationary [28](#)
Using this Manual [5](#)

V

Vehicle Towing [41](#)

PACCAR^{inc}
Powertrain
P.O. Box 1518
Bellevue, WA 98009

Y53-1349-1A1