

# Dana Electrification Systems Supplementary Operator's Manual

Kenworth Model K270E/K370E

KWSG-0021

September 2022





# Roadside Assistance

Call toll-free to talk to someone at the PACCAR Customer Center.

**1-800-KW-Assist** (1-800-592-7747)

The Customer Call Center is open 24 hours per day, 365 days per year, and is staffed with trained personnel (English and other languages if necessary), free of charge, to provide total roadside assistance. Their custom mapping system can locate the nearest Authorized Dealers and Independent Service Providers (ISPs) based on the vehicle's location. In addition, the customer center can dispatch services for tires, trailers, fines and permits, chains, towing, hazardous clean-up, mechanical repairs, and preventive maintenance services. If they cannot answer a specific question, they will direct you to a representative who can.

# First Responder's Guide

First Responder instructions are available through the QR code or URL below. Download and print the documentation for the Kenworth K270E/K370E with your current model year. Routinely check the NFPA site to ensure your first responder materials are up to date.



*QR Code for First Responder Instructions*

*(Scan with phone camera or use URL below)*

<https://www.nfpa.org/Training-and-Events/By-topic/Alternative-Fuel-Vehicle-Safety-Training/Emergency-Response-Guides/Kenworth>

# Contents

Introduction	4
Electric Powertrain	4
Telematics	6
Chapter 1 - Safety	7
Safety Alerts and Warnings	
Warnings and Safety Regulations	
Modification of the Vehicle	
Cooling System Fill Cap	
Oils and Lubricants	
Maintenance Activities	
Environment	
High Voltage (HV) System	
Low Voltage (LV) System	
Welding	
Jump-Starting	
Towing	
Chapter 2 - Emergency	15
Emergency Operation	
Safety Procedures for a Damaged HV Battery Pack or Nearby Fire	
Fire Instructions	
Vehicle Recovery without HV Battery Pack Damage	
Chapter 3 - Truck Operation	17
Vehicle Display and Instruments	
Electrification Display	
Chapter 4 - Quick Start Guide	24
Charging the High Voltage (HV) Battery Pack	
Driving the Vehicle	
Cabin Heating	
Chapter 5 - Maintenance	28
Normal EV Powertrain Maintenance	
Normal Vehicle Chassis Maintenance	
Long Term Storage	

# Introduction

This vehicle is equipped with a 100% electric powertrain that was manufactured and installed by Dana. It is important to understand the operational characteristics and functions of this electric vehicle (EV). The supplemental manual provides information that is not part of the base OEM chassis. Please refer to the OEM operator's manual for information unrelated to the EV functions.

## Electric Powertrain

The Dana Electric Powertrain is a 100% electric drive and does not use an internal combustion engine. Some of the vehicle's systems operate differently and have different operating characteristics than vehicles equipped with an internal combustion engine. Read this manual thoroughly before you drive the electrified vehicle to ensure the operating and safety requirements are understood.

As the vehicle operates, the high voltage (HV) battery pack gradually discharges. If the HV battery pack is completely discharged, the vehicle will not operate until it is recharged.



**Warning:** Do not allow the HV battery pack to discharge below specified limits. Failure to comply may cause equipment damage.

This vehicle uses a low voltage (LV) lead acid battery pack and an HV lithium-ion battery pack. The LV battery pack uses two 12V lead acid batteries for startup of both 12V and 24V components. Similar to internal combustion engine powertrains, the HV DC-DC converter uses energy from the HV battery to power auxiliary components such as the audio system, supplemental restraint system, headlights, power steering, and windshield wipers.

The HV battery pack provides power to the propulsion motor that moves the vehicle. The HV battery pack also charges the LV battery pack and powers LV components through the DC-DC converter. The vehicle must be plugged in to recharge the HV battery pack. Additionally, the vehicle system can extend the vehicle range through regenerative braking. Regenerative braking converts braking power into electricity that is stored in the HV battery pack while the vehicle is decelerating or driven downhill.



**Warning:** Your vehicle contains a sealed lithium-ion HV battery. If the lithium-ion battery is disposed of improperly, there is a risk of severe burns and electric shock that may result in serious injury or death. There is also a risk of environmental damage.



**Caution:** To prevent damage to the lithium-ion battery:

- Do not use the lithium-ion battery for any other purpose.
- Do not leave the vehicle in a zero or near zero state of charge for more than 14 days. Check the lithium-ion battery available charge gauge display prior to parking the vehicle for extended periods of time.
- Do not expose the vehicle to extreme ambient temperatures for extended periods (see Long-term Storage).
- When storing the vehicle, follow the Long-term Storage requirements as defined in this manual (see Long-term Storage).

Failure to comply with these instructions may cause equipment damage.

The capacity of the HV battery pack to hold a charge will decrease with time and usage. As the battery pack ages and capacity decreases, the driving range will decrease. This is normal,

expected, and not indicative of any defect in your HV battery. Testing has indicated that battery capacity will be up to 80% of original capacity after six years. This is only an estimate, and this percentage may vary significantly depending on individual vehicle and HV battery pack usage. The HV battery pack has limited-service life.

The image below identifies each major component of the electrification system. Your truck will have either a forward charging inlet or a rear charging inlet.

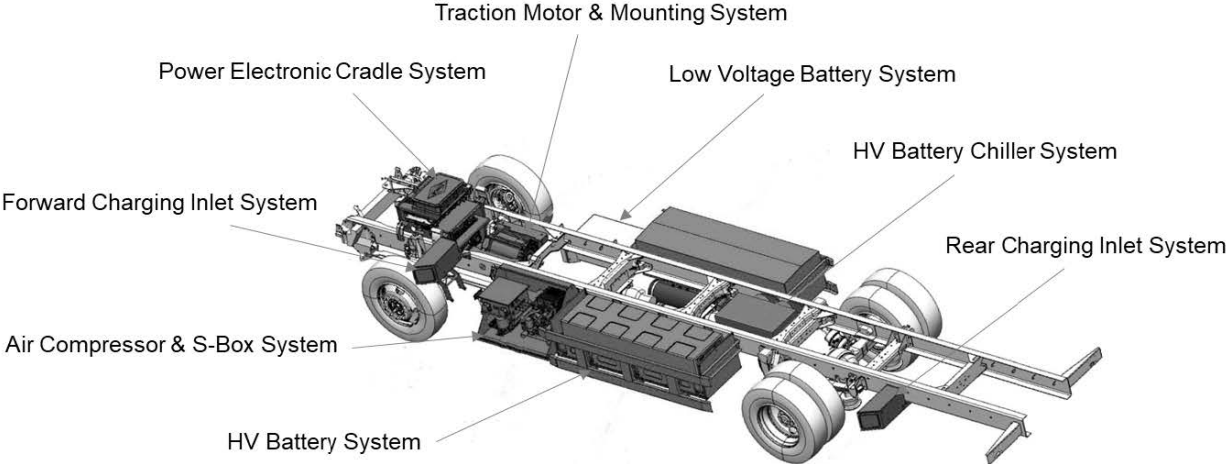

# TELEMATICS

This vehicle is equipped with electronic modules that monitor and record data for several vehicle systems, including the traction motor, battery packs, braking, and other electrical systems. Other electronic modules record information concerning driving conditions, including parking operation, braking, acceleration, trip distance, and other related information about your use of the vehicle. Features such as air conditioner or headlight usage, diagnostic trouble codes, vehicle charging, vehicle speed, direction, and/or location are also recorded to provide feedback depending on the vehicle driving state.

Some data is stored by the vehicle for vehicle servicing. Other data concerning your vehicle's operation and performance is wirelessly transmitted through the vehicle onboard telematics system upon vehicle start-up or at other intervals to Dana. This data may be used by Dana for various purposes, including EV services troubleshooting; vehicle quality, functionality, and performance; analysis and research by Dana designed to, among other things, optimize performance of future electric vehicles including improvements in future battery life; and as otherwise may be required by law. Such data may be shared with Dana's parents, subsidiaries, affiliates, successors or assignees, authorized PACCAR certified DEP dealers, PACCAR's marketing partners, your fleet company (if your vehicle is a fleet vehicle), your rental company (if your vehicle is a rental vehicle), and third-party service providers such as cellular information systems and data management providers.

Telematics features are dependent on cellular data transmission. Some areas may have limited or no cellular connectivity, resulting in a loss or interruption of data transmission. As a result, certain features may be temporarily unavailable. Even in areas with good reception, cellular connectivity can be adversely affected by tall buildings, apartments, tunnels, underground parking, mountains, etc. Even if the signal strength bar of the in-vehicle data communication module indicates good reception, connectivity may be disrupted. This does not indicate a malfunction. Operate the system again after a few minutes to restore connectivity.

# Chapter 1 - Safety

## Safety Alerts and Warnings

### SAFETY ALERTS

Please read and follow all safety alerts in this manual. They are for your protection and information. The alerts can also help you avoid injury to yourself and your passengers. The alerts can also help prevent costly damage to the vehicle. Safety alerts are highlighted by safety alert symbols and signal words such as "Warning", "Caution", or "Note." Do not ignore any of these alerts.

#### Warning



The safety message following this symbol and word provides a warning against operating procedures that could cause serious injury or even death. Failure to follow these warnings could also cause equipment or property damage. The alert will identify a hazard, how to avoid it, and the probable consequence of not avoiding the hazard.

#### Caution



The safety alert following this symbol and word provides a caution against operating procedures that could cause equipment or property damage. The alert will identify a hazard, how to avoid it, and the probable consequence if ignored.

#### Note



The alert following this symbol and word provides important information that is not safety related but should be followed. The alert will highlight things that may not be obvious but are useful to your efficient operation of the vehicle.

## Warnings and Safety Regulations



**Warning:** The following warning and safety regulations must be strictly observed for your safety, for bystanders' safety, and to prevent vehicle damage.

Read the instructions and warnings on the labels on all components. Failure to follow these warnings could cause equipment damage, property damage, injury, and death. The instructions and warnings are for your health and safety.



## Modification of the Vehicle

Modifying your vehicle could make it unsafe. Some modifications could affect your vehicle's electrical system, stability, or other important functions. The electric powertrain should not be modified for any reason. Modification to any of Dana's components will void your warranty. Modifications to the electric chassis could cause death or personal injury.



**Warning:** Connecting to an unapproved CAN (Controller Area Network) bus may trigger CAN fault codes. The manufacturer will not warrant failures or damage caused to the CAN bus components or vehicle if the failure or damage is caused by improper connections to the CAN bus or improper messages. Failure to comply may result in equipment damage.

## Cooling System Fill Cap



**Warning:** Do not remove the radiator fill cap while the powertrain is hot. Scalding steam and fluid under pressure may escape. You could be badly burned. Failure to comply may result in death or personal injury.

## Oils and Lubricants

Various kinds of oil and other lubricants used on the vehicle may constitute a health hazard if they contact the skin. This also applies to electric powertrain coolant, refrigerant in air conditioning systems, and battery acid. Do not contact vehicle liquids without the appropriate personal protective equipment.



**Warning:** Use only an authorized refrigerant lubricant for this vehicle. This vehicle uses a non-conductive refrigerant lubricant and not the typical refrigerant lubricant used for PACCAR vehicles. Use of a conductive lubricant could result in electrical damage within the compressor, possibly leading to a fire. Failure to comply may result in death, personal injury, equipment, or property damage.

## Maintenance Activities

When carrying out maintenance work under the cab, make sure the cab is fully tilted and locked to prevent it from falling back accidentally.

Following a collision, only tilt the cab in an emergency. The tilting mechanism may be damaged and a HV hazard might exist. (The end stop may no longer be on the lifting cylinder.)



**Warning:** Always support the vehicle with appropriate safety stands if it is necessary to work underneath the vehicle. A jack is not adequate for this purpose.

## Environment

Pollution is a serious threat to the environment. To keep pollution to a minimum, follow the below rules:

- Do not dump used oil, lubricants, hydraulic fluid, or coolants in drains, sewers, landfills, or on the ground. This is illegal. Return these fluids to the designated authority or appropriate chemical waste collection company for recycling or destruction. All used fluids must be stored separately.
- Service the vehicle regularly according to the instructions and recommendations in this manual. If component service intervals are not provided in this manual, check the truck manufacturer's operator's manual.

## High Voltage (HV) System



**Warning:** Repair of HV components or the HV battery is very dangerous and could cause severe burns and electric shock. Never remove or disassemble any HV components in this vehicle. All inspections and repairs must be conducted by an authorized and trained service dealer. Failure to comply may result in death or personal injury.



**Warning:** Do not touch or attempt to remove any orange colored HV cables, connectors, or components. Failure to comply may result in death or personal injury.



**Warning:** The HV system on this vehicle has no parts that an owner or unauthorized service technician can service. Under no circumstances should you open or tamper with the battery or other HV components. Always contact a certified service dealer. Failure to comply may result in death or personal injury.



**Caution:** The HV battery pack requires no routine owner maintenance. If the battery service icon illuminates, contact a PACCAR Dealership. Failure to comply may result in equipment damage or property damage.



**Note:** In the unlikely event of a fire, immediately contact your local fire emergency responders.



**Note:** The HV system on this vehicle does not have components that require service by the user. Do not disassemble, remove, or replace HV components, cables, or connectors. All HV cables are colored orange for easy identification.



**Note:** If a collision occurs, remove the keys from the ignition (if they are safely accessible) and do not touch any HV cables, connectors, or components.

## Low Voltage (LV) System

The cab system of this vehicle operates on 24V while other areas operate on 12V. When replacing or fitting electrical or electronic components, always verify that they are suitable for the system voltage.

### *LV Batteries*



**Warning:** Always disconnect the battery negative (ground) lead before carrying out repairs or service on the electrical system. Failure to comply may result in death, personal injury, equipment, or property damage.



**Warning:** Before attempting any work on the batteries or electrical system, remove all jewelry. If metal jewelry or other metal contacts with electrical circuits, a short circuit may occur, causing personal injury and causing electrical system failure and damage.

## Welding



**Warning:** Prior to welding on the electric vehicle, always perform the high voltage (HV) shutdown procedure. The HV shutdown procedure is not included in this manual and should only be performed by trained and certified personnel. Failure to comply may result in death, personal injury, equipment, or property damage.



**Warning:** The HV system on this vehicle has no parts that an owner or unauthorized service technician can service. Under no circumstances should you attempt to perform any part of this procedure. This procedure should only be performed by a trained and certified service provider. Failure to comply may result in death or personal injury.



**Caution:** Frame rails are heat-treated and should not be welded. Electrical components nearby welding could also be damaged. Dana's warranty does not cover damage to components caused by any type of welding.

## Jump-Starting Introduction

Jump-starting this vehicle is not a recommended practice due to requiring a 24V source voltage to perform the jump, and the various LV battery installations and electrical options that might be equipped.

### *LV Charging Reminders*

- Use protective eyewear.
- Keep all batteries away from children.
- Never reverse LV battery poles.
- Never attempt to place the vehicle in motion with LV batteries disconnected.
- Keep the LV battery clean and dry.
- Look for any signs of damage. Replace damaged 12V batteries according to the battery manufacturer's guidelines.
- Do not coat LV battery terminals with an improper grease. Use petroleum jelly or commercially available, noncorrosive, nonconducting terminal coatings.



**Warning:** DO NOT attempt to jump or charge a frozen LV battery. Jumping or charging a frozen battery can lead to an explosion. During extreme cold or following extended idle times in freezing temperatures, batteries can freeze. Thaw a frozen LV battery at room temperature before jumping or charging. Failure to comply can result in death, personal injury, component, or property damage.



**Warning:** Charger cables must be connected positive to positive (+ to +) and negative to negative (- to -). If connected improperly, LV batteries could explode. Failure to comply may result in personal injury, death, equipment, or property damage.



**Warning:** Always ensure the LV battery charger is OFF before connecting or disconnecting the cable clamps. To reduce the danger of explosions and resulting death or personal injury, do not connect or disconnect charger cables while the charger is operating. Failure to comply may result in death, personal injury,

equipment, or property damage.



**Warning:** Never use a fast charger as a booster to start the system. This can seriously damage sensitive electronic components such as relays, radio, as well as the LV battery charger. Fast charging a LV battery is dangerous and should only be attempted by a competent mechanic with the proper equipment.



**Warning:** LV batteries contain acid that can burn and gasses that can explode. Ignoring safety procedures may result in death, personal injury, equipment, or property damage.



**Warning:** Never jump-start a LV battery near fire, flames, or electrical sparks. LV batteries generate explosive gases that could explode. Keep sparks, flame, and lighted cigarettes away from LV batteries. Failure to comply may result in death, personal injury, equipment, or property damage.



**Warning:** When jump-starting with a booster LV battery, it is best to jump-start with an equivalently powered vehicle. Verify that the booster vehicle's LV battery has the same volt and CCA specifications as the dead LV battery before attempting to jump-start. Failure to comply may cause an explosion resulting in death, personal injury, equipment, or property damage.



**Warning:** When connecting and disconnecting jumper cables, ensure they are not caught on any moving parts under the hood. Failure to comply may result in death, personal injury, equipment, or property damage.



**Warning:** Heed all warnings and instructions from the jumper cable manufacturer. Failure to comply may result in death, personal injury, or property damage.



**Caution:** Using higher voltage booster for the LV batteries will cause expensive damage to sensitive electronic components such as relays, sensors, and control units. Always charge the LV batteries at the proper voltage. Improper use of jumper cables or not following these procedures can damage the electrical system or cause serious damage to both vehicles.



**Caution:** Do not modify or improperly repair the vehicle's electrical system or electric powertrain. All electrical repairs should be performed by an authorized dealer. Improper repair or modifications will void your warranty and/or cause serious damage to your vehicle.



**Note:** Review the warranty policy before performing any maintenance procedures. An extended warranty may be voided if unauthorized maintenance is performed during this period.

## Jump-Starting Instructions



**Caution:** Use only a 24V charging source when jump starting the Low Voltage (LV) Battery. Using a traditional 12V source, or any source less than 24V, will not successfully charge the LV Battery. Failure to comply may negatively impact the LV battery.

To jump-start your EV system with a booster battery, the instructions and precautions below must be followed. Jump-starting provides power to the Low Voltage (LV) system for the electrical systems to operate. The electrical systems must be operating to allow the HV battery pack to be charged. Jump-starting does not charge the HV battery pack. The HV battery pack must be charged before the vehicle can be driven.

The LV battery is in the LV battery box, located on the passenger-side, back of cab. Ensure that the 24V battery disconnect switch (located forward of the LV battery box) is in the connected position and all LV cables are secure before attempting to jump-start the vehicle.

## ***Preparing the Vehicles***

1. Remove any jewelry that may contact the battery terminals (refer to the Kenworth vehicle operator's manual for additional safety precautions).
2. Select a jumper cable that is long enough to attach to both vehicles in a way that ensures neither vehicle touches each other.
3. Position the two vehicles together, but do not allow them to touch.
4. Turn off all lights, heater, radio, and any other accessory on both vehicles.
5. Set the parking brakes by pulling the park brake knob back. The park brake knob is located behind the push button shifter.
6. Ensure the vehicle with the Dana electric powertrain has the 24V battery disconnect in the **OFF** position, if optional.<sup>1</sup> If the other vehicle has a battery disconnect, ensure it is also in the **OFF** position prior to connecting the two vehicles.

## ***Connect the LV Batteries***

7. Locate the battery in the series whose positive (+) terminal **is not** connected to another battery.



**Warning:** Attach jumper cables to terminals **not connected** to another battery.

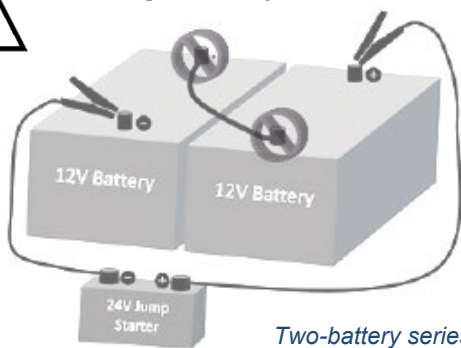

Battery positions and how they are connected can vary between vehicles. Pay close attention to which terminals you use to jump the battery. Failure to comply may result in overheating of the battery or cables, resulting in personal injury or damage to the batteries and the vehicle electrical system.

8. Attach one end of a jumper cable to the positive (+) terminal of the discharged (dead) battery. This will have a large red + or P on the battery case, post, or clamp.
9. Attach the other end of the same cable to the positive (+) terminal of the good (booster) battery.
10. Attach the remaining jumper cable **FIRST** to the negative (-) terminal (black or N) of the good battery.

<sup>1</sup> When optional, the 24V battery disconnect is located forward of the LV battery box.

11. Attach the other end of the negative cable to the negative (-) terminal (black or N) of the discharged (dead) battery.



**Warning:** Always connect the battery terminals from positive (+) to positive (+) and from negative (-) to negative (-). Failure to comply may result in personal injury, death, equipment, or property damage.

12. If either vehicle is equipped with battery disconnects, ensure that they are both in the **ON** position.
13. Start the vehicle that has the good battery first and run the vehicle for 5 minutes.
14. Start the vehicle that has the discharged (dead) battery. If you do not get a **READY** indication, contact the nearest authorized dealer.

## Removing Jumper Cables

15. Perform steps 8 through 11 in reverse. Ensure the negative cable is removed from the vehicle with the discharged battery first. During these steps, keep the vehicles running.

## Towing Instructions

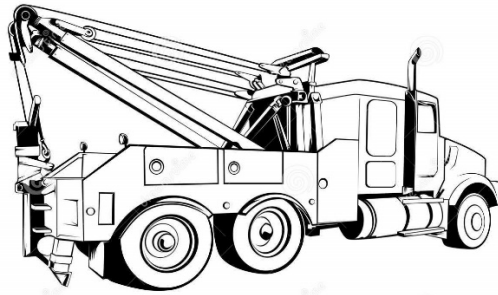

**Warning:** Shut down the HV system before towing electric commercial vehicles for ANY distance. HV Shutdown should never be performed by anyone that has not been trained and certified. Failure to comply may result in personal injury, death, equipment, or property damage.



**Warning:** After an accident, follow the first responder's manual special instructions for towing. Failure to comply may result in personal injury, death, equipment, or property damage.



**Warning:** Both axle shafts must be removed from the drive axle housing to ensure the propulsion motor will not rotate during the towing process. Otherwise, it may generate unsafe voltage even with the HV bus shutdown.



**Note:** Only follow the shutdown procedures found in Dana's manuals for this electric chassis.

## Towing Procedure

1. Remove the key from the ignition and turn the 24V battery disconnect to the **OFF** position, then wait for 2 minutes.
2. Block the front and back of at least one of the vehicles tires so the truck cannot move during this procedure.
3. Starting on the driver's side, place a drip pan under the end of the drive axle wheel hub to catch the lube.
4. With an impact gun, remove the axle shaft nuts, washers, and tapered dowels if used.
5. Remove the axle shaft from the drive axle housing.



**Note:** Do not use a chisel or any other wedge device to loosen the shaft. Chisels and wedges will damage the flange of the wheel hub.

6. Wipe the end of the wheel hub to remove any oil.
7. Install a wheel end cover over the axle shaft studs.
8. Reinstall the wheel end fasteners and tighten in a crisscross pattern. Do not over tighten.
9. Repeat steps 2-7 on the passenger's side of the drive axle.

# Chapter 2 - Emergency

## Emergency Operation



**Warning:** HV Shutdown should only be performed by someone who is both trained and certified. Failure to comply may result in personal injury, death, equipment, or property damage.



**Warning:** Because EV's can move with little or no sound, conventional methods of determining if a vehicle can be moved under its own power cannot be relied upon. Making assumptions that the vehicle is not powered up can be dangerous. Failure to comply may result in personal injury, death, equipment, or property damage.



**Warning:** Always be prepared to deal with hazardous conditions when working with EV's by wearing the proper safety equipment. Failure to comply could result in personal injury or death.



**Note:** Shut down procedures will vary between OEM's and even vehicle models.



**Note:** Proper techniques and standard protocols are essential for safety during an emergency operation involving an electric vehicle (EV).

## Safety Procedures for HV Battery Pack Damage or Nearby Fire

1. Contact firefighters.
2. Provide firefighters a copy of the first responders field guide and direct them to the first responders label under the hood (see image below). Create a safety perimeter of at least 6 feet around the vehicle.
3. Move to an area upwind and far enough away from the accident site to avoid breathing any hazardous smoke or gases.



**Warning:** Do not enter the vehicle or touch the chassis until receiving approval from first responders. Failure to comply could result in personal injury or death.



**Note:** Always assume that the HV battery packs could be damaged after an accident and have it inspected by a service technician



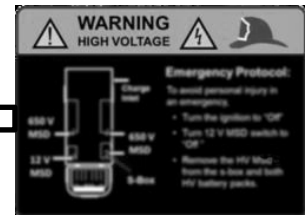
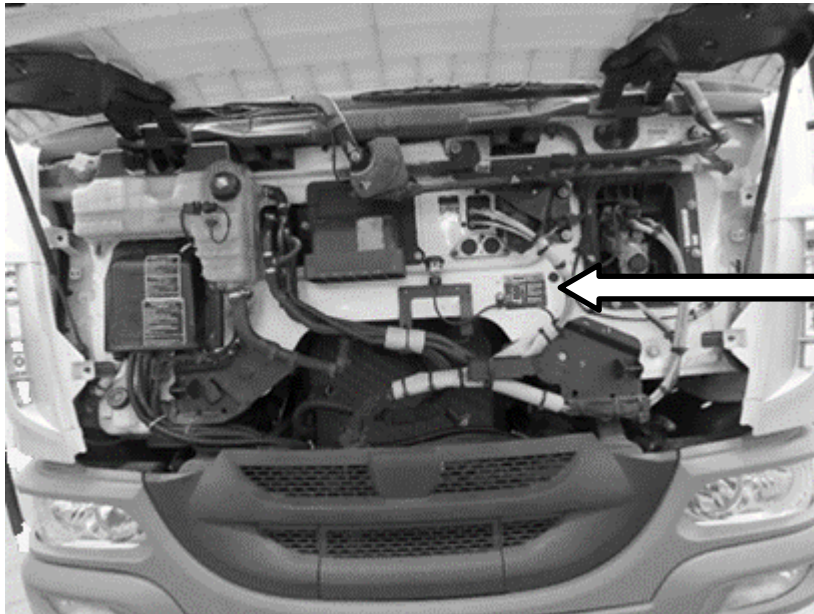

First Responders Label Location

## Fire Instructions:

During a fire, certain plastic seals may produce gases that can form a corrosive acid if combined with water. Do not touch any fluid on the vehicle.

1. Exit the vehicle.



**Note:** Do not attempt to put out a battery pack fire with a fire extinguisher.

2. Create a safety perimeter of at least 6 feet around the vehicle.
3. Contact First Responders

## Turn-On Procedure without HV Battery Pack Damage (including the enclosure):

1. Turn the 24V battery disconnect switch back to ON (if optioned).
2. Turn the key to the START position.

# Chapter 3 - Truck Operation

## Vehicle Display and Instruments

This vehicle is equipped with a PACCAR instrument cluster behind the steering wheel and a battery electric truck display to the right of the steering wheel. The new telltale and gauge locations (relative to the previous diesel cluster) are noted below.

### Overheat Warning Light



**Warning:** If a coolant temperature warning shows an overheat condition, or you have any other reason to suspect the EV powertrain may be overheating, take immediate action as explained in "When the Coolant Overheats." Continued operation, even for a short time, may result in a fire, risk of personal injury, or severe vehicle damage.

#### *When the Coolant Overheats*

1. Turn on the hazard-warning flasher, immediately pull over to a safe place that does not impede traffic and place the truck in park.
2. Turn off the vehicle and contact the PACCAR Customer Center for direction: **1-800-KW-Assist** (1-800-592-7747).

### Stop Telltale



Instrument Check: Yes  
Location: Cluster  
Color: Red

Pull over as soon as possible when the "STOP Sign" telltale on the cluster is activated. Permanent damage to the truck or personal injury could occur with continued driving. After pulling over, call the PACCAR Customer Center: **1-800-KW-Assist** (1-800-592-7747).

### Service Vehicle Soon Telltale



Instrument Check: Yes  
Location: Cluster  
Color: Yellow

The Service telltale will activate when the vehicle needs to be serviced soon.

## High Voltage Hazard Telltale



Instrument Check: Yes

Location: Electrification Display

Color: Red

This telltale appears with a popup message when HV components are not functioning as required. Pull over as soon as possible when this telltale on the digital display is activated. Permanent damage to the truck or personal injury could occur with continued driving. After pulling over, call Dana's Real Time Warranty Group.<sup>2</sup>



**Warning:** If "Insulation Fault," "HVIL Fault," or other High Voltage System Faults appear on the Dana display, follow the below instructions. Personal injury, death, or permanent truck damage could occur if the below instructions are not followed.

### ***High Voltage Hazard Procedure:***

1. Pull over as soon as possible.
2. Remove the keys from the ignition.
3. Exit the truck.
4. Call the PACCAR Customer Center for guidance: **1-800-KW-Assist** (1-800-592-7747).

## Regenerative Braking Retarder Telltale



Instrument Check: Yes

Location: Cluster

Color: Green

The regenerative braking retarder telltale will activate after every key cycle or when the retarder ON switch located on the steering wheel is pressed. When the telltale is activated, regenerative braking is enabled. Regenerative braking automatically turns on after every key cycle.



**Warning:** Drivers should disable regenerative braking under low traction road conditions (e.g., ice, rain). Failure to comply may result in personal injury, death, equipment, or property damage.

---

<sup>2</sup> Dial 1-877-777-5360 and then Choose option 3 for Dana's RTW warranty. Agents are available 8:00AM to 5:00 PM EST. Prior to calling, please be prepared to provide the agent with detailed information pertaining to the failure and vehicle.

## Charging Telltale



Instrument Check: Yes  
Location: Cluster  
Color: Green

This telltale illuminates if the key is placed in the ignition when the truck is charging. Vehicle safety functions prevent the truck from being driven when the charger cable is connected.

## Limited Performance Mode Telltale



Instrument Check: Yes  
Location: Cluster  
Color: Yellow

The limited performance mode telltale will illuminate when severe derating is occurring on the powertrain. Refer to electric truck display for more information when events such as this occur. If the STOP telltale is not activated, it is possible to continue driving the truck, but the truck's acceleration and deceleration capabilities will be very limited.

## Regenerative Braking System Telltale



Instrument Check: Yes  
Location: Cluster  
Color: Yellow

RBS stands for "Regenerative Braking System." This telltale illuminates when the regenerative braking system is active and is severely derated or disabled. This can occur when the battery State of Charge (SOC) achieves or exceeds 95%, or due to abnormal operating conditions -- such as extreme ambient temperatures or long downhill grades.

When the RBS telltale is lit, the operator **must** rely on the service brakes. If neither the Service Telltale nor the Stop Telltale are activated, the truck may be driven while the RBS telltale is activated.



**Warning:** If the Regenerative Braking System (RBS) telltale appears, regenerative braking **cannot** be used to slow the vehicle. The vehicle can only be slowed using the service brakes. The RBS telltale appears when

- The battery State of Charge (SOC) is or exceeds 95%
- Operating in extreme temperatures

- Operating on long downhill grades

Failure to comply may result in personal injury, death, equipment, or property damage.

## DC-DC Converter Telltale



Instrument Check: No  
Location: Cluster  
Color: Yellow

The DC-DC converter is similar to an alternator since it supplies LV power to the truck. This telltale illuminates when the DC-DC converter malfunctions, and LV components could be impacted.

## PTO Enabled Telltale



Instrument Check: Yes  
Location: Cluster  
Color: Yellow

The PTO telltale will illuminate if you have an electric PTO on your truck and it is enabled.

## Low Charge Level Telltale



Instrument Check: Yes  
Location: Cluster  
Color: Yellow

The Low Charge Level telltale is located in the charge level gauge. This telltale will have a yellow illumination when the truck is close to entering Limited Performance Mode and needs to be recharged. When the charge level is within normal operating bounds, this telltale will have white backlighting.

## Charge Level Gauge

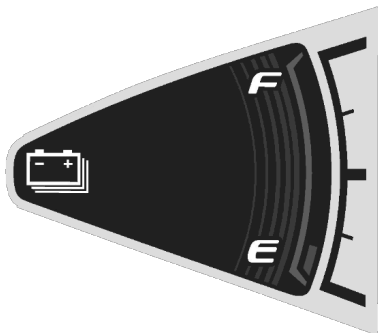

Location: Cluster

The Charge Level gauge shows the HV battery pack's state of charge from 0% (Empty) to 100% (Full) useable energy. When the state of charge is low, the battery telltale on this gauge will have orange illumination.

## Power Output Gauge



Location: Cluster

The Power Output gauge shows the power output from the HV battery pack. This includes auxiliary components (e.g., cab climate control, powertrain fan, HV battery heater, HV battery chiller, lights, etc.).

### Gauge Values

**OFF:** When the truck is not ready to drive, the gauge's needle will stay at OFF.

**READY:** When the truck has started up and ready to move, the needle will initially move to READY.

**CHARGE** (green region): During regenerative braking events, the needle will hover in the green CHARGE region. As regen braking power increases, the needle will move further counterclockwise into the green CHARGE region.

**POWER** (blue region): While the truck is ready to move but staying at 0 mph, the auxiliary component operation will keep the needle in the blue POWER region. While driving, especially during acceleration events, the needle will move further clockwise into the blue region.

## Electrification Display

Three System State Modes (Vehicle state is always display in the top right of the display)

**OFF** – 12V ACC is present, but HV is off.



**READY** – The HV bus is ON, and the truck is fully operational.



**Warning:** Do not assume the vehicle is off if the vehicle is silent! Failure to comply may result in personal injury, death, equipment, or property damage.



**Warning:** Remain watchful for pedestrians. This vehicle is much quieter than diesel powered models and a pedestrian may not be aware the vehicle is approaching. Failure to comply may result in personal injury or death.

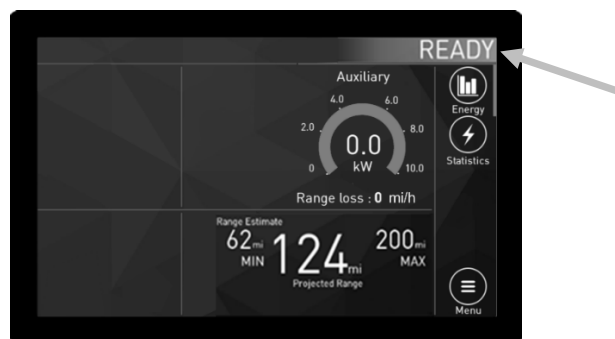



**CHARGE** – The HV bus is ON, and charge connector is plugged into the vehicle’s inlet.



**Auxiliary Power** – The auxiliary power gauge monitors usage of other chassis components. The truck range loss due to auxiliary power usage is shown in miles per hour of truck operation.

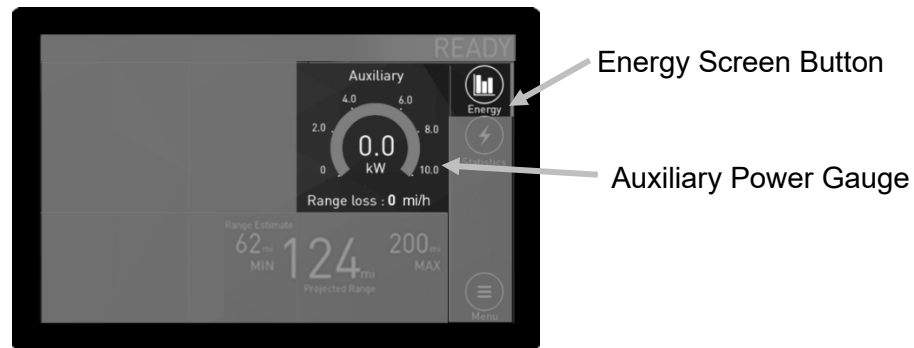

# Chapter 4 - Quick Start Guide

## Charging the High Voltage Battery Pack



**Warning:** Never spray liquid at high pressure towards the charging port while charging. Failure to follow these instructions can result in serious personal injury or damage to the vehicle, charging equipment, or property.



**Caution:** Do not store the battery pack above 104 °F (40 °C) for extended time periods. Permanent HV battery damage will occur (see Long-term Storage Requirements on page 33).



**Caution:** Use a compatible charger when charging the HV battery. Using different types of chargers that are not listed by Dana as compatible may have serious effect on the vehicle's durability. Failure to comply may result in equipment damage.



**Note:** After receiving the truck, customers must ensure that its first charge reaches 100% for cell balancing and state of charge reset. Nothing less than 100% (such as 99%) will allow the HV battery pack to perform these steps. Failure to fully charge the HV battery pack to 100% could result in poor range.



**Note:** During extreme hot or cold ambient conditions, keep the truck plugged in after charging is complete. This will enable the HV battery pack temperature management systems to help keep the battery packs in their optimal operating temperatures for quick startup and to prevent damage from extreme cold for long time periods.

### Maximum charge rate by battery

Battery Capacity (KWh)	Charge Rate (KW)
141	70.5
209	104.5
282	141



**Note:** The vehicle can only be charged when the key has been removed from the ignition switch. Additionally, the vehicle cannot be started if it is currently being charged.



**Note:** Allow the battery to fully charge to 100% SOC once a month. Depending on battery condition, the self-maintenance cycle may take 24 hrs.

## Charging Procedure

1. Turn off the vehicle and remove the ignition key.<sup>3</sup>
2. Open the charging port cover, and the charge port LEDs will illuminate WHITE.
3. Connect charging connector to the charge port.
4. A single 'chirp' will be heard, inside the cabin.
5. The system will run a self-check and activate.
6. A double 'chirp' will be heard, the electrification display will show READY, and the charge-port LEDs will turn GREEN.
7. When the charge port LEDs begin flashing GREEN, the vehicle is charging.

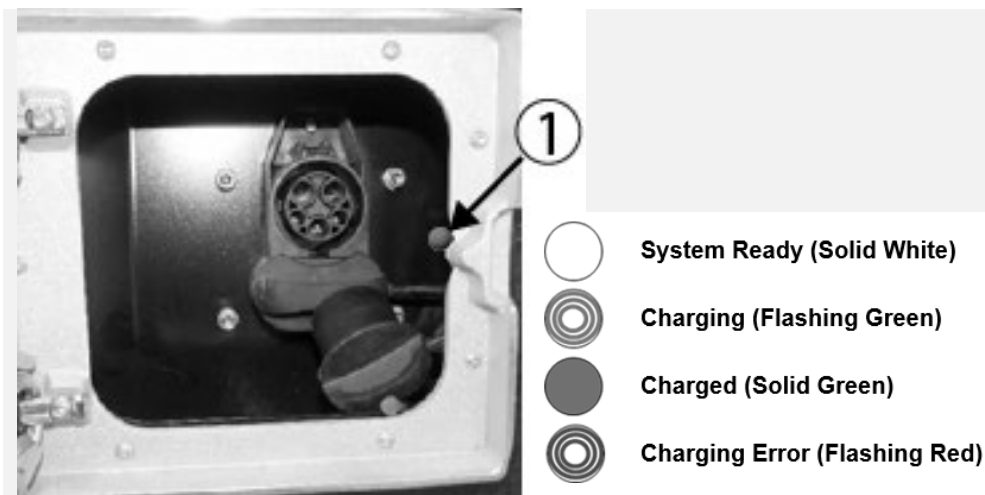

1. Charging State LED

8. A flashing red light indicates a charging error.
9. A steady green light means the charge is complete.

When the battery achieves 95% State of Charge (SOC) charge rate is reduced (between 14KW – 7KW) to allow for battery balancing and SOC calibration.

## Driving the Vehicle

### Operating Procedure – Starting the Vehicle



**Warning:** Vehicle noise may be reduced in some operation modes. The vehicle operator must remain aware of nearby vehicles or pedestrians at all times. Failure to comply may result in death, injury, or property damage.

<sup>3</sup> The key must be removed from the ignition switch, or the vehicle will not charge.



**Warning:** Exercise caution when starting the vehicle when parked or stopped on a steep slope. Do not release the brake until after the accelerator pedal has been engaged to reduce vehicle roll back distance. Failure to comply may result in death, personal injury, equipment, or property damage.

1. With foot on brake pedal, turn the key to start position.<sup>4</sup>
2. After a single 'chirp' is heard, release the key.
3. The system will run a self-check and activate.
4. After a double 'chirp' is heard, the display will show READY.



5. With foot on brake, select a gear.  
(D-N-R on the PACCAR gear selector)
6. The gear will be show in the PACCAR cluster
7. Disengage parking brake and drive.



**Warning:** Do not exceed the maximum vehicle speed (65 mph) while driving downhill. Failure to comply may result in equipment or property damage.

## Turning the Vehicle Off

1. With vehicle at a standstill, enable the park brake via parking brake knob.
2. Turn the key to the OFF position, system will initiate shutdown.
3. System will run a self-check and disable itself.
4. The vehicle state will momentarily change to OFF before the display turns off.

---

<sup>4</sup> The vehicle cannot be started if it is currently being charged.



## Turning on Cabin Heating

1. To turn on Cabin Heating, first press the Cabin Heating button indicated in the image (1).
2. A green LED in the center of the Cabin Heating button will illuminate, indicating that the Cabin Heating has been switched on.
3. Change the remaining HVAC controls (temperature knob, fan speed, fan direction) as usual for heating.



# Chapter 5 - Maintenance



**Warning:** Repair of high voltage (HV) components or the HV battery is very dangerous and could cause severe burns and electric shock. Never remove or disassemble any HV components, connectors, or cables in this vehicle – HV cables are colored orange for easy identification. All inspections and repairs must be conducted by an authorized and trained service dealer. Failure to comply may result in death or personal injury.



**Warning:** Do not touch or attempt to remove any orange colored HV cables, connectors, or components. Failure to comply may result in death or personal injury.



**Warning:** The HV system on this vehicle has no parts that an owner or unauthorized service technician can service. Under no circumstances should you open or tamper with the battery or other HV components. Always contact a certified service dealer. Do not touch or attempt to remove any orange colored HV cables, connectors, or components. Failure to comply may result in death or personal injury.



**Warning:** Do not tilt cab for maintenance following a collision. The tilting mechanism may be damaged, and a high voltage hazard might exist. Do not touch or attempt to remove any orange colored HV cables, connectors, or components. Failure to comply may result in death or personal injury.



**Caution:** The HV battery pack requires no routine owner maintenance. If the battery service icon illuminates, contact a PACCAR Dealership. Failure to comply may result in equipment damage.



**Note:** In the unlikely event of a fire, do not attempt to put out a battery fire using a fire extinguisher. Immediately contact your local fire emergency responders.

## NORMAL EV POWERTRAIN MAINTENANCE



**Warning:** Before performing any maintenance on the vehicle, place the ignition switch in the OFF position and remove the key. Additionally, if a 24V battery disconnect was optioned, place the 24V battery disconnect switch in the OFF position to ensure the system cannot be powered accidentally prior to completing maintenance.

The electric powertrain requires fluid inspections, as well as fluid replacements, at regular intervals. See chart below. Do not attempt to perform any type of maintenance or disassembly of the EV power control unit or EV motor assembly. Doing so may damage the component and/or electrical system.

Component	Fluid	Fill Volume	Check Frequency	Change Frequency (mi)
Drive Axle Lube	BASF 2986 FE 75W90 (Synthetic)	3.1gal (11.8L)	25,000 mi	100,000 mi
Powertrain Coolant		6 gal (22.7L)	Daily	100,000 mi
Cabin Heating Loop		3 gal (11.4L)	Monthly	100,000 mi
Battery Pack Chiller Coolant	TRP Extended Life Coolant (ELC) Prediluted 50/50	141kWh: 6gal (22.7L) 209kWh: 8gal (30.3L) 282kWh: 9gal (34.1L)	Daily	100,000 mi (change fluid) 50,000 mi (replace vent)
Air Compressor System Maintenance Oil	Castrol Alphasyn T46 or Chevron Cetus PAO 46	0.4gal (1.4L)	Find info in Bendix manual.	50,000 mi
Air Compressor/Dryer Filters	See service manual	See service manual	See service manual	See service manual
HV Battery Chiller Refrigerant	R134a	See service manual	As needed/required	N/A
HV Battery Chiller Lubricant	See service manual	See service manual	As needed/required	N/A
Air Conditioning Refrigerant	R134a	See service manual	As needed/required	N/A
HV Air Conditioning Condenser Lubricant	Check fill port label	0.26gal (1L)	As needed/required	N/A

# NORMAL VEHICLE CHASSIS MAINTENANCE



**Warning:** Before performing any maintenance on the vehicle, place the ignition switch in the OFF position and remove the key. Additionally, if a 24V battery disconnect was optioned, place the 24V battery disconnect switch in the OFF position to ensure the system cannot be powered accidentally prior to completing maintenance. Failure to comply may result in death or serious injury.

Follow the maintenance intervals as outlined in the truck OEM owner's manual for all necessary chassis inspections and maintenance.



**Note:** In a extended life coolant (ELC) filled cooling system, the freezing point should be maintained between -30 °F (-34 °C) and -43 °F (-42 °C).

## Fluid Level Inspection

Top off the cooling system when coolant does not rise to the level indicated as MIN on the surge tanks for both coolant systems. The powertrain surge tank is translucent which allows the coolant level to be seen. The HV battery pack chiller surge tank uses a sight glass to visually monitor fluid levels.

### *Electric Powertrain Coolant Level Inspection*

1. The fluid level should be between the MIN and MAX fill lines marked on the surge tank.
2. Fill levels below the MIN fill line should be top off using the procedure below.

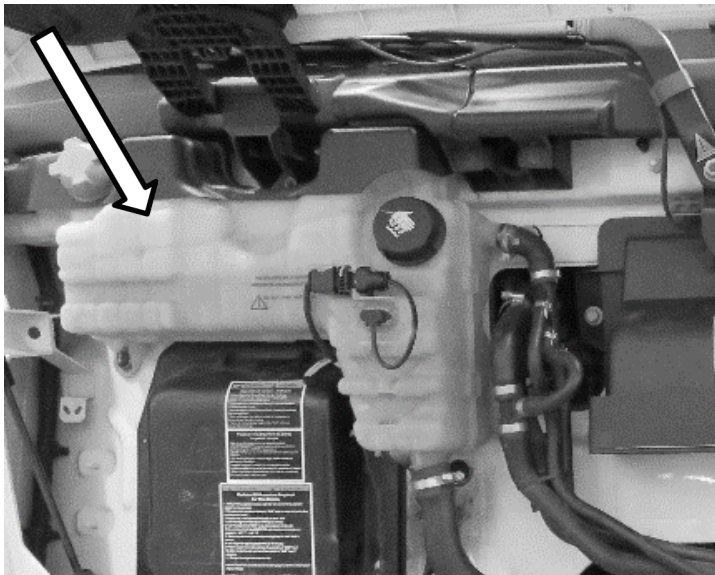



## Electric Powertrain Coolant Top Off



**Warning:** Before performing any maintenance on the vehicle, place the ignition switch in the OFF position and remove the key. Additionally, if a 24V battery disconnect was optioned, place the 24V battery disconnect switch in the OFF position to ensure the system cannot be powered accidentally prior to completing maintenance. Failure to comply may result in death or serious injury.



**Warning:** Removing the fill cap from a hot radiator can cause scalding coolant to spray out and burn you badly. Protect face, hands, and arms against escaping fluid and steam by covering the cap with a large, thick rag. Do not try to remove the cap until the surge tank cools down or if you see any steam or coolant escaping. In all situations, remove the cap slowly and carefully. Failure to comply may result in death or serious injury.

1. Wait at least 10 minutes following vehicle operation to allow coolant to cool.
2. Remove the surge tank cap (1).
  - **Do not remove** the surge tank coolant level sensor cap (2).
3. Fill system with premixed coolant to “MAX” level on the surge tank.



**Caution:** When adding fluid, be sure to use fluid of the same type. While many fluids have the same description and intended purpose, they should not be mixed due to incompatible additives. Mixing incompatible fluids may lead to equipment damage.



**Caution:** Failure to follow this procedure and maintain proper coolant level can cause system failure, resulting in equipment damage.



**Note:** Do not over fill a cooling system. Excess coolant may result in overflow, loss of antifreeze, and reduced corrosion protection.



**Note:** Do not use the pressure cap opening to fill the surge tank with fluid.



**Note:** Maximum recommended ELC concentration is 60% ELC and 40% water by volume.

### ***HV Battery Chiller Coolant Level Inspection***

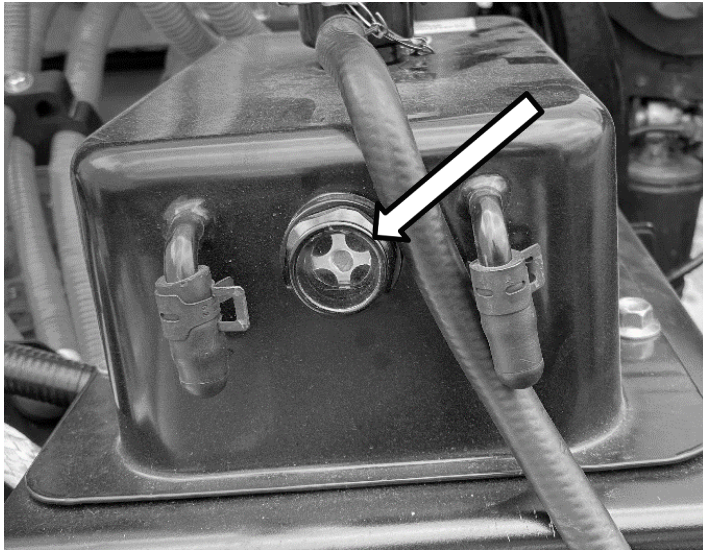

1. The fluid level should be between the MIN and MAX fill lines marked on the surge tank site glass (see graphic).
2. Fill levels below the MIN fill line should be top off using the procedure HV Battery Chiller Coolant Top Off.

### ***HV Battery Chiller Coolant Top Off***

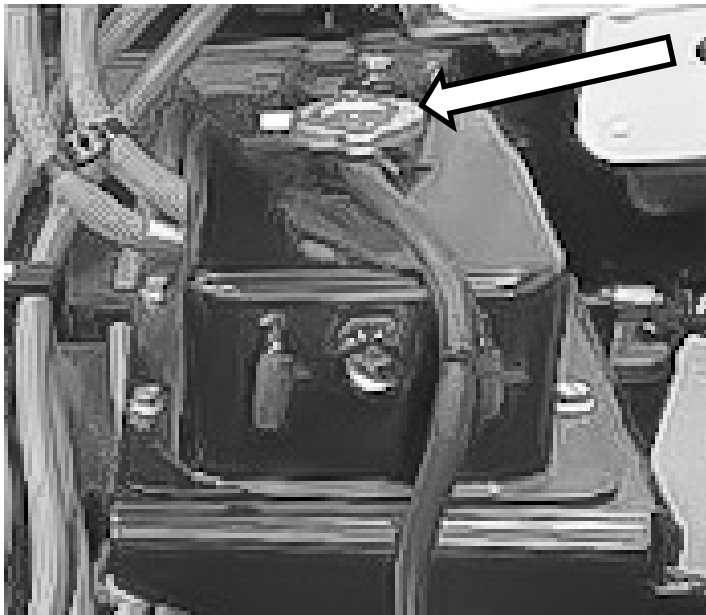

1. Wait at least 10 minutes following vehicle operation to allow coolant to cool.
2. Remove the surge tank cap (see graphic).
3. Fill system with premixed coolant to MAX level on the surge tank.

## ***Electric Powertrain Coolant Change Instructions***



**Warning:** Before performing any maintenance on the vehicle, place the ignition switch in the OFF position and remove the key. Additionally, if a 24V battery disconnect was optioned, place the 24V battery disconnect switch in the OFF position to ensure the system cannot be powered accidentally prior to completing maintenance. Failure to comply may result in death or serious injury.

Dana recommends that a vacuum purge and refill tool be used to drain and refill the cooling system to ensure the removal of air that may cause damage to the circulation pump.



**Important:** Carefully read the safety instructions that comes with your vacuum tool.

## ***HV Battery Chiller Coolant Change Instructions***



**Warning:** Before performing any maintenance on the vehicle, place the ignition switch in the OFF position and remove the key. Additionally, if a 24V battery disconnect was optioned, place the 24V battery disconnect switch in the OFF position to ensure the system cannot be powered accidentally prior to completing maintenance. Failure to comply may result in death or serious injury.

Dana recommends that a vacuum purge and refill tool be used to drain and refill the cooling system to ensure the removal of air that may cause damage to the circulation pump.



**Note:** Carefully read the safety instructions that comes with your vacuum tool.

## Long Term Storage

<b>Battery EV Storage Requirements Summary</b>			
<b>Duration</b>	Up to 7 Days	8 to 30 Days	Over 30 Days <sup>*</sup>
<b>SOC (not on charger)</b>	40% - 70% <sup>**</sup>		
<b>Environment (Avoid Direct Sunlight)</b>	Shaded/Covered Area	Shaded/Covered Area	Shaded/Covered Area (Temperature controlled building recommended)
<b>Temperature Inside the Battery Enclosure<sup>***</sup></b>	-35°C to 65°C (-31°F to 149°F)	0°C to 40°C (32°F to 104°F)	0°C to 40°C (32°F to 104°F)
<b>Parking Brake</b>	Engaged		
<b>24V Disconnect Switch</b>	Engaged (24V Off)		

<sup>*</sup> If Parked for 90 Days	Plug vehicle into charger for at least 24 hours (100% SOC) to balance batteries before driving.
<sup>**</sup> If SOC falls below 40%	Plug vehicle into charger to bring SOC every 14 days.
<sup>***</sup> If exposed to temperatures below 0°C (32°F) or above 40°C (104°F) at any time	Plug vehicle into charger for 2 hours to bring batteries to operating temperature before driving.

**For more detailed instructions, refer to CATL owner's manual**



Your Servicing Dealer Is:



Need Help? Give Us A Call - 24  
Hours a Day  
1-800-KW-ASSIST  
1-800-592-7747

KENWORTH TRUCK COMPANY  
P.O. Box 1000  
Kirkland, Washington 98083-1000  
(425) 828-5000

CANADIAN KENWORTH COMPANY  
6711 Mississauga Road N.  
Mississauga, Ontario L5N 4J8  
(905) 858-7000

Do not remove the manual from vehicle.  
Before operating vehicle study the manual carefully.  
Read and understand all Warnings, Cautions and Notes.

Y53-6185-1A1 © 2022 Kenworth Truck Company