

PACCAR AXLES

DX-40

Operator's Manual
40k Rear Axle



Safety

1

Maintenance

2

Appendix

3

© 2023 PACCAR Inc. - All Rights Reserved

This manual illustrates and describes the operation of features or equipment which may be either standard or optional on this vehicle. This manual may also include a description of features and equipment which are no longer available or were not ordered on this vehicle. Please disregard any illustrations or descriptions relating to features or equipment which are not on this vehicle. PACCAR reserves the right to discontinue, change specifications, or change the design of its vehicles at any time without notice and without incurring any obligation. The information contained in this manual is proprietary to PACCAR. Reproduction, in whole or in part, by any means is strictly prohibited without prior written authorization from PACCAR Inc.

Chapter 1 | SAFETY

Foreword.....	5
Using this Manual.....	5
Safety Messages and Notes.....	6
Illustrations.....	6

Foreword

This supplement contains new or revised information designed to replace the similarly or identically titled topics found in the operator's manual. Read and follow all safety instructions. Keep this manual with the equipment along with the OEM manuals. If the equipment is traded or sold, give the manual to the new owner. The information, specifications, and recommended maintenance guidelines in this manual are based on information in effect at the time of printing. PACCAR reserves the right to make changes at any time without obligation. If you find differences between your instruments and the information in this manual, contact an authorized PACCAR dealer. When replacement parts are needed, we recommend using only genuine parts from PACCAR.

Using this Manual

Please take the time to get acquainted with your vehicle by reading this Operator's Manual. We recommend that you read and understand this manual from beginning to

end before you operate this equipment. This manual contains useful information for the safe and efficient operation of this equipment. It also provides service information, with an outline for performing safety checks and basic preventive maintenance inspections. When replacement parts are needed, we recommend using only genuine PACCAR parts. We have tried to present the information needed to learn about functions, controls, and operation—and to present it as clearly as possible. Occasionally, you may need to reference this manual, and we hope you find it easy to use.



NOTE

After you have read this manual, it should be stored in the cab for convenient reference and remain with this truck when sold.

Your vehicle may not have all the features or options mentioned in this manual. Therefore, you should pay careful attention to the instructions that pertain to just your vehicle. In addition, if your vehicle is equipped with special equipment or options

not discussed in this manual, consult your dealer or the manufacturer of the equipment.

There are several tools built into this manual to help you find what you need quickly and easily; first is the Table of Contents. Located at the front of the manual, this table arranges the subject matter into chapters, which can be quickly referenced using the numbers shown in the outer margin. The first page of each chapter presents a list of the major subjects contained in that chapter. Cross-referenced citations can also help you find information. If more information on the current subject is located elsewhere in the manual, a cross-reference may be provided, such as "see [Safety Messages and Notes](#) on page 6." Finally, you will find a helpful index at the back of the manual which lists the subjects covered alphabetically.

All information contained in this manual is based on the latest production information available at the time of publication. If you find differences between your instruments and the information in this manual, contact an authorized PACCAR dealer. PACCAR reserves the right to make changes at any time without notice.

Safety Messages and Notes

Read and follow ALL safety messages in this manual. When followed, injury to yourself and others, damage to equipment and/or property, or other unknown hazards are reduced. Both safety messages and notes are emphasized using a safety message symbol and one of three signal words: WARNING, CAUTION, or NOTE. **Do not** ignore any of these messages.

Warnings



Safety messages that follow this symbol and signal word provide a warning concerning operating procedures, actions, or a lack of action that could result in death or injury. An unheeded warning may also result in damage to equipment, property, or the environment. Warning messages will identify the hazard, how to avoid it, and the probable consequence of not avoiding the hazard.
Example:



WARNING

DO NOT change hot engine oil as you could be burned. Let the engine cool down before changing the engine oil. Failure to comply may result in death, personal injury, equipment damage, or property damage.

Cautions



Safety messages that follow this symbol and signal word provide a caution against operating procedures, actions, or a lack of action that could result in equipment, property, or environmental damage. Caution messages will identify the hazard, how to avoid it, and the probable consequence of not avoiding the hazard.
Example:



CAUTION

DO NOT operate your vehicle with insufficient oil pressure as this will cause

serious engine damage. Failure to comply may result in equipment or property damage.

Notes



Messages that follow this symbol and signal word provide important information that, while not safety related, should still be followed. A note will provide information that may be useful to the reader: clarifying the topic, providing valuable insight into the topic or process, or saving the reader time and effort.
Example:



NOTE

Pumping the accelerator pedal will not assist in starting the engine.

Illustrations

Some of the illustrations found in this manual are generic, and may not look

exactly like the parts or assemblies you find installed on your vehicle. When an illustration differs from what you see physically present on your vehicle, the language describing the procedure will still be correct for your application.

Chapter 2 | MAINTENANCE

Preventive Maintenance.....	9
Preventative Maintenance Intervals.....	11
Preventative Maintenance Schedule - On Highway / Linehaul Application.....	11
Preventative Maintenance Schedule - City Delivery Application.....	12
Checking Oil Level.....	13
Check and Adjust Axle Oil Level.....	13
Rear Axle Oil Fill Volumes.....	14
Where is the axle fill and drain plug?.....	14

Preventive Maintenance

Preventive maintenance begins with the daily checks listed in your vehicle operator's manual. Routine vehicle checks can help avoid many large, expensive, and time consuming repairs, and will contribute to better, safer, and longer vehicle operation. Neglect of recommended maintenance can void your vehicle's warranty. Some maintenance operations demand skills and equipment you may not have. For such situations, please take your vehicle to a PACCAR Powertrain distributor.

 **WARNING**

Always move the vehicle off-road to a safe location for servicing. Failure to comply may result in death, personal injury, equipment damage, or property damage.

 **WARNING**

Before attempting any procedure in the engine compartment, stop the en-

gine and let it cool down. Hot fluids and components can burn skin on contact. Failure to comply may result in death, personal injury, equipment damage, or property damage.

 **WARNING**

If the engine must be running to inspect, be alert and cautious around the engine at all times. Failure to comply may result in death, personal injury, equipment or property damage.

 **WARNING**

If work must be done with the engine running, always:

- Ensure that the transmission is in neutral (**N**) or park (**P**)
- Set the parking brake
- Block the wheels

Failure to comply may result in death, personal injury, equipment or property damage.

 **WARNING**

DO NOT wear neckties, jewelry, and/or loose clothing, and secure long hair to avoid getting caught in the fan blades or other moving engine parts. Failure to comply may result in death, personal injury, equipment damage, or property damage.

 **WARNING**

Always support the vehicle with appropriate safety stands if it is necessary to work underneath the vehicle. A jack is not adequate for this purpose. Failure to comply may result in death, personal injury, equipment or property damage.

 **WARNING**

When working underneath the vehicle with the wheels on the ground (not supported), make sure that

- The vehicle is on hard, level ground.
- The parking brake is applied.
- All wheels are blocked (front and rear).
- The ignition key is removed to prevent the engine from starting.

Failure to comply may result in death, personal injury, equipment damage or property damage.

 **WARNING**

NEVER start or let the engine run in an enclosed, unventilated area. Engine exhaust fumes contain carbon monoxide, a colorless and odorless gas. Carbon monoxide can be fatal if inhaled. Failure to comply may result in property damage, personal injury, or death.

For towing the vehicle, please follow the safety procedures below:

 **WARNING**

Refer to the towing procedure training on PACCAR.net for lifting points on vehicle restrictions, power disconnection instructions, driveline removals, and e-Axles disengages Failure to comply may result in death, personal injury, equipment or property damage.

The tables on the following pages contain maintenance tasks. These tasks should be performed at the interval labeled at the top of the table, which are based either on vehicle mileage, or vehicle mileage and time passed since the last time that task was performed. Some tasks depend on vehicle application -- or how and where the vehicle is operated. These tasks will have the words ON-HIGHWAY, OFF-HIGHWAY, CITY DELIVERY, or VOCATIONAL after the description and should be performed if the vehicle is operated for that application:

- ON-HIGHWAY – Applications where the vehicle is only used on paved roads during normal operation.

- OFF-HIGHWAY – Applications where the vehicle may be driven off the pavement on a regular basis, even if it is an infrequent basis and/or for a brief time period.
- CITY DELIVERY – Applications where frequent start and stopping is required during normal operation, and highway use is infrequent and for short intervals.
- VOCATIONAL – Applications based on truck configuration and use and not on operating environment. Vocational vehicle components must meet the requirements needed for its specific application (such as delivery, construction, fire service, refuse, and busing). A truck can be Vocational in addition to other application types. Vehicles that fall into more than one application category should observe the earliest and more limiting application's maintenance requirements.

If there are questions regarding which intervals to follow, please contact a PACCAR Powertrain distributor. Consult the supplier for specific recommendations where discrepancies develop between the

recommendations in the following maintenance tables and the component supplier recommendations.

Preventative Maintenance Intervals

DX-40 Tandem Rear Axle Preventative Maintenance Intervals

I	A	B	C	D	E
At first 15,000 mi/ 24,000 km or at first PM	15,000 mi/24,000 km/Monthly	30,000 mi/48,000 km	60,000 mi/96,000 km/ 6 Months	120,000 mi/ 192,000 km/ Annually	240,000 mi/ 384,000 km

Preventative Maintenance Schedule - On Highway / Linehaul Application

2

Preventative Maintenance Schedule - On Highway / Linehaul Application

System	Component	Task	I	A	B	C	D	E
DX-40	Axle Assembly	Check oil level and inspect for leaks. See Checking Oil Level on page 13.			.			
		Visually inspect for damage or leaks.			.			
		Drain and replace 75W90 full synthetic lubricant.	500,000 miles / 804,672 km / 4 years					
	Breather	Check the operation. If the cap does not rotate freely, replace.			.			
	Axle shaft	Tighten the rear axle flange nuts to the specified torque value.					.	

Preventative Maintenance Schedule - City Delivery Application

Preventative Maintenance Schedule - City Delivery Application

System	Component	Task	I	A	B	C	D	E	
DX-40	Axle Assembly	Check oil level and inspect for leaks. See Checking Oil Level on page 13.		.					
		Visually inspect for damage or leaks.		.					
		Drain and replace 75W90 full synthetic lubricant.	250,000 miles / 402,336 km / 3 years						
	Breather	Check the operation. If the cap does not rotate freely, replace.		.					
	Axle shaft	Tighten the rear axle flange nuts to the specified torque value.					.		

Checking Oil Level

For oil reservoir with side filler plugs (transmission, axles, steering gear boxes, transfer cases, etc.) the oil must be level with the filler opening. Use care when checking the oil level with a finger. Just because you can reach the oil level with a finger does not mean the oil level is correct.

Improper Oil Level



Correct Oil Level



Check and Adjust Axle Oil Level

Checking the oil level is part of normal maintenance. When checking the oil level, it is recommended that a visual inspection for leaks be performed. Additionally, check condition of the fluid itself. Contact an authorized PACCAR service center if a leak is found, if the oil appears cloudy or

contaminated, or the oil level is abnormally low.

1. Park the vehicle on a level surface and block the wheels to prevent the vehicle from moving.

Wait 5 minutes before checking the oil if the axle is at normal operating temperature. If the vehicle is in colder climates, wait 15 minutes before checking the oil level.

2. Locate and remove the fill plugs on the axle housing. See [Where is the axle fill and drain plug?](#) on page 14.
3. Remove the fill plug and check that the oil is even with the bottom of the fill plug hole.
 - If the oil flows from the hole when the plug is loosened, the oil level is high, let the oil drain to the correct level.
 - If the oil level is below the bottom of the fill plug hole, add the specified oil.
4. Clean, install and tighten the fill plug to 25-50 lb-ft (34-68 Nm).

Rear Axle Oil Fill Volumes DX-40 Tandem Rear Axle

Axle Position	Liters	Quarts	Pints
Forward	11.3	11.9	23.9
Rear	9.3	9.8	19.7



NOTE

The table shows the approximate axle fill volume only (which includes volume required to fill hubs). The actual amount of oil required to get the oil up to the proper level (at the check plug) will vary with pinion angle.

PACCAR only approves the use of 75W90 API GL-5 full synthetic lubricant.

Where is the axle fill and drain plug?

Forward-Rear Axle

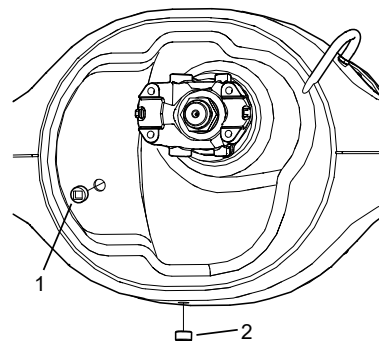

1. Fill Plug (Level Checking Plug)
2. Drain Plug

Rear-Rear Axle

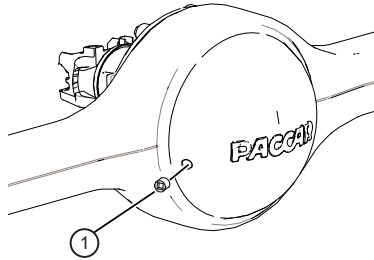

1. Fill Plug (Level Checking Plug)

Chapter 3 | APPENDIX

DX-40 Rear Axle Warranty.....17

3

DX-40 Rear Axle Warranty

Products Warranted

This warranty applies to new PACCAR tandem rear axles which have been installed by an Original Equipment Manufacturer (OEM) in vehicles sold and used in the United States¹ or Canada and operated in these applications:

On-Highway/ LineHaul	Average annual mileage exceed 60,000 per year Operate primarily on improved driving surfaces such as asphalt or concrete Average 30 miles between start and stop periods
Pick up and Delivery/ Medium Duty	Lower mileage operations (less than 60,000 miles/year) Generally, on-road service (less than 10% off-road) An average of three (3) miles between starting and stopping

Warranty Coverage – DX-40 Tandem Rear Axle

This warranty covers any failures of the rear axle which result, under normal use and service, from a defect in material or factory workmanship (warrantable failure). This coverage begins on the vehicle's date of delivery and ends at the time and mileage shown, whichever occurs first to the first purchaser or first lessee by PACCAR.

On-Highway/Line Haul	5 years / 750,000 miles (1,207,008 km)
Pick up and Delivery/ Medium Duty	2 years / Unlimited Miles

PACCAR and Owner Responsibilities

PACCAR Responsibilities

PACCAR will pay for all parts and labor needed to repair the damage to the rear axle resulting from a warrantable failure. PACCAR will pay for the lubricating oil, pinion and through shaft seals, and other

maintenance items that are not reusable due to the warrantable failure.

PACCAR will pay for reasonable labor costs for rear axle removal and reinstallation when necessary to repair a warrantable failure.

PACCAR will not pay any cost for towing a vehicle.

Owner Responsibilities

The owner is responsible for the operation and maintenance of the axle as specified in the applicable PACCAR Operator's Manual. The owner is also responsible for providing proof that all recommended maintenance has been performed.

Before the expiration of the applicable warranty, the owner must notify a PACCAR authorized dealer of any warrantable failure and make the vehicle available for repair by such facility. The warrantable failure must be brought to the attention of a PACCAR authorized dealer within 30 days of discovery. The owner must also deliver the vehicle to the authorized repair facility during the warranty period unless delivery is impossible because the vehicle has been disabled by a warrantable failure. The

¹ United States includes American Samoa, the Commonwealth of Northern Mariana Islands, Guam, Puerto Rico, and the U.S. Virgin Islands.

owner is responsible for the cost of lubricating oil and other maintenance items provided during warranty repairs unless such items are not reusable due to the warrantable failure. The owner is responsible for communication expenses, meals, lodging and similar costs incurred as a result of a warrantable failure. The owner is responsible for warrantable repairs unrelated to the rear axle and for “downtime” expenses, cargo damage, towing, fines, all applicable taxes, all business costs and other losses resulting from a warrantable failure.

Warranty Limitations - PACCAR Rear Axle

Your sole and exclusive remedy against PACCAR and the selling dealer arising from your purchase and use of this rear axle is limited to the repair or replacement of “warrantable failures” at authorized United States and Canadian PACCAR dealers, subject to PACCAR’s time and mileage limitations of the warranty. The accrued time and mileage is calculated when the vehicle is brought into an authorized dealer for correction of warrantable failures. Any claim beyond 45 days from date of repair will not be

accepted or honored under this warranty program. PACCAR reserves the right to require that all applicable failed materials are available and/or returned to PACCAR for review and evaluation. Failures, other than those resulting from defects in material or factory workmanship, are not covered by this warranty. PACCAR is not responsible for failures or damage resulting from what PACCAR determines to be abuse or neglect, including, but not limited to: damage due to accident; operation without adequate lubricants or using incorrect lubricant specifications; lack of maintenance of lubricating oil; improper installation, adjustment, repair or modification (including the use of unauthorized attachments or changes or modification in the vehicle’s configuration, usage, or vocation from that which was originally approved by PACCAR); loading beyond the specified maximum vehicle weight or altering engine power settings to exceed the axle and/or driveline capacity; or operating the vehicle in a vocation other than what was determined when the vehicle was put into service. PACCAR is also not responsible for failures caused by water, dirt or other contaminants in the oil. Failure of replacement parts used in repairs due to the above non-warrantable

conditions is not warrantable. PACCAR is not responsible for the cost of any repairs, replacements or adjustments to a covered component (1) associated with noise; (2) resulting from the use or installation of non-genuine PACCAR components or materials; (3) due to vibration associated with improper operation or misapplication of drivetrain components; and (4) damage resulting from corrosion.

This warranty does not apply to accessories supplied by the vehicle original equipment manufacturer (OEM) which are covered by the OEM vehicle warranty. This warranty does not apply to self-contained traction equalizers and oil filters. The use of locking differentials will result in the exclusion of axle shafts from warranty considerations.

PACCAR does not warrant lubricants, pinion and through shaft seals or any other part which is considered a maintenance item.

Parts used to repair a warrantable failure may be new parts, approved rebuilt parts, or repaired parts. PACCAR is not responsible for failures resulting from the use of parts not approved by PACCAR. A new approved or rebuilt part used to repair a warrantable failure assumes the identity

of the part it replaced and is entitled to the remaining coverage hereunder.

PACCAR DOES NOT COVER WEAR OR WEAROUT OF COVERED PARTS.

THIS WARRANTY SET FORTH HEREINAFTER ARE THE SOLE WARRANTIES MADE BY PACCAR IN REGARD TO THESE REAR AXLES.

THIS LIMITED WARRANTY IS THE SOLE WARRANTY MADE BY PACCAR AND THE SELLING DEALER. EXCEPT FOR THE ABOVE LIMITED WARRANTY, PACCAR AND THE SELLING DEALER MAKE NO OTHER WARRANTIES, EXPRESS OR IMPLIED. PACCAR AND THE SELLING DEALER EXPRESSLY DISCLAIM ANY WARRANTY OF MERCHANTABILITY OR WARRANTY OF FITNESS FOR A PARTICULAR PURPOSE.

PACCAR AND THE SELLING DEALER SHALL NOT BE LIABLE FOR INCIDENTAL OR CONSEQUENTIAL DAMAGES INCLUDING, BUT NOT LIMITED TO: LOSS OF INCOME OR LOST PROFITS; ENGINE OR VEHICLE DOWNTIME; THIRD PARTY DAMAGE, INCLUDING DAMAGE OR LOSS TO OTHER ENGINES, VEHICLES OR PROPERTY, ATTACHMENTS, TRAILERS AND CARGO; LOSS OR DAMAGE TO

**PERSONAL CONTENTS;
COMMUNICATION EXPENSES;
LODGING AND/OR MEAL EXPENSES;
FINES; APPLICABLE TAXES OR
BUSINESS COSTS OR LOSSES;
ATTORNEYS' FEES; AND ANY
LIABILITY YOU MAY HAVE IN RESPECT
TO ANY OTHER PERSON OR ENTITY.**

This warranty gives you specific legal rights, and you may also have other rights which vary from state to state.

PACCAR^{inc}
Powertrain
P.O. Box 1518
Bellevue, WA 98009

Y53-1270-1C1