



**KENWORTH**

**Operator's Manual**

**T440, T470**

**Do not remove this manual from vehicle.  
Before operating vehicle study this manual carefully.  
Read and understand all Warnings, Cautions and Notes.**



# Contents

---

<b>Safety</b>	<b>1</b>
<b>Emergency</b>	<b>2</b>
<b>Controls</b>	<b>3</b>
<b>Driving</b>	<b>4</b>
<b>Maintenance</b>	<b>5</b>
<b>Information</b>	<b>6</b>
<b>Index</b>	<b>7</b>

# Contents

---

## **©2017 PACCAR Inc - All Rights Reserved**

This manual illustrates and describes the operation of features or equipment which may be either standard or optional on this vehicle. This manual may also include a description of features and equipment which are no longer available or were not ordered on this vehicle. Please disregard any illustrations or descriptions relating to features or equipment which are not on this vehicle.

PACCAR reserves the right to discontinue, change specifications, or change the design of its vehicles at any time, without notice and without incurring any obligation.

The information contained in this manual is proprietary to PACCAR. Reproduction, in whole or in part, by any means is strictly prohibited without prior written authorization from PACCAR Inc.







## INTRODUCTION

About This Manual . . . . .	1-3
Safety Alerts . . . . .	1-3
Vehicle Safety . . . . .	1-5
Environmental Protection . . . . .	1-6
Data Recorder . . . . .	1-7
Repairs . . . . .	1-7
Greenhouse Gas Certification . . . . .	1-8
Additional Sources of Information . . . . .	1-9

## CAB AND FRAME ACCESS

Safety . . . . .	1-10
Door Lock and Keys . . . . .	1-11
Remote Keyless Entry (Option) . . . . .	1-12

## GETTING TO YOUR ENGINE

Hood Hold Downs. . . . .	1-14
Hood Tilt . . . . .	1-14
Hood Safety Cable . . . . .	1-15

**SEATS AND RESTRAINTS**

Introduction . . . . .	1-16
Safety Restraint Belts . . . . .	1-17
Tether Belts . . . . .	1-21
Komfort-Latch® Feature . . . . .	1-22
During Pregnancy. . . . .	1-23
Belt Damage and Repair. . . . .	1-24
Safety Restraint Tips . . . . .	1-24

**START-UP**

Introduction . . . . .	1-26
Safe Vehicle Operation . . . . .	1-26
Vehicle Loading. . . . .	1-27
Emergency Equipment . . . . .	1-28
Driver's Check List . . . . .	1-28

## INTRODUCTION

### About This Manual

Congratulations! Your selection of a Kenworth truck was a wise investment. Kenworth trucks are recognized as the industry standard for quality and reliability.

Please take the time to get acquainted with your vehicle by reading this Operator's Manual. We recommend that you read and understand this manual from beginning to end before you operate your truck. This manual explains the safe, efficient operation and maintenance of your Kenworth.



#### NOTE

After you've read this manual, it should be stored in the cab for convenient reference and remain with this truck when sold.

Your Kenworth may not have all the features or options mentioned in this manual. Therefore, you should pay careful attention to the instructions that pertain to just your vehicle. In addition, if your vehicle is equipped with special equipment or options not discussed in this manual, consult your dealer or the manufacturer of the equipment.

All information contained in this manual is based on the latest production information available at the time of publication. Kenworth Truck Company reserves the right to make changes at any time without notice.

### Safety Alerts

Please read and follow all of the safety alerts contained in this manual. They are there for your protection and information. These alerts can help you avoid injury to yourself, your passengers, and help prevent costly damage to the vehicle. Safety alerts are highlighted by safety alert symbols and signal words such as "WARNING", "CAUTION", or "NOTE". Please do not ignore any of these alerts.

# INTRODUCTION

1

## WARNING

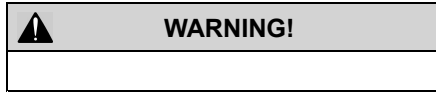

The safety message following this symbol and signal word provides a warning against operating procedures which could cause injury or even death. They could also cause equipment or property damage. The alert will identify the hazard, how to avoid it, and the probable consequence of not avoiding the hazard.

### Example:

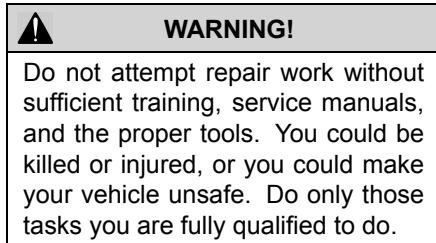

## CAUTION

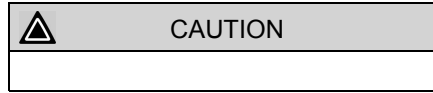

The safety alert following this symbol and signal word provides a caution against operating procedures which could cause equipment or property damage. The alert will identify the hazard, how to avoid it, and the probable consequence of not avoiding the hazard.

### Example:

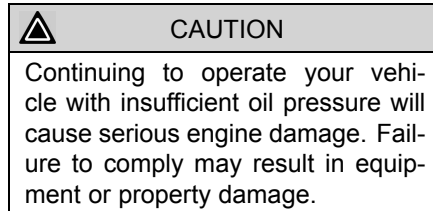

## NOTE

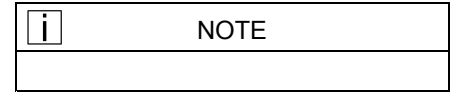

The alert following this symbol and signal word provides important information that is not safety related but should be followed. The alert will highlight things that may not be obvious and is useful to your efficient operation of the vehicle.

### Example:

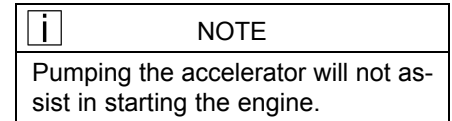

## Vehicle Safety



### WARNING!

Do not drive after drinking alcohol or using other substances that may affect the senses, including prescription medications. Your reflexes, perceptions, and judgment can be affected by even a small amount of alcohol or other substances, and can cause a serious or even fatal accident. Failure to comply may result in death, personal injury, or equipment and property damage.



### WARNING!

Do not text while driving. Your reflexes, perceptions, and judgment can be affected while texting or using any other form of mobile messaging while driving. Failure to comply may result in death, personal injury, or equipment and property damage.

Make sure your Kenworth is in top working condition before heading out on the road, it is the responsible driver's duty to do so. Inspect the vehicle according to the Driver's Check List beginning on page 1-28.

Every new Kenworth vehicle is designed to conform to all Federal Motor Vehicle Safety Standards applicable at the time of manufacture. Even with these safety features, continued safe and reliable operation depends greatly upon regular vehicle maintenance. Follow the maintenance recommendations found in Preventive Maintenance on page 5-7. This will help preserve your investment.

Keep in mind that even a well maintained vehicle must be operated within the range of its mechanical capabilities and the limits of its load ratings. See the Tire and Rim Weight Ratings label on the driver's door edge.

Safe driving is only possible with the proper concentration on the driving task. Keep distraction to a minimum to improve your concentration. Examples of distractions may include radio controls, GPS navigation controls, cellular telephone calls, cellular text messages, reading or reaching for something on the floor. Minimizing your distractions will improve safe driving and will help avoid an accident involving death or personal injury.

Be aware of local regulations that may prohibit the use of cellular telephones while driving. In addition to being an unsafe practice, it may be against local or federal ordinances to use cellular devices while operating the vehicle.

This manual is not a training manual. It cannot tell you everything you need to know about driving your Kenworth vehicle. For that you need a good training program or truck driving

## INTRODUCTION

1

school. If you have not been trained, get the proper training before you drive. Only qualified drivers should drive this vehicle.

### Environmental Protection

 <b>WARNING!</b>
Diesel engine exhaust and some of its constituents are known to the State of California to cause cancer, birth defects, and other reproductive harm. Other chemicals in this vehicle are also known to the State of California to cause cancer, birth defects or other reproductive harm. This warning requirement is mandated by California law (Proposition 65) and does not result from any change in the manner in which vehicles are manufactured.

Some of the ingredients in engine oil, hydraulic oil, transmission and axle oil, engine coolant, diesel fuel, air conditioning refrigerant (R-134a and PAG oil), batteries, etc., may contaminate the environment if spilled or not disposed of properly. Non-compliance with environmental

regulations can result in fines and/or jail terms. Contact your local government agency for information concerning proper disposal.

#### California Proposition 65 Warning

- Diesel engine exhaust and some of its constituents are known to the State of California to cause cancer, birth defects, and other reproductive harm.
- Other chemicals in this vehicle are also known to the State of California to cause cancer, birth defects or other reproductive harm.
- Battery posts, terminals, and related accessories contain lead and lead compounds, chemicals known to the State of California to cause cancer and reproductive harm. Wash hands after handling.



## Data Recorder

California Vehicle Code - Section 9951- Disclosure of Recording Device

Your vehicle may be equipped with one or more recording devices commonly referred to as "event data recorders (EDR)" or "sensing and diagnostic modules (SDM)". If you are involved in an accident, the device(s) may have the ability to record vehicle data that occurred just prior to and/or during the accident. For additional information on your rights associated with the use of this data, contact

- the California Department of Motor Vehicles - Licensing Operations Division  
– or –
- [www.dmv.ca.gov](http://www.dmv.ca.gov)

## Repairs



### WARNING!

Do not attempt repair work without sufficient training, service manuals, and the proper tools. You could make your vehicle unsafe. Do only those tasks you are fully qualified to do. Failure to comply may result in personal injury, death, or equipment and property damage.



### WARNING!

Modifying your vehicle can make it unsafe. Some modifications can affect your vehicle's electrical system, stability, or other important functions. Before modifying your vehicle, check with your dealer to make sure it can be done safely. Improper modifications may result in death, personal injury, or equipment and property damage.

Your dealer's service center is the best place to have your vehicle repaired. You can find dealers all over the country with the equipment and trained personnel to get you back on the road quickly—and keep you there.

Your vehicle is a complex machine. Anyone attempting repairs on it needs good mechanical training and the proper tools. However, all warranty repairs must be performed by an authorized service facility. If you aren't an experienced mechanic, or don't have the right equipment, please leave all repairs to an authorized service facility. They are the ones best equipped to do the job safely and correctly.

To find a dealer near you, give us a call toll-FREE at 1-800-KW-ASSIST (1-800-592-7747) 24-7-365 days a year or visit us online at [www.kenworth.com](http://www.kenworth.com) and click on

# INTRODUCTION

1

the "dealers" link. When it comes time for service work, your Kenworth Dealer will need your Vehicle Identification Number (VIN), see Vehicle Identification on page 6-4.

## Maintenance Manuals

If you do decide to do any complex repair work, you'll need the maintenance manuals. Order them from your authorized dealer. Please provide your Chassis Serial Number when you order, to be sure you get the correct manuals for your vehicle. Allow about four weeks for delivery. There will be a charge for these manuals.

## Final Chassis Bill of Material

A complete, non-illustrated computer printout listing of the parts used to custom-build your vehicle is available through the dealer from whom you purchased your vehicle.

## Greenhouse Gas Certification

This vehicle may be equipped with components that are identified as Greenhouse Gas Certified components (GHG). A label on the door is printed with codes that identify the components manufactured on the vehicle that are part of the GHG certification. The codes are translated in the following table:

Emission Control Identifier	Emissions Related Components
VSL, VSLS, VSLE, or VSLE	Engine Software parameters that affect the Vehicle Speed Limiter
IRT5, IRTE	Engine software parameters that affect the automatic engine shutdown timer
ATS	Aerodynamic side skirts and/or fuel tank fairings
ARF ARFR	Aerodynamic roof fairing Adjustable height aerodynamic roof fairing
TGR	Gap reducing fairing (tractor to trailer)
LRRR, LRRD, or LRRS	Greenhouse Gas (GHG) Tires

## **Additional Sources of Information Installed Equipment - Operator's Manuals**

Major component suppliers to Kenworth also supply operation manuals specific to their products. Additional manuals and other pieces of literature are included in the glove box literature package. Look for information on products such as the engine, driver's seat, transmission, axles, wheels, tires, ABS/ESC (if applicable) and radio. If you are missing these pieces of literature, ask your Kenworth Dealer for copies.

## **Other Sources**

Another place to learn more about trucking is from local truck driving schools. Contact one near you to learn about courses they offer.

Federal and state agencies such as the department of licensing also have information. The Interstate Commerce Commission can give you information about regulations governing transportation across state lines.

# CAB AND FRAME ACCESS

## Safety

The following cab and frame entry/exit procedure recommendations were prepared with personal safety foremost in mind.



### WARNING!

Do not jump out of the cab or get into the cab without proper caution. You could slip or fall, possibly suffering a injury or death. You could slip and fall if the steps are wet or icy, or if you step in fuel, oil, or grease.

### To help avoid personal injury due to a slip or fall:

- Always face the vehicle when accessing or leaving the cab or frame access area.

- Use three points of contact (two feet one hand or one foot two hands) to grip the steps or handholds whenever possible and look where you are going.
- Use even more care when steps and handholds (or footwear) are wet, coated with ice, snow, mud, oil, fuel, or grease.
- Do not climb onto and off the deck plate, use steps and grab handle provided. If there is no deck plate, or if proper steps and grab handles are not provided, do not climb onto the area behind the cab.
- Keep steps clean. Clean any fuel, oil, or grease off the steps before entering the cab.



### WARNING!

Do not step on vehicle components without anti-skid surfaces or use components not designed for entry-and-exit use. You could fall and injure or kill yourself if you step onto a slippery surface.

- Do not step onto the surface of a fuel tank. A fuel tank is not a step. The tank surface can get very slippery, and you might not be able to prevent a fall. Use only the steps and handholds provided, not chain hooks, quarter fenders, etc.



### WARNING!

Always reinstall the battery compartment cover (step) before entering the cab. Without the battery cover in place, you could slip and fall, resulting in possible injury to yourself.

<b>i</b>	<b>NOTE</b>
<p>Any alteration (adding bulkheads, headache racks, tool boxes, etc.) behind the cab that affects the utilization of grab handles, deck plates or frame access steps installed by Kenworth must comply with Federal Motor Carrier Safety Regulation 399.</p>	

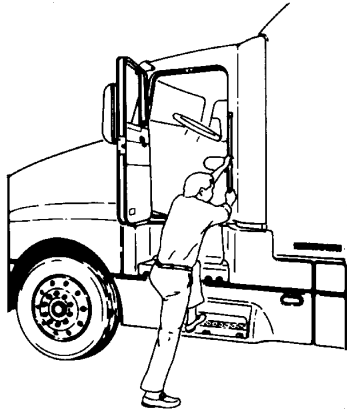

## Door Lock and Keys

Doors can be locked from the inside by using the lock button. Close the door then push the button down to lock. Doors automatically unlock when you open them from inside, and can be locked from the outside with the key only.

As standard equipment, two keys are provided for the doors and ignition. When necessary, additional locks and keys are provided for storage compartments.

**To lock or unlock the doors from outside the cab:**

- Insert the key in the door lock.
- Turn the key toward the rear door frame to lock; forward to unlock.

<b>⚠</b>	<b>WARNING!</b>
<p>To lessen the chance and/or severity of personal injury in case of an accident, always lock the doors while driving. Along with using the lap/shoulder belts properly, locking the doors helps prevent occupants from being thrown from the vehicle. Failure to comply may result in personal injury or death.</p>	

# CAB AND FRAME ACCESS

1

## Remote Keyless Entry (Option)

This vehicle may be equipped with a Remote Keyless Entry (RKE) system that adds security and convenience to your Kenworth truck. The system will lock or unlock the driver's door and passenger's door with the key fob and alert you with parking lights when the selected doors are locked or unlocked. The system includes two key fobs that provide secure rolling code technology that prevents someone from recording the entry signal.

FCC ID: L2C0031T IC: 3432A-0031T

FCC ID: L2C0032R IC: 3432A-0032R

This device complies with Part 15 of the FCC Rules and with RSS-210 of Industry Canada. Operation is subject to the following two conditions:

1. This device may not cause harmful interference, and

2. This device must accept any interference received, including interference that may cause undesired operation.

i	NOTE
Changes or modifications not expressly approved by the party responsible for compliance could void the user's authority to operate the equipment. The term "IC:" before the radio certification number only signifies that Industry Canada technical specifications were met.	

### Operation

#### To Unlock the Driver's Door

Press the UNLOCK button once. The driver's door will unlock and the parking lights will come on for 40 seconds.

#### To Unlock the Passenger's Door

Press the UNLOCK button once and press again within 5 seconds. The passenger door will unlock.

#### To Lock Both Doors

Press the LOCK button. The doors will lock and the parking lights will come on for 2 seconds. If the doors are open they will not lock.

i	NOTE
If this system is retrofit on vehicles built before March 2002, doors may lock when open.	

The range of the RKE system should be approximately 30 feet. This will be reduced if it is operated close to other RF sources such as TV/radio transmitters and cell towers.

## Batteries

### To Replace the Battery

1. Remove rear cover from key fob.
2. Remove the battery.
3. Install new battery.
4. Reinstall cover.
5. Synchronize the key fob.

The key fob uses one CR2032, 3V battery. Batteries should last approximately three years, depending on use. Consistently reduced range is an indicator that the battery needs replacement. Batteries are available at most discount, hardware and drug stores.

## Synchronization

The key fob may need to be synchronized to the vehicle when the battery is replaced, or when the key fob has not been used for an extended period time.

### To Synchronize a Key Fob

1. Hold the key fob near the center gauge area (middle of the instrument panel).
2. Press either the lock or unlock button twice within 2 seconds.
  - When the key fob is resynchronized, the doors will lock or unlock.
  - If the fob fails to synchronize, it could be programmed to a different vehicle or could have failed.

See Remote Keyless Entry Troubleshooting on page 5-84, for more information.

1

### GETTING TO YOUR ENGINE

#### Hood Hold Downs

The hood is locked in position by two external latches. These latches serve as hold downs and keep the hood from opening unexpectedly.

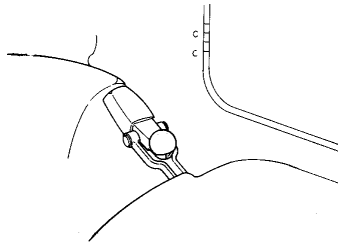

Hood Latch: pull out to release

	<b>CAUTION</b>
If you do not latch your hood securely, it could open during operation and cause vehicle damage. Be sure to latch the hood securely.	

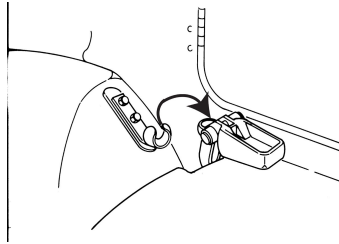

Pull up and over to unlatch

#### Hood Tilt

To open the hood, unlock the hood holddown by unlatching it. Put one hand on the KW emblem, one foot on the bumper, and one foot on the ground. Tilt the hood forward.

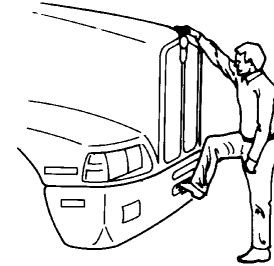

	<b>WARNING!</b>
A hood could hurt someone in the way of its descent. Before lowering the hood, be sure there are no people or objects in the way.	



## Hood Safety Cable

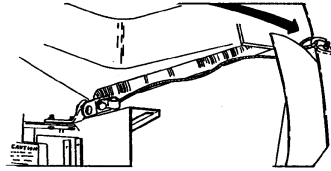
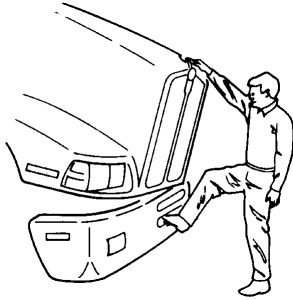

Attach safety cable here

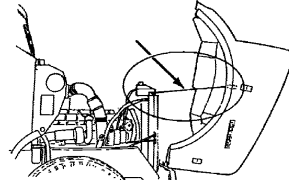

Attached cable



### WARNING!

If the hood falls, anyone under it could be injured. Always attach the safety cable and/or hood stop when the hood is in its open position any time anyone gets under the hood for any reason.



### CAUTION

Before lowering the hood, be sure no objects or people are in the way. Look on both sides of the engine and then yell "HOOD DOWN" prior to closing the hood.



### WARNING!

If the hood is not latched securely, it could open during operation and cause an accident. Be sure the hood is latched securely before moving the vehicle.

## SEATS AND RESTRAINTS

### Introduction

This section covers the operation and safe use of your Kenworth seats. For further information on features and adjustment of the seat, see the manufacturer's Service and Operation Manual included with the vehicle.

### Seat Adjustment

 <b>WARNING!</b>
Do not adjust the driver's seat while the vehicle is moving. The seat could move suddenly and unexpectedly and can cause the driver to lose control of the vehicle. Make all adjustments to the seat while the vehicle is stopped. After adjusting the seat and before driving off, always check to ensure that the seat is firmly latched in position. Failure to comply may result in death, personal injury, equipment or property damage.

 <b>NOTE</b>
After adjusting the seat and before driving off, always check to ensure that the seat is firmly latched in position.

### Standard Driver's Seat

The standard driver's seat can be adjusted forward and rearward as well as up and down. The seat back angle can also be adjusted. These three movements are each controlled by levers located either beneath or at the sides of the seat.

### Driver's Seat with Air Suspension

 <b>WARNING!</b>
Before driving or riding in vehicle, ensure that there is adequate head clearance at maximum upward travel of seat. Injury may occur if head clearance is not adequate. Failure to comply may result in personal injury or death.

### Reclining Seats

- Raise the seat all the way up so that the seat will tilt back and

completely clear objects behind you.

 <b>WARNING!</b>
Do not drive or ride with your seat back in the reclined position. You could be injured by sliding under the seat belts in a collision. Failure to comply may result in personal injury or death.

## Safety Restraint Belts

Safety belts have proven to be the single most effective means available for reducing the potential for either injury or death in motor vehicle accidents. Therefore, read the following instructions and always observe user warnings pertaining to safety belts.

 <b>WARNING!</b>
Do not drive vehicle without your seat belt and your riders belts fastened. Unbelted riders could be thrown into the windshield or other parts of the cab or could be thrown out of the cab. Injuries can be much worse when riders are unbelted. Always fasten your seat belt and be sure anyone riding with you does the same. Failure to comply may result in personal injury or death.

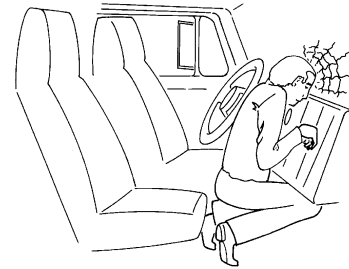

**Unbelted Person in Crash**

Your vehicle may be equipped with a seat belt indicator in the warning light display above the speedometer/tachometer (see "Seat Belt, Fasten" on page 3-43). It will turn on if the seat belt is not fastened and the ignition key is turned on.

# SEATS AND RESTRAINTS

---

1

## Lap/Shoulder Belt

The combination lap-shoulder belt is equipped with a locking mechanism. The system adjusts automatically to a person's size and movements as long as the pull on the belt is slow.

Hard braking or a collision locks the belt. The belt will also lock when driving up or down a steep hill or in a sharp curve.

### To fasten the belt:

1. Grasp the belt tongue.
2. Pull belt in a continuous slow motion across your chest and lap.
3. Insert belt tongue into buckle on inboard side of seat.
4. Push down until the tongue is securely locked with an audible click. Pull belt to check for proper fastening.

- Pull shoulder section to make sure belt fits snugly across the chest.
- The shoulder belt must be positioned over the shoulder, it must never rest against the neck.
- Belts should fit snugly across the pelvis and chest. Make sure any slack is wound up on the retractor.

### To unfasten the belt:

- Push in the release button on the buckle. The belt will spring out of the buckle.
- To release a locked belt, lean back to take the body pressure off of the belt.
- To store a lap-shoulder belt, allow the belt to wind up on the retractor by guiding the belt tongue until the belt comes to a stop.

## Proper Safety Belt Adjustment

Your combination lap-shoulder belt may need adjustment. Adjust safety belts properly.

- The lap belt should be worn as low and tight on the hips as possible. Make sure any slack is taken up by the belt mechanism.
- The shoulder belt should fit snugly across your body. It should be positioned midway over the shoulder (that is next to the door); it should never rest against your neck.

## Safety Restraint Belts

### Lap Belt

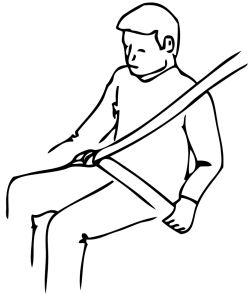

Correct

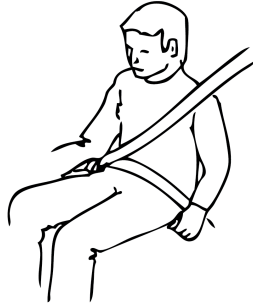

Incorrect (too high on hips)



Correct (over arm)

### Shoulder Belt



Incorrect (under arm)



Incorrect (twisted)

- Be sure, also, that your belt is not too loose. A loose belt could allow you to slide under it in an accident, and that could bring the belt up around your abdomen.
- Ensure that you do not twist the belt in the process of putting it on.

A twisted belt will not work as well to protect you.



### WARNING!

Proper seat belt adjustment and use is important to maximize occupant safety. Failure to wear or adjust the safety belt properly may result in death or personal injury.

## SEATS AND RESTRAINTS

---

1

- You can be injured if your belt is buckled too high. In a crash, it would apply force to your abdomen, not your pelvic bones. This can result in internal injuries.
- Do not drive with your seat belt loose. A too-loose seat belt can allow you to fall too far forward, possibly causing head and neck injuries. You could strike the wheel or the windshield. Adjust your belt so that there is no more than 1 in. (25mm) of slack.



### WARNING!

Do not wear the shoulder part of belt under your arm or otherwise out of position. In a crash your body would move too far forward, increasing the chance of head and neck injury. Also, the belt would apply too much force to the ribs, which are not as strong as your shoulder bones, and could cause you to suffer internal injuries. Wear the shoulder belt over your shoulder (see Safety Restraint Belts on page 1-19). Failure to comply may result in personal injury or death.



### WARNING!

Do not twist the belt in the process of putting it on. A twisted belt will not work as well to protect you. In a crash, the full width of the belt would not be protecting you. A twisted belt could cut into your body and cause injuries. Straighten the belt before buckling it. If you are unable to wear it without twisting it, have your dealer or service person repair it as soon as possible. Failure to comply may result in personal injury or death.

## Tether Belts

Tether belts are installed on suspension seats. They help secure the seat to the floor to restrain it in case of a sudden stop or an accident.

### Fixed Tethers

If your Kenworth has been equipped with fixed length tethers, no manual adjustment is required. The same inspection and replacement guidelines should be used as stated in Safety Restraint System - Inspection on page 5-60.

 <b>WARNING!</b>
Do not remove, modify, or replace the tether belt system with a different tether system. A failed or missing tether belt could allow the seat base to fully extend in the event of an accident. Failure to comply may result in personal injury or death.

 <b>WARNING!</b>
Failure to adjust tether belts properly can cause excessive movement of the seat in an accident. Tether belts should be adjusted so that they are taut when the seat is in its most upward and forward position. Failure to comply may result in personal injury or death.

 <b>WARNING!</b>
Before driving or riding in a vehicle, ensure that there is adequate head clearance at maximum upward travel of seat. Shorten the tether belt as necessary to provide adequate head clearance. Injury or death may occur if head clearance is not adequate.

# SEATS AND RESTRAINTS

1

## Tether Adjustment

- Make sure that the tether belt is attached to the cab floor and seat frame. It should be routed through the buckle on each side.
- Often the attachments are made using a split-type hook. Make sure both halves of the hook are around the anchor bracket.
- To lengthen the tether, turn the buckle to a right angle to the webbing. Then pull the buckle. To shorten the tether, pull on the strap.

## Komfort-Latch® Feature

Your vehicle includes a feature designed to eliminate cinching and provide improved safety and comfort. Cinching is the condition where a belt becomes continually tighter around you during a rough, bouncy ride. The need for this feature increases with rough road conditions, particularly over long distances.

To eliminate cinching, simply activate the Komfort-Latch feature located on the seat belt webbing at the appropriate time:

1. Adjust the seat to its proper driving position.
2. Latch the seat belt.
3. If available, adjust the seat belt height adjuster to a comfortable driving position.

4. While seated appropriately, push the "on" button to engage the Komfort-Latch.
5. Learn forward in the seat until you hear a "click."
6. Return to normal driving position, and the Komfort-Latch maintains the preset amount of tension relief.

To disengage the mechanism:

1. Unbuckle the seat belt
2. Press the "OFF" button of the Komfort-Latch or tug on the shoulder strap.



### WARNING!

Do not set the Komfort-Latch with too much slack. Too much slack may reduce the effectiveness of the seat belt. Failure to comply may result in death or personal injury.



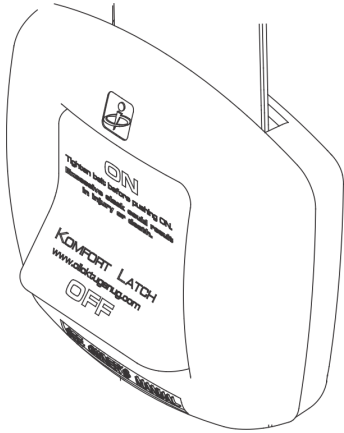

Komfort-Latch®

More information and video tutorials can be found at: [www.clicktugsnug.com](http://www.clicktugsnug.com)

## During Pregnancy

Pregnant women should always wear combination lap/shoulder belts. The lap belt portion must be worn snugly and as low as possible across the pelvis. To avoid pressure on the abdomen, the belt must never pass over the waist. Sometimes pregnant women worry that in a crash the seat belt could hurt the baby. But if a woman wears her belt properly, low over her pelvis, below her abdomen, the belt will not harm the baby, even in a crash. And remember, the best way to keep an unborn baby safe is to keep the mother safe.

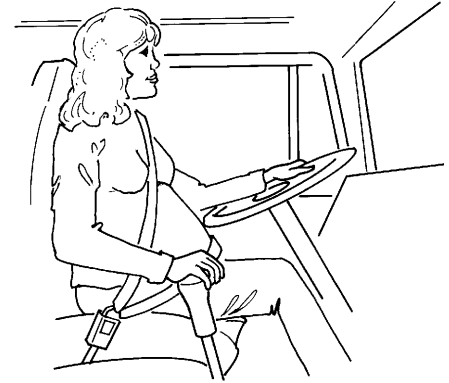

Pregnant Woman with Belt Properly Worn

# SEATS AND RESTRAINTS

---

1

## Belt Damage and Repair

Damaged belts in the cab must be replaced. Belts that have been stretched, cut, or worn out may not protect you in an accident.

If any seat belt is not working properly, see an Authorized Service Center for repair or replacement.

For further information on seat belts and seat belt maintenance, see Safety Restraint System - Inspection on page 5-60.

## Safety Restraint Tips

- Anyone riding in your vehicle should wear a seat belt. A responsible operator sees to it that everyone in the vehicle rides safely and that means with a seat belt.
- Do not wear a belt over rigid or breakable objects in or on your clothing, such as eye glasses, pens, keys, etc., as these may cause injury in an accident.
- Several layers of heavy clothing may interfere with proper positioning of belts and reduce the overall effectiveness of the system.
- Any authorized person sleeping in your vehicle while it is moving should use the bunk restraint.
- Any authorized person sitting in the sleeper area on the sofa bed (if equipped) while it is moving should wear a seat belt.
- A responsible operator sees to it that everyone in the vehicle rides or sleeps safely. The operator is responsible to inform any passengers or co-drivers how to properly use the seat belts and bunk restraint in the vehicle.
- Do not strap in more than one person with each belt.
- Keep seat belt and bunk restraint buckles free of any obstruction that may prevent secure locking.
- Damaged or worn belts in the cab or sleeper, subjected to excessive stretch forces from normal wear, must be replaced. They may not protect you if you have an accident.
- Any belts or restraints that have been subjected to an accident

- should be inspected for any loose (attaching) hardware or damaged buckles.
- If belts show damage to any part of assembly, such as webbing, bindings, buckles or retractors, they must be replaced.
  - Do not allow safety belts (seat or bunk) to become damaged by getting caught in door, bunk or seat hardware, or rubbing against sharp objects.
  - All belts must be kept clean or the retractors may not work properly.
  - Never bleach or dye seat or bunk restraint belts: chemicals can weaken them. Do, however, keep them clean by following the care label on the belts. Let them dry completely before allowing them to retract or be stowed away.
  - Make sure the seat belts and bunk restraint of the unoccupied passenger seat or bunk is fully wound up on its retractor or is stowed, so that the belt or restraint tongue is in its properly stowed position. This reduces the possibility of the tongue becoming a striking object in case of a sudden stop.
  - Do not modify or disassemble the seat belts or bunk restraint in your vehicle. They will not be available to keep you and your passengers safe.
  - If any seat belt or bunk restraint is not working properly, see an authorized dealer for repair or replacement.

# START-UP

## Introduction

The following section covers start-up procedures for getting your Kenworth ready for the road.

## Safe Vehicle Operation

For your safety, as well as those around you, be a responsible driver:

- If you drink, do not drive.
- Do not drive if you are tired, ill, or under emotional stress.

Much has gone into the manufacturing of your Kenworth, including advanced engineering techniques, rigid quality control, and demanding inspections. These manufacturing processes will be enhanced by you, the safe driver, who observes the following:

- knows and understands how to operate the vehicle and all its controls
- maintains the vehicle properly
- uses driving skills wisely

For more information, refer to Department of Transportation Regulation 392.7, which states that interstate commercial motor vehicles are not to be driven unless the driver is sure that certain parts and accessories are in working order.



### **WARNING!**

Do not drive after drinking alcohol or using other substances that may affect the senses, including prescription medications. Your reflexes, perceptions, and judgment can be affected by even a small amount of alcohol or other substances, and can cause a serious or even fatal accident. Failure to comply may result in death, personal injury, or equipment and property damage.

**WARNING!**

The use of alcohol, drugs, and certain medications will seriously impair perception, reactions, and driving ability. These circumstances can substantially increase the risk of an accident. Failure to comply may result in death, personal injury, equipment or property damage.

**WARNING!**

Do not text while driving. Your reflexes, perceptions, and judgment can be affected while texting or using any other form of mobile messaging while driving. Failure to comply may result in death, personal injury, or equipment and property damage.

## Vehicle Loading

Compare your vehicle's load capacity with the total load you are carrying. If adjustments need to be made, make them, do not drive an overloaded vehicle. If you are overloaded or your load has shifted, your vehicle may be unsafe to drive.

**WARNING!**

Do not exceed the specified load rating. Overloading can result in loss of vehicle control, either by causing component failures or by affecting vehicle handling. Exceeding load ratings can also shorten the service life of the vehicle. Failure to comply may result in personal injury or death.

- **The components of your vehicle are designed to provide satisfactory service if the vehicle is not loaded in excess of either the gross vehicle**

**weight rating (GVWR), or the maximum front and rear gross axle weight ratings (GAWRs). (Axle weight ratings are listed on the driver's door edge.)**

The following are some definitions of weight you should know:

**GVWR:** is the Gross Vehicle Weight Rating. This is the **MAXIMUM WEIGHT** your vehicle is allowed to carry, including the weight of the empty vehicle, loading platform, occupants, fuel, and any load. Never exceed the GVWR of your vehicle.

**GCW:** is the actual combined weight, or Gross Combination Weight (GCW), of your vehicle and its load: vehicle, plus trailer(s), plus cargo.

**GAWR:** is the Gross Axle Weight Rating. This is the total weight that one axle is designed to transmit to the

## START-UP

---

1

ground. You will find this number listed on the driver's door edge.

**Load Distribution:** be sure any load you carry is distributed so that no axle has to support more than its GAWR.



### WARNING!

An unevenly distributed load or a load too heavy over one axle can affect the braking and handling of your vehicle, which could result in an accident. Even if your load is under the legal limits, be sure it is distributed evenly. Failure to comply may result in personal injury, death, equipment or property damage.

## Emergency Equipment

It is good practice to carry an emergency equipment kit in your vehicle. One day, if you have a roadside emergency, you will be glad the following items are with you:

- window scraper
- snow brush
- container or bag of sand or salt
- emergency light
- triangles
- small shovel
- first aid kit
- fire extinguisher
- vehicle recovery hitches (see Vehicle Recovery Guidelines on page 2-12 for details).

## Driver's Check List

To keep your Kenworth in top shape and maintain a high level of safety for you, your passengers, and your load, make a thorough inspection every day before you drive. You will save maintenance time later, and the safety checks could help prevent a serious accident. Please remember, too, that Federal Motor Carrier Safety Regulation 392.7 requires a pre-trip inspection and so do commercial trucking companies.

You are not expected to become a professional mechanic. The purpose of your inspections is to find anything that might interfere with the safe and efficient transportation of yourself, any passengers, and your load. If you do find something wrong and cannot fix it yourself, have an authorized Kenworth Dealer or qualified mechanic repair your vehicle right away.

The following operations are to be performed by the driver. Performing these checks and following the maintenance procedures in this manual will help keep your Kenworth running properly.

### Approaching Your Vehicle

- Check the overall appearance and condition. Are windows, mirrors, and lights clean and unobstructed?
- Check beneath the vehicle. Are there signs of fuel, oil, or water leaks?
- Check for damaged, loose, or missing parts. Are there parts showing signs of excessive wear or lack of lubrication? Have a qualified mechanic examine any questionable items and repair them without delay.
- Check your load. Is it secured properly?

### Daily Checks

#### Engine Compartment Checks - Daily

1. Engine Fluid Levels - add more if necessary.
  - Engine oil
  - Coolant (check while engine is cold)
  - Power steering fluid level
2. Engine Belt - check tension and condition of belts. This is important to ensure proper air compressor and engine operation.
  - Measure the belt tension at the longest span of the belt. See Accessory Drive Belts on page 5-95 for further information on checking belt tension.

	<b>NOTE</b>
Deflection should be one belt thickness for each foot distance between the pulley centers.	

- If breaks or tears are found, the belt should be replaced before operating the vehicle.
- 3. Fuel Filter/Water Separator Draining - check and drain. Depending on the fuel storage facility, more frequent draining may be required.
- 4. Windshield washer reservoir fluid level - fill if necessary.
- 5. Battery Cables - check the condition of the battery and alternator cables for signs of chafing or rubbing. Make sure that all clamps (straps) holding the cables are present and in good working order.

- 6. Hood closed before entering cab. Is it latched properly?

### Chassis and Cab Checks - Daily

Before entering the cab and operating the vehicle, check the following equipment for proper maintenance:

- 1. Lights - do headlights, turn signals, emergency flashers, and exterior lamps function and are they clean and adjusted properly?
- 2. Windows and Mirrors - are they clean and adjusted properly?
- 3. Tires and Wheels - are they inflated properly? Are all wheel cap nuts in place and torqued properly - tighten if necessary. Check front wheel bearing oil levels. Inspect all tires and wheels for damage - correct if found.
- 4. Suspension - check for loose or missing fasteners. Check damage

to springs or other suspension parts.

- 5. Brake Components - check lines, linkages, chambers, parking and service brake operation.
- 6. Air System - are there leaks?
  - Air Tanks - drain water from all air tanks. Make sure the drain cocks are closed. This procedure is also required for air suspension tanks equipped with automatic drain valves.
  - For further details See Using the Brake System on page 4-17.
- 7. Steps and Handholds - check for worn surfaces and loose or missing fasteners.
- 8. Fluid Tanks - check underneath the vehicle for signs of fluid leaks. If any are found, correct before operating the vehicle.



9. Fuel Tank Caps - are they secure?

 <b>WARNING!</b>
<p>Do not remove a fuel tank cap near an open flame. Diesel fuel in the presence of an ignition source (such as a cigarette) could cause an explosion. A mixture of gasoline or alcohol with diesel fuel increases this risk of explosion. Use only the fuel and/or additives recommended for your engine. Failure to comply may result in personal injury, death, equipment or property damage. See Refueling on page 4-80, for more information.</p>

10. Trailer Connections - are they secure and the lines clear? If they are not being used, are they stored properly?
- Is the trailer spare wheel secure and inflated?
  - Is the landing gear up and the handle secured?

11. Check the fifth wheel. Is the kingpin locked?
- Is the sliding fifth wheel locked?

**Cab Interior - Daily**

1. Seat - adjust the seat for easy reach of controls.
2. Seat Belts - fasten and adjust safety restraint belts.
3. Steering Column - adjust for easy reach.
4. Mirrors - check and readjust mirrors if necessary.

5. Lights - turn ignition key to the ON position and check for warning lights and buzzer. Check operation of turn signals and emergency lights.
6. Instruments - check all instruments.
7. Windshield - check operation of windshield wipers and washers.
8. Horn - check operation of horn.
9. Fuel - check fuel. Is there enough fuel?
10. Diesel Exhaust Fluid (DEF) - check level. Is there enough fluid?

i	NOTE
<p>The above items (Engine Compartment, Chassis and Cab, and Prestart Checks) should be checked daily, as a minimum. They are in addition to, not in place of Federal Motor Carrier Safety Regulations. These regulations may be purchased by writing to: Superintendent of Documents U.S. Government Printing Office Washington, DC 20402</p>	

## Weekly Operations

1. Battery - check battery and terminals.
2. Wheel Cap Nuts - are they all in place and torqued properly - tighten if necessary. See Wheel Cap Nut Torque on page 5-133.
3. Other Controls and Wiring - check for condition and adjustment
4. Steering Components - check pitman arm, draglink, and power steering hoses, etc., for loose, broken, or missing parts.
5. Other Engine Compartment Checks
  - Check condition and fastening of engine belt, hoses, clamps, and radiator.
  - Check the air cleaner, muffler, and exhaust pipes. Are they tight and secure?

- After Engine Warm-up
  - Automatic Transmission - check fluid level in the automatic transmission oil (if equipped).

**WHAT TO DO IF...**

You Need Roadside Assistance . . . . . 2-3  
Low Air Alarm Turns On . . . . . 2-3  
Stop Engine Lamp Turns On . . . . . 2-4  
Engine Oil Pressure Lamp Turns On. . . . . 2-4  
Check Engine Lamp Turns On . . . . . 2-5  
Engine is Overheating . . . . . 2-5  
Fuse or Relay Blows . . . . . 2-7

**JUMP STARTING VEHICLES**

Introduction . . . . . 2-9

**VEHICLE RECOVERY AND SPRING BRAKES**

Introduction . . . . . 2-12  
Vehicle Recovery Instructions . . . . . 2-12  
Recovery Rigging . . . . . 2-14  
Returning Vehicle to Service . . . . . 2-14  
Spring Brakes - Manual Release . . . . . 2-15  
Freeing the Vehicle from Sand, Mud, Snow and Ice 2-17



## WHAT TO DO IF...

### You Need Roadside Assistance



Call toll-FREE 1-800-KW-ASSIST (1-800-592-7747) to talk to someone at the PACCAR Customer Center.

- Open 24-7-365 days a year
- They can help you get roadside assistance.
- They have a custom mapping system which locates Kenworth & Peterbilt Dealers and Independent Service Providers (ISPs) near you and lists types of services offered, hours of operation and contact information.

- They can assist with jump and pull starts, tires, trailers, fines and permits, chains, towing, hazardous clean-up, out of fuel (roadside), mechanical repairs and preventive maintenance services.
- They have bilingual agents and access to a translation service to ensure quality assistance for customers who speak any language.
- They can't answer your warranty questions but can get you in contact with a Kenworth dealer who can.
- The PACCAR Customer Center service is FREE even if you don't drive a Kenworth.

### Low Air Alarm Turns On

1. Slow down carefully.
2. Move a safe distance off the road and stop.
3. Place the transmission in neutral (park with automatic transmissions, if equipped) and set the parking brake. (Refer to Parking Brake Valve on page 3-94 and OPERATING THE TRANSMISSION on page 4-70, for transmission shifting and parking brake information.)
4. Turn OFF the engine.
5. Turn ON the emergency flasher and use other warning devices to alert other motorists.



### WARNING!

If the air pressure falls below 60 psi (414 kPa) the spring brakes may stop the vehicle abruptly, which could cause an accident resulting in personal injury or death. Observe the red warning lamps on the gauges. If one comes on, do not continue to drive the vehicle until it has been properly repaired or serviced.

If the light and alarm do not turn off at startup, do not try to drive the vehicle until the problem is found and fixed. (Refer to USING THE BRAKE SYSTEM on page 4-17, for more brake information.)

## Stop Engine Lamp Turns On



### WARNING!

This should be considered an emergency. You should stop the vehicle as safely as possible and turn OFF the ignition. The vehicle must be serviced and the problem corrected before driving again. Failure to do so may cause severe engine or DPF damage, or cause an accident which may result in personal injury or death

If the Stop Engine warning lamp illuminates, it means you have a serious engine system problem.

## Engine Oil Pressure Lamp Turns On



1. Slow down carefully.
2. Move a safe distance off the road and stop.
3. Place the transmission in park and set the parking brake. (See Parking Brake Valve on page 3-94 and OPERATING THE TRANSMISSION on page 4-70, for transmission shifting and parking brake information.)
4. Turn OFF the engine.
5. Turn ON the emergency flasher and use other warning devices to alert other motorists.
6. Wait a few minutes to allow oil to drain into the engine oil pan, and then check the oil level. (See Oil

Level Check on page 5-91, for details on checking oil level.)

7. Add oil if necessary. If the problem persists, contact an authorized Kenworth dealer as soon as possible.



#### CAUTION

Continuing to operate your vehicle with insufficient oil pressure may cause severe engine damage or cause an accident which may result in equipment or property damage.

It is important to maintain oil pressure within acceptable limits. If oil pressure drops below the minimum psi a Red Warning Lamp on the oil pressure gauge and the Stop Engine Lamp will come ON.

## Check Engine Lamp Turns On



Vehicle should be serviced to correct the problem but the situation should not be considered an emergency. The vehicle can still be safely driven.

## Engine is Overheating

1. Reduce engine speed and safely stop the vehicle. When stopped, place the transmission in Neutral and set the parking brake. (See Parking Brake Valve on page 3-94 and OPERATING THE TRANSMISSION on page 4-70, for transmission shifting and parking brake information.) Keep the engine running.
2. Check to ensure the Oil Pressure Gauge reads normal. (See Engine Oil Pressure Gauge, on page 3-59, for further information.)
3. Make sure the engine fan is turning by switching the Engine Fan Switch from AUTO to MAN (Manual).
4. Increase the engine speed to about one-half of full operating speed, or 1,100 to 1,200 rpm, maximum.

## WHAT TO DO IF...

2

5. Return the engine speed to normal idle after 2 or 3 minutes.
6. Monitor the engine temperature. After the temperature returns to normal, allow the engine to idle 3 to 5 minutes before shutting it off. This allows the engine to cool gradually and uniformly.
7. If overheating came from severe operating conditions, the temperature should have cooled by this time. If it has not, stop the engine and let it cool before checking to see if the coolant is low.
  - Wait until the coolant temperature is below 122° F (50° C).
  - Protect face, hands, and arms by covering the cap with a large, thick rag to protect against escaping fluid and steam.

- Carefully and slowly turn the cap one-quarter of a turn or until it reaches the first stop—allowing excess pressure to escape—push down and turn for final removal.

See Topping Up on page 5-65, for instructions on checking and filling the coolant expansion tank.



### WARNING!

Do not remove the radiator fill cap while the engine is hot. Scalding steam and fluid under pressure may escape. You could be badly burned. Failure to comply may result in personal injury or death.



### WARNING!

To reduce the chance of death, personal injury, fire and/or vehicle damage from overheated engines, never leave the engine idling without an alert driver present. If the engine should overheat, as indicated by the engine coolant temperature light, immediate action is required to correct the condition. Continued unattended operation of the engine, even for a short time, may result in serious engine damage or a fire. Failure to comply may result in personal injury, death, equipment or property damage.



## Fuse or Relay Blows

Fuses, circuit breakers, and relays are located in the Power Distribution Box to the left of the steering column behind the clutch pedal. See Power Distribution Box on page 5-73.

Additional fuses for the alternator, engine electronics and trailer battery charge circuit may be located in the Power Distribution Center (PDC) inside the battery box and/ or on the engine side of the cab firewall. See Power Distribution Center (PDC) on page 5-71.



### WARNING!

Do not replace a fuse with a fuse of a higher rating. Doing so may damage the electrical system and cause a fire. Failure to comply may result in personal injury, death, equipment or property damage.



### CAUTION

Before replacing a fuse, turn OFF all lights and accessories and remove the ignition key to avoid damaging the electrical system.



### CAUTION

Never patch fuses with tin foil or wire. This may cause serious damage elsewhere in the electrical circuit, and it may cause a fire.



### CAUTION

If a circuit keeps blowing fuses, have the electrical system inspected for a short circuit or overload by an authorized Kenworth dealer as soon as possible. Failure to do so could cause serious damage to the electrical system and/or vehicle.



### NOTE

If a fuse of the same rating is not available, a fuse of a lower rating may be temporarily substituted. You can also use a fuse from a circuit you can do temporarily without (for example an accessory circuit or radio).

All the electrical circuits have fuses to protect them from a short circuit or overload. If something electrical on your chassis stops working, the first thing you should check for is a blown fuse.

1. Turn OFF all lights and accessories and remove the ignition key to avoid damaging the electrical system.
2. Determine from the chart on the fuse panel which fuse controls that component.
3. Remove that fuse and see if it is blown.

## WHAT TO DO IF...

---

2

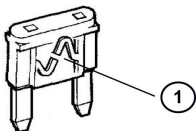

1 Blown

If it is blown, replace it with a fuse of the same rating.



### CAUTION

When replacing a failed circuit breaker, always use an approved circuit breaker with a current rating equal to or less than the circuit breaker being replaced. Only use the approved Type II modified reset circuit breakers. NEVER use a Type I (automatic reset) or Type III (manual reset) circuit breaker. A fuse with a current rating equal to or less than the circuit breaker being replaced can also be used.

## JUMP STARTING VEHICLES

### Introduction

Because of the various battery installations and electrical system options, Kenworth does not recommend that you attempt to jump start your vehicle. If you have a battery problem, it is best to contact a Kenworth Dealer or a reputable towing service.

However, if your battery is discharged (dead), you may be able to start it by using energy from a good battery in another vehicle. This is termed jump starting. Be sure to follow the precautions and instructions below.



#### WARNING!

Batteries contain acid that can burn and gasses that can explode. Ignoring safety procedures may result in personal injury, death, equipment or property damage.



#### WARNING!

Never jump start a battery near fire, flames, or electrical sparks. Batteries generate explosive gases that could explode. Keep sparks, flame, and lighted cigarettes away from batteries. Failure to comply may result in personal injury, death, equipment or property damage.



#### WARNING!

Never remove or tamper with battery caps. Ignoring this could allow battery acid to contact eyes, skin, fabrics, or painted surfaces. Failure to comply may result in personal injury, death, equipment or property damage.

- **Be careful that metal tools (or any metal in contact with the positive terminal) do not contact the positive battery terminal and any other metal on the vehicle at the same time. Remove metal jewelry and avoid leaning over the battery.**
- **If metal jewelry or other metal comes in contact with electrical circuits, a short circuit may occur causing you to be injured, as well as electrical system failure and damage to the vehicle.**

# JUMP STARTING VEHICLES

2

## To Jump Start Your Vehicle

 <b>WARNING!</b>
The voltage of the booster battery must have a 12 volt rating and the capacity of the booster battery should not be lower than that of the discharged battery. Use of batteries of different voltage or substantially different capacity rating may cause an explosion. Failure to comply may result in personal injury, death, equipment or property damage.

 <b>CAUTION</b>
Applying a higher voltage booster battery will cause expensive damage to sensitive electronic components, such as relays, and the radio. Failure to comply may result in equipment damage.

- **Improper hook-up of jumper cables or not following these procedures can damage the alternator or cause serious damage to both vehicles.**

 <b>WARNING!</b>
To avoid personal injury and damage to the vehicle, heed all warnings and instructions of the jumper cable manufacturer.

- **The jumper cables must be long enough so that the vehicles do not touch.**

## Preparing the vehicles:

1. Position the two vehicles together, but do not allow them to touch.
2. Turn OFF all lights, heater, radio, and any other accessory on both vehicles.
3. Set the parking brakes: pull out the Yellow button located on the dash.
4. Shift the transmission into park position or neutral for manual transmissions. (See OPERATING THE TRANSMISSION on page 4-70 and Parking Brake Valve on page 3-94, for transmission shifting and parking brake information.)
5. If either vehicle is equipped with battery disconnects ensure they are in the "OFF" position prior to connecting the two vehicles.

### Connect the batteries:

1. Attach one end of a jumper cable to the **positive (+)** terminal of the discharged (dead) battery. This will have a large **red +** or **P** on the battery case, post, or clamp.
2. Attach the other end of the same cable to the **positive (+)** terminal of the good (booster) battery.
3. Attach the remaining jumper cable **FIRST** to the **negative (-)** terminal (**black or N**) of the good battery.
4. Attach the other end of the negative cable to a bare metal part not bolted to the engine block.  
**IMPORTANT: Always connect positive (+) to positive (+) and negative (-) to negative (-).**
5. If either vehicle is equipped with battery disconnects, ensure that they are in the "**ON**" position.
6. Start the engine:

- Start the vehicle that has the good battery first. Let it run for 5 minutes.
- Then start the vehicle that has the discharged (dead) battery. If the engine fails to start, do not continue to crank the starter but contact the nearest authorized Kenworth Dealer.

### Remove jumper cables:



#### **WARNING!**

When disconnecting jumper cables, make sure they do not get caught in any moving parts in the engine compartment. You could be injured.

- Reverse the above procedure exactly when removing the jumper cables. With engine running, disconnect jumper cables from both vehicles in the exact reverse order (Steps 4-1), making sure to first remove the negative cable from the vehicle with the discharged battery.

# VEHICLE RECOVERY AND SPRING BRAKES

## VEHICLE RECOVERY AND SPRING BRAKES

2

### Introduction

Your Kenworth may be equipped with a Recovery Device(s) designed for short distance recovery purposes only. Use only the original Kenworth recovery device(s) and the instructions below. If your vehicle does not have the proper device contact your authorized Kenworth Dealer.

### Vehicle Recovery Instructions

Refer to the instructions below when towing your vehicle:

- Use proper towing equipment to prevent damage to the vehicle.

 CAUTION
Connect only to the Recovery Device(s), as described on the following pages. Do not attach to bumpers or brackets. Use only equipment designed for this purpose. Connections to other structural parts could damage the vehicle.

 CAUTION
Remove the driveline and axle shafts or lift the driving wheels off the ground before towing the vehicle. See Driver Controlled Main Differential Lock on page 4-60. All lubricating and clutch application oil pressure is provided by an engine-driven pump, which will not work when the engine is stopped. You could seriously damage your vehicle by towing it with the driveline connected and the drive wheels on the ground.



### CAUTION

When vehicles are towed, either by wrecker or piggy-back, the lubricant in the top front of the drive axle will drain to the rear. This will leave the top components dry. The resulting friction may seriously damage them. Always remove the main driveshaft and axle shafts before towing your vehicle.

- See the following references:
  - Recovery Rigging on page 2-14.
  - Driver Controlled Main Differential Lock on page 4-60.
- Use a safety chain system.
- Disconnect driveline.
- Follow state/provincial and local laws that apply to vehicles in tow.

- Do not tow vehicles at speeds in excess of 55 mph (90 km/h).



### NOTE

For additional information concerning heavy duty truck recovery, see Technology & Maintenance Council (TMC)

- Recommended Practice #602–A — "Front Towing Devices For Trucks and Tractors."
- Recommended Practice #602–B — "Recovery Attachment Points For Trucks, Tractors, and Combination Vehicles"
- Recommended Practice #626 — "Heavy Duty Truck Towing Procedures."

Copies of these can be obtained from the following address:

Technology & Maintenance Council  
950 N. Glebe Road  
(703) 838-1763  
Arlington, VA 22203  
Email: [tmc@trucking.org](mailto:tmc@trucking.org)  
[www.trucking.org](http://www.trucking.org)

## VEHICLE RECOVERY AND SPRING BRAKES

### Recovery Rigging

To connect to the Kenworth, follow the suggested rigging methods below.

- Use a double chain or cable setup that distributes the load equally

to both hitches. See 1 or 2 in Recovery Rigging.

- Never loop a single chain or cable through both hitches (3).
- Use a spreader or equalizer bar to distribute the load on both hitches (1).

- If no spreader bar is available, connect the main tow chain or cable no closer than 6 ft. from the vehicle (2).

2

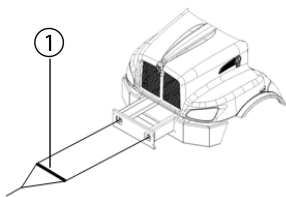

1. Spreader Bar or Equalizer  
**Preferred**

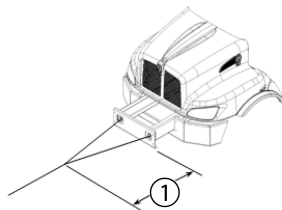

1. Minimum 6 FT.  
**Acceptable**

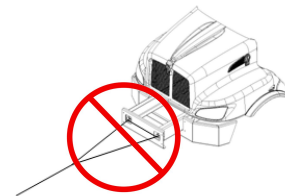

**NEVER USE SINGLE CHAIN OR CABLE  
LOOPEd THROUGH TOW DEVICES**

### Returning Vehicle to Service

Your vehicle may have lost lubricant while being towed. To prevent damage, check the oil level and add oil if necessary.

After adding the specified type and amount of lubricant, drive the vehicle. It should be unloaded. Drive 1 to 2 miles (1.5 to 3 km) at a speed lower than 25 mph (40 km/h). This

will thoroughly circulate the lubricant through the assembly.



## Spring Brakes - Manual Release

In order to tow a vehicle, if there is insufficient air to release the parking brake, the spring brakes can be manually released.

 <b>WARNING!</b>
Do not drive vehicle with malfunctioning brakes. If one of the brake circuits should become inoperative, braking distances will increase substantially and handling characteristics while braking will be affected. You could lose control of your vehicle or cause an accident. Have it towed to the nearest dealer or qualified repair facility for repair. Failure to comply may result in personal injury, death, equipment or property damage.

You may sometimes have to release your vehicle's spring brakes by hand.

This could happen if the system air pressure does not reach operating pressure because your engine or compressor is not working properly. You will have to release the spring brakes at the spring brake chambers.

 <b>WARNING!</b>
Do not disassemble a spring brake chamber. These chambers contain a powerful spring that is compressed. Sudden release of this spring may result in personal injury or death.

 <b>WARNING!</b>
<b>Do not operate a vehicle when the spring brakes have been manually released. Driving a vehicle after its spring brakes are manually released is extremely dangerous. The brakes may not function. Failure to comply may result in personal injury, death, equipment or property damage.</b>

 <b>WARNING!</b>
<b>Releasing the spring brakes on an unsecured vehicle could lead to an accident. The vehicle could roll, which may result in personal injury, death, equipment or property damage. Always secure the vehicle with wheel chocks, chains, or other safe means to prevent rolling before manually releasing the spring brakes.</b>

## VEHICLE RECOVERY AND SPRING BRAKES

2

To move a vehicle immobilized by the spring brakes due to loss of air pressure in the brake system, perform the following procedure:



1. Remove the cap from the spring chamber.

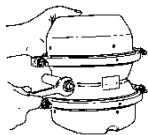

2. Remove the release stud assembly from the side pocket, and remove the release nut and washer from the release stud.

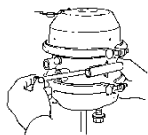

3. Slide out the release stud.

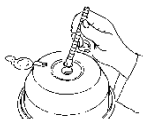

4. Insert the release stud through the opening in the spring chamber where the cap was removed. Insert it into the pressure plate. Turn the release stud 1/4 turn clockwise in the pressure plate. This secures the cross pin into the cross pin area of the pressure plate and locks it into the manual release position.

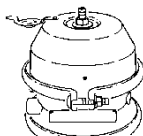

5. Assemble the release stud washer and nut on the release stud.

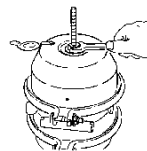

6. With a wrench, turn the release stud assembly nut until the compression spring is 90-95 percent caged. While doing this, check to make sure the push rod (adapter push rod or service push rod) is retracting. Do not over-torque the release stud assembly. (S-Cam type maximum: 50 lb-ft, Wedge type maximum: 30 lb-ft). The spring brake is now mechanically released.

### Freeing the Vehicle from Sand, Mud, Snow and Ice

If the vehicle gets stuck in sand, mud, snow, or ice:

- Move the gearshift lever or selector from First to Reverse.
- Apply light pressure on the accelerator pedal while the transmission is in gear.
- Remove your foot from the accelerator while shifting.
- Do not race the engine.
- For best traction and safety, avoid spinning the wheels.



#### WARNING!

Do not spin the wheels faster than 35 mph (55 km/h). Spinning a tire at speedometer readings faster than 35 mph (55 km/h) can be dangerous. Tires can explode from spinning too fast. Under some conditions, a tire may be spinning at a speed twice that shown on the speedometer. Any resulting tire explosion could cause injury or death to a bystander or passenger, as well as extensive vehicle damage: including tire, transmission and/or rear axle malfunction.

Comply with the following instructions to avoid transmission damage:

- Always start vehicle in motion with the shift lever in first gear.
- Be sure that transmission is fully engaged in gear before releasing the clutch pedal (manual only).
- Do not shift into reverse while the vehicle is moving.
- Do not permit the vehicle to be towed for long distances without removing the driveshaft.

# VEHICLE RECOVERY AND SPRING BRAKES

---

## Tire Chains

If you need tire chains, install them on both sides of the driving axle.

2



### CAUTION

Chains on the tires of only one tandem axle can damage the driveline U-joints and the interaxle differential. Repairs could be costly and time-consuming. Failure to comply may result in equipment damage.

**ACCESSORIES**

Introduction . . . . . 3-5  
Radio (Option) . . . . . 3-6  
Cigarette Lighter and Ashtray (Option) . . . . . 3-6  
Clock . . . . . 3-7  
Cab Storage . . . . . 3-7

**HEATING AND AIR CONDITIONING**

Introduction . . . . . 3-9  
Precautions . . . . . 3-10  
Cab Controls . . . . . 3-13

**AUDIBLE ALERTS**

Introduction . . . . . 3-17

**INDICATORS**

Introduction . . . . . 3-24

**GAUGES AND DISPLAYS**

Introduction . . . . . 3-47

**MULTI-FUNCTION DISPLAY**

Introduction . . . . . 3-68  
Alarms, Warning Tones and Visual Indicator Lights 3-68  
Warning and Information Alert Screens . . . . . 3-69  
Wingman® ACB Warning Tone / Alert Screens . . 3-73  
Multi-Function Display . . . . . 3-75

**SWITCHES**

Introduction . . . . . 3-86  
Dash Switches . . . . . 3-87

**STEERING COLUMN**

Introduction . . . . . 3-103  
Turn Signal/High Beam Switch . . . . . 3-103  
Windshield Wipers/Washer. . . . . 3-105  
Trailer Brake Hand Valve. . . . . 3-107  
Stop/Turn Signal Lamp Operation . . . . . 3-107  
Adjustable Tilt/Telescoping Column . . . . . 3-108  
Horn . . . . . 3-109

SmartWheel Multiplex Control System . . . . . 3-110

**MIRRORS**

Introduction . . . . . 3-115  
Power Mirror Switch . . . . . 3-115  
Mirror Heat Button . . . . . 3-117





# ACCESSORIES

## Introduction

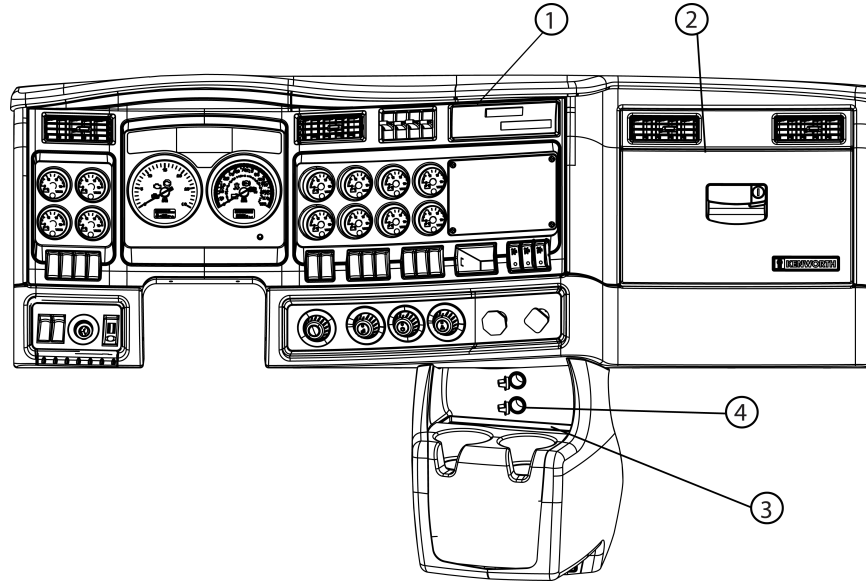

- 1. Radio
- 2. Glove Box

- 3. Ashtray (Option)
- 4. Cigarette Lighter (Option)

## ACCESSORIES

### Radio (Option)

As an option, your vehicle has either an AM/FM Stereo Receiver or AM/FM Stereo with CD.

For instructions on how to operate your particular radio, see the manufacturer's Radio Operating Instructions.

### Cigarette Lighter and Ashtray (Option)



#### NOTE

The cigarette lighter will operate with the ignition key in either the OFF, ACC (accessory), or ON position.

To operate, push in on the knob end of the lighter. After a few moments, the lighter will automatically pop out, glowing hot and ready to use. After use, insert the lighter back into the socket without pushing all the way in.

The socket of the cigarette lighter may be used to operate 12 volt, 15 ampere appliances, such as a hand spotlight or small vacuum cleaner.



#### WARNING!

Do not place paper or other combustible substances in an ashtray, it could cause a fire. Keep all burnable materials, besides smoking materials, out of the ashtray. Failure to comply may result in personal injury, death, equipment or property damage.



#### WARNING!

Do not exceed the voltage/ampere capacity of the cigarette lighter. It could result in a fire. Follow all warnings and instructions in the operator's manual for the appliance you are using. Failure to comply may result in personal injury, death, equipment or property damage.

## Clock Analog Clock

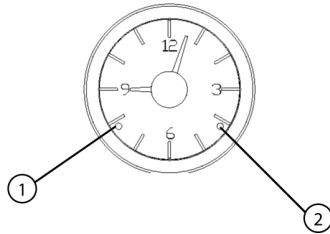

- 1 Depress For Counter Clockwise Rotation
- 2 Depress For Clockwise Rotation

- Depress right hand button to rotate clock hands clockwise.
- Depress left hand button to rotate clock hands counter clockwise.
- Continue to depress buttons for faster movement.

## Cab Storage

### Glove Box

A glove box is provided to store important documents, the vehicle literature set (including this Operator's Manual) and other related materials.

 <b>WARNING!</b>
<p>Do not drive with the glove box open, it can be dangerous. In an accident or sudden stop, you or a passenger could be thrown against the cover and be injured. To reduce the risk of personal injury during an accident or sudden stop, keep the glove box closed when the vehicle is in motion.</p>

### Ashtray

To open, pull on the upper side of the panel. To close, push against the panel.

 <b>WARNING!</b>
<p>Do not place paper or other combustible substances in an ashtray, it could cause a fire. Keep all flammable materials, besides smoking materials, out of the ashtray. Failure to comply may result in personal injury, death, equipment or property damage.</p>

# ACCESSORIES

---

## Interior Compartments

You can choose from a variety of interior storage options to store your personal supplies or small tools:

- center console
- map pocket
- overhead storage compartments
- records holder, behind seat



### WARNING!

Do not carry loose objects in your cab, it can be dangerous. In a sudden stop, or even going over a bump in the road, they could fly through the air and strike you or a passenger. You could be injured or even killed. Secure all loose objects in the cab before moving the vehicle. Carry any heavy objects such as luggage in the exterior storage compartment and close it securely.

## Appliances

If your Kenworth is equipped with a television, or other appliance, be sure they are compatible with your vehicle's electrical system. And secure them in the cab so they cannot come loose in a sudden stop.



### WARNING!

In a sudden stop or collision a heavy object in your cab could strike you or anyone with you. You could be injured or even killed. Secure any appliance (such as a radio, or TV) you add to your cab.

# HEATING AND AIR CONDITIONING

## Introduction

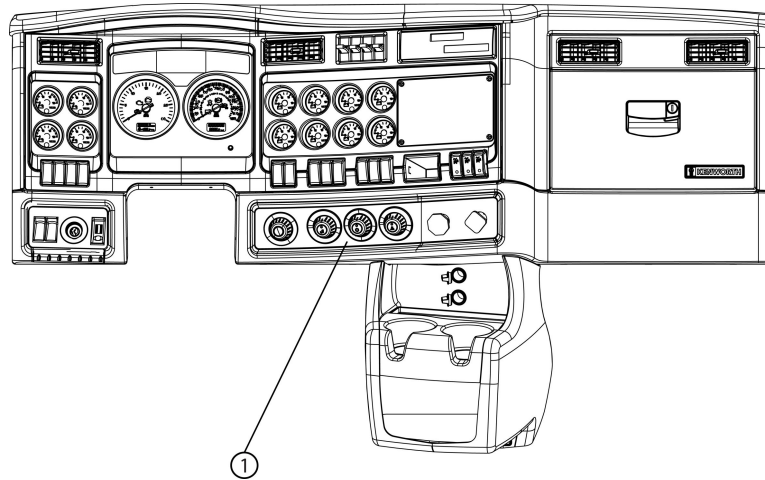

1. Heating and Air Conditioning Controls

## HEATING AND AIR CONDITIONING

---

The cab heater and A/C controls are located together in the center of the dash just to the right of the steering column.

### Precautions



#### WARNING!

Do not drive with visibility reduced by fog, condensation, or frost on the windshield. Your view may be obscured, which may result in personal injury, death, equipment or property damage. For clear visibility and safe driving it is extremely important for you to follow the instructions pertaining to the function and use of the ventilation/heating and defogging/defrosting system. If in doubt, consult your dealer. Maximum heating output and fast defrosting can be obtained only after the engine has reached operating temperature.



#### WARNING!

The air conditioning system is under pressure. If not serviced properly, it could explode and may result in personal injury, death or property damage to your vehicle. Any servicing that requires depressurizing and recharging the air conditioning system must be conducted by a qualified technician with the right facilities to do the job.





#### WARNING!

Excessive heat may cause the pressurized components of the air conditioning system to explode. Never weld, solder, steam clean, or use a blow torch near any part of the air conditioning system. Failure to comply may result in personal injury, death, equipment or property damage.

- **If a refrigerant leak develops in the presence of excessive heat or an open flame, hazardous gases may be generated. These gases may cause unconsciousness or death. If you become aware of a refrigerant leak on your vehicle have your system serviced immediately and observe the following precautions:**
  - **Stay away from the hot engine until the exhaust manifold has cooled.**
  - **Do not permit any open flame in the area. Even a match or a cigarette lighter may generate a hazardous quantity of poisonous gas.**
  - **Do not smoke in the area. Inhaling gaseous refrigerant through a cigarette may cause violent illness.**

 <b>WARNING!</b>
Exhaust fumes from the engine contain carbon monoxide, a colorless and odorless gas. Do not breathe the engine exhaust gas. A poorly maintained, damaged or corroded exhaust system can allow carbon monoxide to enter the cab. Entry of carbon monoxide into the cab is also possible from other vehicles nearby. Failure to properly maintain your vehicle could cause carbon monoxide to enter the cab, resulting in illness or death.

 <b>WARNING!</b>
Never idle your vehicle for prolonged periods of time if you sense that exhaust fumes are entering the cab. Investigate the cause of the fumes and correct it as soon as possible. If the vehicle must be driven under these conditions, drive only with the windows open. Failure to repair the source of the exhaust fumes may result in personal injury, death, equipment or property damage.

 <b>NOTE</b>
Keep the engine exhaust system and the vehicles cab ventilation system properly maintained.

It is recommended that the vehicles exhaust system and cab/sleeper be inspected:

- By a competent technician every 15,000 miles

# HEATING AND AIR CONDITIONING

- Whenever a change is noticed in the sound of the exhaust system
- Whenever the exhaust system, underbody, or cab or sleeper is damaged

**i** NOTE

To allow for proper operation of the vehicle ventilation system, keep the inlet grille at the base of the windshield clear of snow, ice, leaves and other obstructions at all times.

**⚠** CAUTION

Do not stay in the vehicle with the engine running or idling for more than 10 minutes with the vehicle's Heater and A/C ventilation system in RECIRC or at LOW FAN SPEED. Even with the ventilation system on, running the engine while parked or stopped for prolonged periods of time is not recommended.

When idling for short periods of time:

- Set the heating or cooling system to Heat or A/C
- Set the fan to Medium or High speed
- Set the controls to FRESH AIR



**i** NOTE

If you are required to idle your vehicle for long periods of time, install an auxiliary heater or automatic idle control. These auxiliary devices can reduce fuel consumption and save you money.

**i** NOTE

If you are parked next to idling vehicles, move your vehicle or do not stay in your vehicle for prolonged periods of time.



## Cab Controls

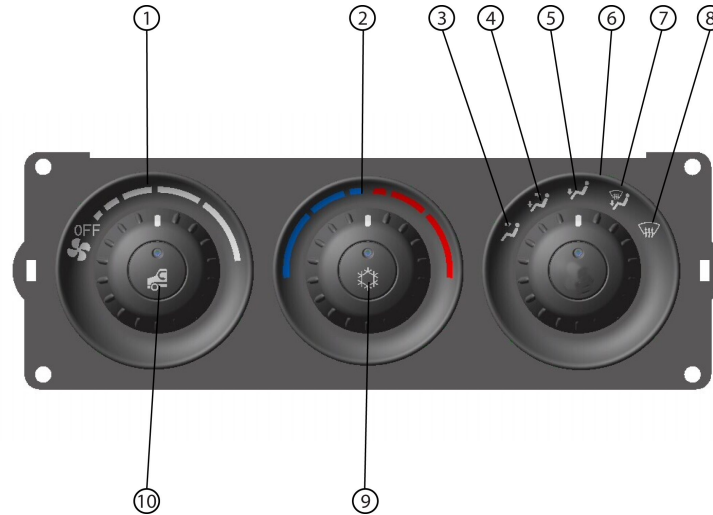

- |                             |                              |
|-----------------------------|------------------------------|
| 1. Fan Control Dial         | 8. Defrost                   |
| 2. Temperature Control Dial | 9. Air Conditioner Enable    |
| 3. Dash                     | 10. Fresh Air / Recirculate, |
| 4. Dash & Floor             | Amber Indicator Light (On)   |
| 5. Floor                    |                              |
| 6. Air Flow Control Dial    |                              |
| 7. Floor & Defrost          |                              |

# HEATING AND AIR CONDITIONING

3

## What Each Control Does



### Fan Control Dial

Turning this dial clockwise from the OFF position turns the fan ON and increases the fan speed.

### Air Flow Control Dial

This dial directs the air flow through 5 primary sets of vents:



### Dash Vents



### Dash and Floor Vents



### Floor Vents



### Floor and \*Defrost Vents



### \*Defrost Vents

\*Fresh air and air conditioning are automatically turned ON. As the dial is turned away from a primary position, the system directs an increasing amount of air flow towards the next primary position.

## Temperature Control Dial

Turn this dial clockwise for heat, counterclockwise for cool.



### Air Conditioner Switch

This switch turns the air conditioner On and Off.



### NOTE

Fan Control Dial must also be in the ON position for A/C to be on.



### Fresh Air/Recirculation Switch

This switch controls the source of the air flowing into the heater and air conditioner unit



**Fresh Air mode** = Air comes from outside the cab.



**Recirculation mode** = Air comes from inside the cab.

## How to Use The System

The engine must be running for the heater and air conditioner to generate hot and cold air.

### To Cool

There are 2 ways to cool:

- a) using cool outside air
- b) using air conditioning

## a) Outside air is cooler than the inside air:

1.) Push the Fresh Air/Recirculation Switch

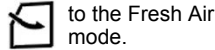

2.) Turn ON the Fan Control Dial

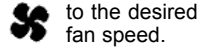

3.) Turn the Air Flow Control Dial

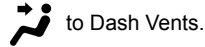

## b) To cool using air conditioning:

1.) Turn ON the Air Conditioning Switch.



2.) Push the Fresh Air/Recirculate Switch

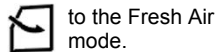

3.) Turn ON the Fan Control Dial

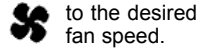

4.) Turn the Air Flow Control Dial

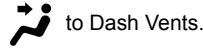

5.) Adjust the Temperature Control Dial counterclockwise until the air temperature feels comfortable.

## To Heat

1.) Turn ON the Fan Control Dial

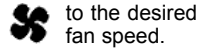

2.) Turn the Air Flow Control Dial



3.) Adjust the Temperature Control Dial clockwise until the air temperature feels comfortable.

## To Dehumidify

1.) Push the Fresh Air/Recirculate Switch

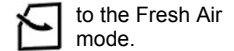

2.) Turn ON the Air Conditioning Switch.



3.) Turn ON the Fan Control Dial

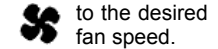

4.) Adjust the Temperature Control Dial until the air temperature feels comfortable.

The air conditioner removes moisture from the air while the heater heats the air.

# HEATING AND AIR CONDITIONING

---

3



## CAUTION

During extreme cold weather, do not blow hot defroster air onto cold windshields. This could crack the glass. Turn the Air Flow Control Dial to Defrost and adjust the fan speed accordingly while the engine warms. If the engine is already warm, move the Temperature Control Dial to cool, then gradually increase the temperature when you see that the windshield is starting to warm up. Failure to comply may result in equipment damage.

Fresh air and air conditioning are automatically turned ON.

3.) Adjust the Temperature Control Dial clockwise to full heat.

### To Defog and Defrost the Windshield

1.) Turn the Fan Control Dial



clockwise to the highest fan speed.

2.) Turn the Air Flow Control Dial



to Defrost Vents.

# AUDIBLE ALERTS

## Introduction

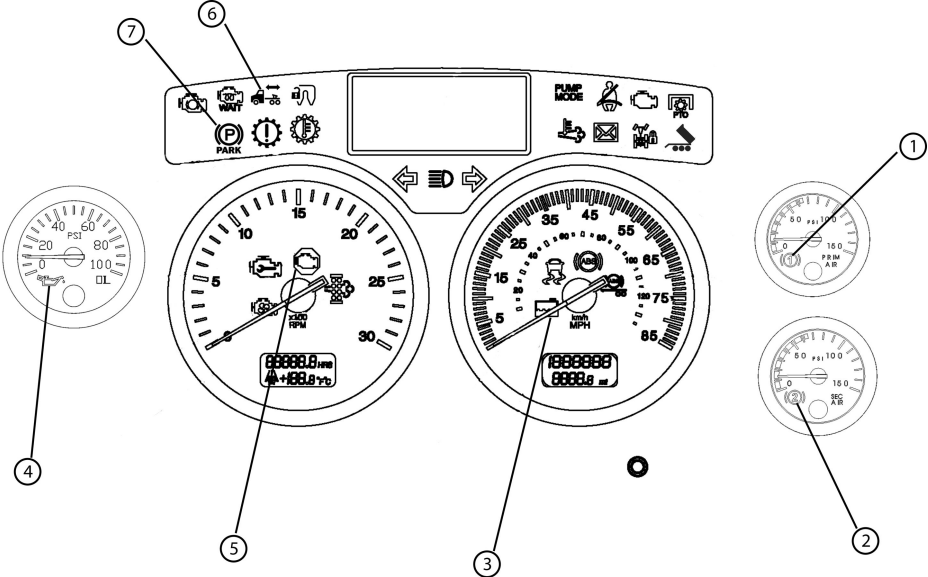

## AUDIBLE ALERTS

---

3

Your vehicle's dash and instrumentation uses various methods to indicate to you the status of various systems, or that one or more of your vehicles systems may be malfunctioning. The method to communicate or alert you of a particular condition is by:

- Audible alarm tone
- Audible warning tone
- Indicator light(s)

In some cases, you may have both an alarm or warning tone accompanied by an indicator light(s).









### WARNING!

Do not ignore any type of tone or lights. These signals tell you that something is malfunctioning on your vehicle and provide you an indication of what system is affected. It could be a failure of an important system, such as the brakes, which could lead to an accident and may result in personal injury, death, equipment or property damage.

Please remember that each Kenworth is custom made. Your instrument panel may not look exactly like the one in the illustration.

**Table 1 Audible Alerts**

Symbol Name	Symbol	Color	Standard	Option	Page
1. Brakes, Air Pressure in Primary Air System is Low		Red	•		on page 3-21
2. Brakes, Air Pressure in Secondary Air System is Low		Red	•		on page 3-21
3. Engine, Low Coolant Level		Yellow	•		on page 3-22
4. Engine, Oil Pressure		Yellow	•		on page 3-22
5. Engine, Stop Engine		Red	•		on page 3-40
6. Fifth Wheel Slide		Red	•		on page 3-22
7. Park Brake		Red	•		on page 3-43

## AUDIBLE ALERTS

---

The standard instrument cluster generates three distinct audible tones or sounds.

A. Alarm tone

B. Warning tone

C. Turn signal/hazard sound

D. Alert screens Multi-Function Display

The alert screens, tones and sound are described below.

### A. Alarm Tone

- Series of clear bell tones, repeated at a rate of **100** tones per minute.
- Indicates that something is seriously wrong with the vehicle that should be considered an emergency.



#### WARNING!

Do not ignore an alarm tone. You should visually determine what system is affected by glancing at your gauges and indicator lights, then begin to slow your vehicle down to a stop as safely as possible. Turn off your ignition and take appropriate action. The vehicle must be serviced and the problem corrected before driving the vehicle again. Failure to obey an Alarm tone may result in personal injury, death, equipment or property damage.

The Alarm tone is activated under the following conditions.

### Stop Engine Alarm



This alarm sound is active when the Stop Engine light is active (turned on by the engine). Examples of the conditions that would cause the alarm to sound are low oil pressure or high engine coolant temperature. Follow the procedure in the Emergency Section of this manual on page 2-3.



## Primary or Secondary Low Air Warning Alarm



Primary



Secondary

This alarm tone is active when either the Primary or Secondary Low Air Warning lamp is active and the engine RPM is above 300. This occurs when the primary or secondary air pressure drops below 65 psi (448 kPa), and stays active until it increases above 66.5 psi (458 kPa). The tone is only active when the engine is running (RPM above 300).

## Engine Oil Pressure Alarm



This alarm sound is active when the Engine Oil Pressure light is active (turned on by the engine).

## Park Brake Alarm



With the park brake not set and the door open, the Alarm tone is activated for approximately 4.5 minutes and park brake warning light will blink.

## B. Warning Tone

- Series of clear bell tones, similar to the Alarm tone, repeated at a rate of **60** tones per minute.
- Sounds when a problem exists, but the vehicle can still be safely driven. Service the vehicle to correct the problem but the situation should not be considered an emergency.

 CAUTION
<p>If a warning tone sounds, determine the system affected by glancing at your indicator lights. The warning tone indicates a problem exists, but the vehicle can still be safely driven. Service the vehicle at your earliest convenience to correct the problem, but the situation should not be considered an emergency.</p>

The Warning tone is activated under the following conditions.

## AUDIBLE ALERTS

---

**During the Instrumentation Power On Self Test (POST)** - Two bell tones sound when the ignition is turned on.

All gauges, indicators and warning lights will turn on for a power-on self test. Additionally, all indicator and warning lights will turn on together, then off together. Several different audible warnings will also be activated twice without break.

### Fifth Wheel Slide Warning



Light is active (turned on by the optional switch on the dash).

### Low Coolant Level Warning



Light is active (turned on by the engine), and engine is running (RPM above 300).

### C. Turn Signal/Hazard Sound

- Generates a tic-toc sound, similar to a sound and function of a mechanical flasher.
- Sounds anytime the turn signal or hazard switch is turned On.

i	NOTE
	<p>If the vehicle turn signals and turn signal indicators in the dash gauge cluster ever begin flashing at an accelerated rate (115 cycles per minute) when the turn signal lever is in the OFF (center) position, or when a Right/Left turn has been selected, the problem may be related to a failed turn signal switch or turn signal module. In either case, the problem is not a failed bulb. Contact your nearest authorized Kenworth Dealer to have the problem corrected as soon as possible.</p>

# INDICATORS

## INDICATORS

### Introduction

3

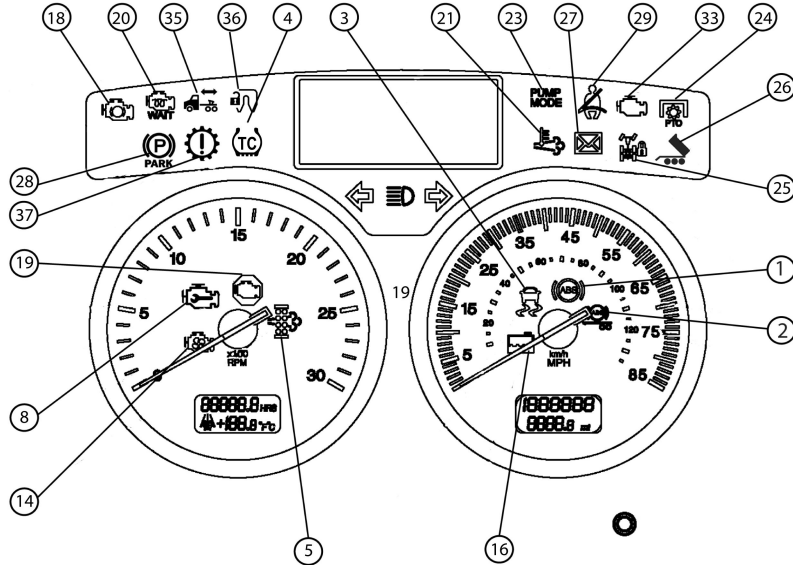

Numbered items in illustration are standard or common indicators.

Your vehicle's dash and instrumentation uses various methods to indicate to you the status of various systems, or that one or more of your vehicles systems may be malfunctioning. The method to communicate or alert you of a particular condition is by:

- Audible alarm tone
- Audible warning tone
- Indicator light(s)







In some cases, you may have both an alarm or warning tone accompanied by an indicator light(s).







	<b>WARNING!</b>
<p>Do not ignore any type of tone or lights. These signals tell you that something is malfunctioning on your vehicle and provide you an indication of what system is affected. It could be a failure of an important system, such as the brakes, which could lead to an accident and may result in personal injury, death, equipment or property damage.</p>	

Please remember that each Kenworth is custom made. Your instrument panel may not look exactly like the one in the illustration.







# INDICATORS

**Table 2 Indicators**







Symbol Name	Symbol	Color	Standard	Option	Page
1. Anti-Lock Brake System (ABS)		Yellow	•		on page 3-32
2. Anti-Lock Brake System (ABS), Trailer		Yellow	•		on page 3-32
3. Axle, Stability Control		Yellow	•		on page 3-34
4. Axle, Traction Control		Yellow	•		on page 3-34
5. Diesel Particulate Filter (DPF)		Yellow	•		on page 3-35
6. Dump Truck, Body Up		Red		•	on page 3-35

Symbol Name	Symbol	Color	Standard	Option	Page
7. Engine BrakeSaver or Transmission Retarder		Yellow		•	on page 3-36
8. Engine, Check Engine		Yellow	•		on page 3-36
9. Engine, Ether Start		Green		•	on page 3-36
10. Hill Hold		Yellow		•	on page 3-37
11. Lane Departure Warning (LDW)		Yellow		•	on page 3-37
12. Service Transmission		Yellow		•	on page 3-37
13. Worn brake		Red		•	on page 3-38







## INDICATORS



Symbol Name	Symbol	Color	Standard	Option	Page
14. Engine, Fan		Green	•		on page 3-38
15. Engine, Heater		Yellow		•	on page 3-38
16. Engine, Low Coolant Level		Yellow	•		on page 3-39
17. Engine, Overspeed		Red		•	on page 3-39
18. Engine, Retarder (Brake)		Green		•	on page 3-39
19. Engine, Stop Engine		Red	•		on page 3-40
20. Engine, Wait To Start		Yellow		•	on page 3-40



Symbol Name	Symbol	Color	Standard	Option	Page
21. High Exhaust System Temperature		Yellow	•		on page 3-40
22. Lights, High Beam		Blue	•		on page 3-41
23. Pump Mode	<b>PUMP MODE</b>	Green		•	on page 3-41
24. Power Take-Off (PTO)		Yellow		•	on page 3-41
25. Inter Axle Lock		Green		•	on page 3-42
26. Trailer Body Up		Red		•	on page 3-42
27. Message Waiting		Green		•	on page 3-42

## INDICATORS

Symbol Name	Symbol	Color	Standard	Option	Page
28. Park Brake		Red	•		on page 3-43
29. Seat Belt, Fasten		Red	•		on page 3-43
30. Transmission, Oil Temperature High		Yellow		•	on page 3-43
31. Turn Signal, Left		Green	•		on page 3-44
32. Turn Signal, Right		Green	•		on page 3-44
33. Malfunction Indicator Lamp (MIL)		Yellow		•	on page 3-44
34. Water In Fuel (WIF)		Yellow		•	on page 3-45

Symbol Name	Symbol	Color	Standard	Option	Page
35. Fifth Wheel Slide Unlocked		Red		<ul style="list-style-type: none"><li>•</li></ul>	on page 3-45
36. Fifth Wheel King Pin Lock		Red		<ul style="list-style-type: none"><li>•</li></ul>	on page 3-45
37. Check Transmission		Red		<ul style="list-style-type: none"><li>•</li></ul>	on page 3-46

# INDICATORS

## 1. Anti-Lock Brake System (ABS)



Illuminates during the Instrumentation System Self Test. Have the ABS checked by an authorized dealer if the ABS Warning Lamp stays on for more than 3 seconds.

- Illuminates during normal operating conditions to indicate a problem with the ABS.
- Illuminates when a problem exists with Automatic Traction Control (ATC).

See also Automatic Traction Control on page 4-33.

i	NOTE
After servicing the ABS, the lamp stays on after the power-on self test. This indicates that the ABS wheel sensors have not been checked by the ABS. As soon as the vehicle is driven at speeds above 4 mph (6 km/h) the lamp turns off, indicating that the wheel sensors have been checked by the ABS.	

## 2. Anti-Lock Brake System (ABS), Trailer



**A.** It illuminates during the power-on self test when the ignition is turned ON. It turns off after a few seconds if no system problems are detected. The bulb self-test is performed whenever the ignition is turned ON, regardless of whether you have Trailer ABS. If a Trailer ABS system is detected, the lamp will turn off after a few seconds if no system problems are detected.

	<b>CAUTION</b>
<p>If the Trailer ABS Warning Lamp does not turn on during the power-on self test, there may be a problem with the light or wiring. You should have this checked as soon as possible.</p>	

**B.** If it turns on at any other time, it is indicating that a problem exists with the Power Line Communication (PLC) trailer ABS. This should be checked by a Kenworth dealer as soon as possible. (Refer to "Trailer ABS" in the *Operator's Manual* for more information.)

**C.** If your tractor and trailer have the "Special Trailer ABS (Without PLC) Option", (Refer to "Special Trailer ABS (Without PLC) Option" in the *Operator's Manual* for more information.) this lamp will turn on when the trailer ABS has a system problem. This should be checked by a

Kenworth dealer as soon as possible. Power on self test for trailer ABS is controlled by the cluster and occurs under all conditions.

	<b>CAUTION</b>
<p>If the Trailer ABS Warning Lamp does not turn on during the power-on self test there may be a problem with the light or wiring. You should have this checked as soon as possible.</p>	

	<b>NOTE</b>
<p>Tractors/Trucks and trailers built after 3/1/01 must be able to turn on an In-Cab Trailer ABS Warning Lamp (per U.S. FMVSS121). The industry chose PLC as the standard method to turn it on. (Refer to "Trailer ABS" in the <i>Operator's Manual</i> for more information.)</p>	

	<b>NOTE</b>
<p>The Trailer ABS Warning Lamp will not turn on when connected to trailers with ABS (but without PLC) powered through the primary 7-way trailer light line. Use the lamp on the driver's side of the trailer to identify trailer ABS problems.</p>	

	<b>NOTE</b>
<p>For doubles or triples, the lamp does not distinguish between trailers. An ABS problem in any of the trailers will activate the Trailer ABS Warning Lamp.</p>	

## INDICATORS

---

### 3. Axle, Stability Control (ESC or Electronic Stability Control)



3

Calculates the driver's intended path of travel from wheel speed and steering angle sensors, then compares calculations to the actual direction of travel. The system uses individual wheel brakes to re-adjust the path of the vehicle.

- Illuminates during the power-on self-test when the ignition is turned ON. It turns off after a few seconds if no system problems are detected. If an ESC problem is detected, the ESC warning lamp will turn on and stay on.
- Illuminates when the ESC system is regulating individual wheel

brakes to correct the vehicle's direction of travel.

### 4. Axle, Traction Control (ATC or Automatic Traction Control)



Watches vehicle's wheel speeds to detect slippage and may reduce engine power, or apply vehicle brakes, to help increase traction.

- Illuminates during the power-on self-test when the ignition is turned ON. It turns off after a few seconds if no system problems are detected. If an ATC problem is detected, the ATC warning lamp will turn on and stay on.
- Illuminates when the ATC is regulating wheel spin and turns off after the traction control event has ended.

- Flashes continuously when the ATC/ Deep Snow & Mud switch is turned on, indicating that this feature is active.

5. Diesel Particulate Filter (DPF)



Illuminates when diesel particulate filter needs regeneration (controlled by Engine Control Module (ECM)). This warning lamp will illuminate even if the regeneration operation is disabled. (Refer to the *Engine Manufacturer's Operator Manual* and the *PACCAR Engine After-treatment Control Operator Manual* for additional information.)

	NOTE
<b>Only for engines equipped with emissions aftertreatment.</b>	

6. Dump Truck, Body Up



Illuminates when Truck Dump Body is up.

## INDICATORS

---

### 7. Engine BrakeSaver or Transmission Retarder



3 Illuminates when BrakeSaver (export only) or Transmission Retarder is active.

### 8. Engine, Check Engine



Illuminates when a problem exists, but the vehicle can still be safely driven. Vehicle should be serviced to correct the problem, but the situation should not be considered an emergency.

The Check Engine lamp will activate for several reasons. These include but are not limited to Water in Fuel, No-Idle Shutdown alert screens, High Exhaust Temperature, Diesel Particulate Filter (DPF) and Diesel Exhaust Fluid (DEF) warning lights. You may need to refer to your Engine Operator's Manual for additional information.



#### NOTE

**Only for engines equipped with emissions aftertreatment.**

### 9. Engine, Ether Start



Illuminates when ether start switch is on.



**10. Hill Hold  
(Eaton Ultrashift Plus)**



Blinks when disabled by switch (once per second), or continuous with fault.

The hill stop aid prevents unwanted vehicle movement on steep grades when transitioning from the brake to throttle pedal.

**11. Lane Departure Warning (LDW)**



Illuminates when optional LDW system is not able to track the vehicle's position within the lane.

i	NOTE
For vehicles equipped with Lane Departure Warning, please refer to Lane Departure Warning Driver's Guide for additional information.	

**12. Service Transmission**



Illuminates when Allison 1000/2000 transmission requires service.

## INDICATORS

---

### 13. Worn Brake



Illuminates when brake pads on optional Brake Warning System require replacement.

### 14. Engine, Fan



Illuminates when fan is active.

### 15. Engine, Heater



Illuminates when Engine Heater switch is on.

16. Engine, Low Coolant Level



Illuminates and an audible warning tone will sound when coolant level in the radiator is critically low.

	<b>CAUTION</b>
The vehicle must be serviced to correct the problem, but the situation should not be considered an emergency.	

17. Engine, Overspeed



Illuminates when engine RPM is exceeded (Allison Transmissions).

18. Engine, Retarder (Brake)



Illuminates when the engine retarder (compression brake) or exhaust brake switch is on (Smartwheel only).

## INDICATORS

---

### 19. Engine, Stop Engine

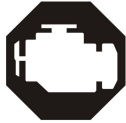

### 20. Engine, Wait To Start



### 21. High Exhaust System Temperature



3

Illuminates and an audible alarm tone will sound when a major engine system problem exists.



#### **WARNING!**

This should be considered an emergency. You should stop the vehicle as safely as possible and turn OFF the ignition. The vehicle must be serviced and the problem corrected before driving again. Failure to do so may cause severe engine damage or cause an accident which may result in personal injury or death.

Illuminates when engine grid heater is on. (PACCAR PX-6, PX-8, and Cummins ISL engines)

Illuminates when exhaust temperature is high (controlled by Engine Control Module (ECM)). (Refer to the *Engine Manufacturer's Operator Manual* and the *PACCAR Engine After-treatment Control Operator Manual* for additional information.)

**22. Lights, High Beam**



Illuminates when the high beams are on.

The high beam indicator will flash and a tone will sound to indicate that the head lamps are left on when: the head lamp switch is ON, the driver's door is open, AND the key switch is OFF.

**23. Pump Mode**



Illuminates when optional pump switch is activated.

**24. Power Take Off (PTO)**



Illuminates when optional PTO is active.

## INDICATORS

---

### 25. Inter Axle Lock



3

It illuminates when the inter-axle differential switch is ON thus locking the inter-axle differential. This powers the forward rear and the rear rear differentials equally. When the switch is turned off (inter-axle unlocked) the engine power is allowed to flow to any of the 4 drive tires based on the differential effect (mostly to the forward rear differential). (This feature is standard on all tandem axles).

### 26. Trailer Body Up



Illuminates when optional trailer body up switch is activated.

### 27. Message Waiting



Illuminates with telematic equipped messaging.

28. Park Brake



Illuminates when parking brakes are applied.

The Park Brake lamp will flash and the warning tone will sound anytime the Park Brake is not set and the driver's door is open.

Audio alarm will sound if the park brake is set and speed is greater than 5 miles per hour.

29. Seat Belt, Fasten



Illuminates for 5 seconds whenever the ignition key is turned on, then it turns off. The warning lamp may also come on if the driver's seat belt is not fastened (if the vehicle was ordered with a seat belt warning light option).

30. Transmission, Oil Temperature High



Illuminates when transmission lubricant temperature is too high.

	CAUTION
<p>This should be considered an emergency. You should stop the vehicle as safely as possible and turn OFF the ignition. The vehicle must be serviced and the problem corrected before driving again. Failure to do so may cause severe transmission damage.</p>	

## INDICATORS

---

### 31. Turn Signal, Left



Blinks when the left turn signal is operating.

### 32. Turn Signal, Right



Blinks when the right turn signal is operating.

### 33. Malfunction Indicator Lamp (MIL)



Illuminates when an engine emissions failure has occurred. The vehicle can be safely driven but should be serviced to correct the problem. The situation should not be considered an emergency. In some cases, the Malfunction Indicator Lamp will activate in conjunction with the High Exhaust Temperature, Diesel Particulate Filter (DPF) and Diesel Exhaust Fluid (DEF) Warning Lights.



#### NOTE

**Only for engines equipped with emissions aftertreatment.**



34. Water In Fuel (WIF)



Illuminates when water has been detected in the fuel.

35. Fifth Wheel Slide



Illuminates when fifth wheel slide switch is activated. Indicates fifth wheel can move.

36. King Pin Lock



Illuminates when king pin lock switch is activated. Indicates the king pin is disengaged.

## INDICATORS

---

### 37. Check Transmission



A fault with transmission.

3

(Refer to transmission manual)

# GAUGES AND DISPLAYS

## Introduction

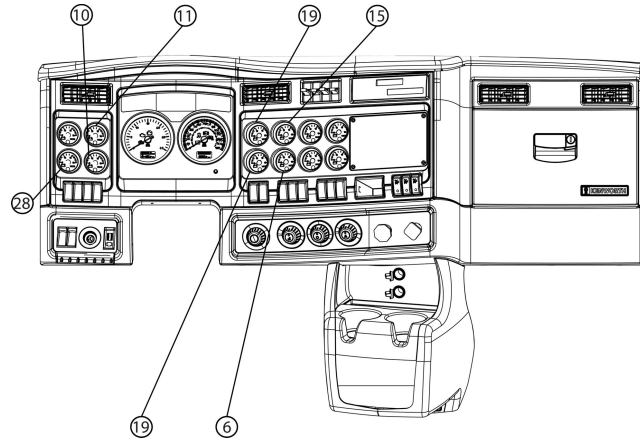











Numbered items in illustration are standard or common gauges.

Your vehicle includes both standard and optional gauges in the instrument cluster display. Some optional warning light indicators will be inoperable unless that option was specified with the vehicle. (See Warning Light/Indicator Symbols on page 3-26, for a complete list of standard and optional gauges and warning light indicators.)











# GAUGES AND DISPLAYS

## Gauges

Table 3 Gauge Symbols









Symbol Name	Symbol	Std	Opt	Page
1. Air Filter Restriction Pressure			•	on page 3-54
2. Ammeter			•	on page 3-54
3. Axle, Drive Oil Temperature	<p>Front</p>  <p>Rear</p>  <p>Center (Tridem)</p> 		•	on page 3-55
4. Axle, Pusher Air Pressure, #1, #2, #3	  		•	on page 3-55
5. Axle, Tag Air Pressure			•	on page 3-56
6. Brake, Application Air Pressure			•	on page 3-56



## GAUGES AND DISPLAYS

Symbol Name	Symbol	Std	Opt	Page
7. Diesel Exhaust Fluid (DEF)		•		on page 3-56
8. Engine, Coolant Temperature		•		on page 3-57
9. Engine, Oil Pressure		•		on page 3-59
10. Engine, Oil Temperature			•	on page 3-60
11. Fuel Filter Restriction Pressure			•	on page 3-60
12. Fuel Level, Primary and Secondary (if equipped)	<p><b>Primary</b></p>  <p><b>Secondary</b></p> 	•	•	on page 3-61
13. General Air Pressure #1, #2	<p>#1</p>  <p>#2</p> 		•	on page 3-62
14. General Oil Temperature			•	on page 3-62
15. Manifold Pressure (Turbo Boost)			•	on page 3-62

# GAUGES AND DISPLAYS

3

Symbol Name	Symbol	Std	Opt	Page
16. Primary and Secondary Air Pressure	Primary (1) Secondary (2)	•		on page 3-63
17. Suspension Load Air Pressure, #1, #2	#1  #2 		•	on page 3-64
18. Tractor Brake Application Air Pressure			•	on page 3-65
19. Trailer Brake Application Air Pressure			•	on page 3-65
20. Trailer Air Tank Air Pressure			•	on page 3-66
21. Transfer Case Oil Temperature			•	on page 3-66
22. Transmission Oil Temperature, Main			•	on page 3-66
23. Transmission Oil Temperature, Auxiliary			•	on page 3-67

Symbol Name	Symbol	Std	Opt	Page
24. Transmission Retarder Oil Temperature			•	on page 3-67
25. Voltmeter			•	on page 3-67

## Speedometer

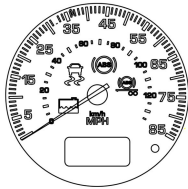

The Speedometer indicates the vehicle speed in miles per hour (mph) and in kilometers per hour (km/h). The Speedometer cluster also includes several warning and indicator lamps (see Audible Alerts on page 3-17) and an Odometer/Trip Meter.

## Odometer/Trip Meter

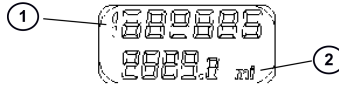

- 1 Odometer
- 2 Trip Meter

The LCD display in the lower part of the speedometer contains the Odometer and the Current Trip Meter.

The odometer displays the distance your vehicle has traveled. It will display in miles on an English cluster or in kilometers on a metric cluster. The maximum distance that can be shown on the odometer is 999,999 before it rolls over to zero.

The current trip odometer displays how far the vehicle has gone on a particular trip. The trip odometer will display in miles on an English cluster or in kilometers on a metric cluster, in one tenth divisions. The maximum distance that can be shown on the trip odometer is 9999.9 before it rolls over to zero.

	NOTE
	Pressing the trip odometer reset button 4 times in less than 4 seconds will change the odometer units.

To reset the trip odometer, press and hold the button on the cluster. The numbers will reset to 0 and begin to count new miles/km traveled.

## GAUGES AND DISPLAYS

To select a different trip, refer to Kenworth Multi-Function Display Operator Manual.

	<b>NOTE</b>
<p>The Odometer/Trip Meter comes on when the door is opened and when the ignition key is in the ACC or ON position. The Odometer/Trip Meter will remain on for 3 seconds after the door is closed or the ignition switch is turned off. This allows driver and service personnel to read the odometer without ignition switch being turned on.</p>	

### Tachometer

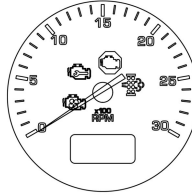

The Tachometer measures the engine speed in revolutions per minute (RPM). The Tachometer cluster also includes several warning and indicator lamps (see Audible Alerts on page 3-17) and an Engine Hour Meter and Outside Temperature Display.

Watching the tachometer is important to driving efficiently. It will let you match driving speed and gear selection to the operating range of your engine. If the engine speed gets too high, you can select a higher gear to lower the RPM's. If the engine speed drops too low, you can select a lower gear to raise the RPM's. (Refer to Driving Tips

and Techniques on page 4-5 for further instructions on driving techniques and using the tachometer.) To avoid engine damage, do not let the pointer exceed maximum governed speed. (See your *Engine Operation and Maintenance Manual* for RPM recommendations.)



## Engine Hours/Outside Air Temperature

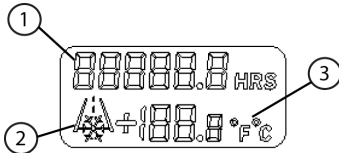

- 1 Hour Meter
- 2 Outside Air Temperature
- 3 Snowflake Symbol

The LCD display in the lower part of the tachometer contains the Engine Hour Meter and the Outside Air Temperature display.

The engine hour meter will display the total number of hours the engine has been running. The maximum hours that can be shown are 99999.9 before the meter rolls over to zero.

The Outside Air Temperature (OAT) will display the temperature outside the vehicle. The temperature can be

displayed from  $-40^{\circ}$  to  $158^{\circ}$  F or  $-40^{\circ}$  to  $70^{\circ}$  C.

The display will also alert the driver when the outside temperature approaches freezing ( $32^{\circ}$  F or  $0^{\circ}$  C) by displaying a snowflake symbol. The symbol will turn on when the temperature drops below  $34^{\circ}$  F or  $11^{\circ}$  C and flash for the first 3 seconds, then stay on until the temperature goes above  $37^{\circ}$  F or  $28^{\circ}$  C.

The OATs units (Fahrenheit or Celsius) can be changed by pressing the reset button on the cluster 4 times in less than 4 seconds.

	<b>CAUTION</b>
Modifying the sensor or its location can impact vehicle performance, emissions, and/or reliability.	

	<b>NOTE</b>
The OAT will come on when the door is open and when the ignition key is in the ACC or ON position. The OAT display will turn off when the ignition switch is turned off.	

	<b>NOTE</b>
The OAT uses a sensor (located at the bottom of the driver's side mirror assembly) to measure outside air temperature only. It is not capable of displaying the temperature of the road surface on either the temperature display or the snowflake icon. Additionally, the OAT reading may be affected by exposure to direct sunlight.	

# GAUGES AND DISPLAYS

## 1. Air Filter Restriction Pressure



3

The Air Filter Restriction Pressure gauge indicates the condition of the engine air cleaner and is measured by inches of water (H<sub>2</sub>O). A clean filter should register 7 in. H<sub>2</sub>O (may vary with system design) and a filter whose life is over will register approximately 20 in. H<sub>2</sub>O. The red light will come on when it has reached a critical level. This critical level is determined by engine and air filter selections.

CAUTION	
Continued operation with the Air Filter Restriction Gauge reading 20 in. H <sub>2</sub> O may cause damage to the engine. Inspect the filter and replace if necessary. Holes in the paper element render an air cleaner useless and may cause the Air Filter Restriction Gauge to give a false reading, whether the element is clogged or not. Replace the element if it is damaged. Failure to comply may result in equipment damage.	

## 2. Ammeter

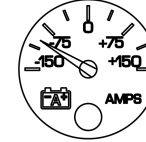

The ammeter tells you whether the vehicle batteries are being charged by the alternator or discharging. Positive reading indicates the batteries are charging, negative reading indicates the batteries are discharging.

Under normal conditions the ammeter will read nearly "zero". If it begins to read noticeably above or below the "zero" balance, have the system checked out immediately. If you do not, you could have a roadside breakdown.

## 3. Axle, Drive Oil Temperature

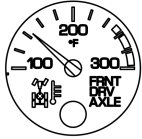

Front Drive Axle

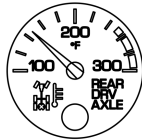

Rear Drive Axle

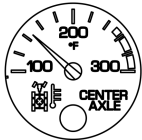

Center Drive Axle (for Tridem Axle configuration)

The Drive Axle Oil Temperature gauges (front, rear, and center) indicate the temperature of the lubricant in your vehicle's axles. These temperatures will vary with the kind of load you are carrying and the driving conditions you encounter. The red light will come on when the temperature has reached a critical level.

	<b>NOTE</b>
Very high temperatures signal a need to have the axle(s) lubrication checked.	

## 4. Axle, Pusher Air Pressure

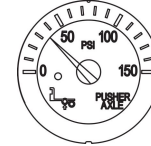

Pusher Axle #1

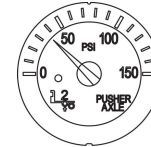

Pusher Axle #2

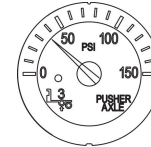

Pusher Axle #3

The Pusher Axle Air Pressure gauge(s) indicate the air pressure in the pusher axle(s) suspension air bags.

# GAUGES AND DISPLAYS

## 5. Axle, Tag Air Pressure



## 6. Brake, Application Air Pressure

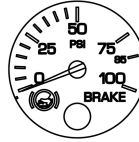

## 7. Diesel Exhaust Fluid (DEF)

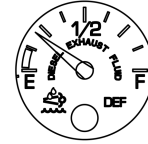

3

The Tag Axle Air Pressure gauge indicates the amount of air pressure in the tag axle suspension air bags.

The Brake Application air gauge indicates how much air pressure is being applied from the foot brake valve or trailer brake hand valve to the air brakes.

The Diesel Exhaust Fluid gauge indicates the total (approximate) amount of DEF in the tank. In addition to indicating empty and full, the gauge also indicates the DEF level in graduated increments. When the DEF level in the tank reaches 10% full, a red warning light in the gauge illuminates, when the DEF level in the tank reaches 5%, the red light flashes. Refer to your PACCAR Engine After-Treatment Control Operator's Manual for more information.

## 8. Engine, Coolant Temperature



The Engine Coolant (water) Temperature gauge indicates the temperature of the engine coolant.

If the coolant temperature exceeds the maximum limits, a red warning lamp in the gauge will turn on and an audible warning will sound. If the coolant temperature continues to rise, the Check Engine and/or Stop Engine lights will also come on.

	<b>CAUTION</b>
<p>This should be considered an emergency. You should stop the vehicle as safely as possible and turn OFF the ignition. The vehicle must be serviced and the problem corrected before driving again. Failure to do so may cause severe engine damage.</p>	

Under normal operating conditions, the water temperature gauge should register between 165° and 205° F (74° and 90° C). Under certain conditions, somewhat higher temperatures may be acceptable. The maximum allowable temperature is 220° F (104° C) with the cooling system pressurized, except for certain engines. Check the engine manual to be sure.

## Overheating Engine

The cooling system may overheat if the coolant level is below normal or if there is sudden loss of coolant, such as a split hose. The system may also temporarily overheat during severe operating conditions such as:

- Climbing a long hill on a hot day
- Stopping after high-speed driving

	<b>NOTE</b>
<p>If one of the prior conditions occur, <b>DO NOT TURN OFF THE ENGINE</b> unless: <b>a)</b> the Low Water warning device indicates a loss of coolant, <b>b)</b> the Red Warning lamp (on the gauge) and Check Engine lamp comes ON, <b>c)</b> the Audible Warning or Audible Alarm sounds showing an overheat condition, or <b>d)</b> you have any other reason to suspect the engine may be overheating, follow these steps.</p>	

## GAUGES AND DISPLAYS

---

3

1. Reduce engine speed or stop. When stopped, place the transmission in Neutral and set the parking brake. (Refer to Using the Parking Brake on page 4-20 and Putting the Vehicle in Motion on page 4-71.)
2. Check to ensure the Oil Pressure Gauge reads normal. (See the Engine Oil Pressure in Gauges and Displays on page 3-47, for further information.)
3. Make sure the engine fan is turned on by switching the Engine Fan Switch from AUTO to MAN (Manual).
4. Increase the engine speed to about one-half of full operating speed, or 1,100 to 1,200 rpm, maximum.
5. Return the engine speed to normal idle after 2 or 3 minutes.
6. Monitor the engine temperature. After the temperature returns to normal, allow the engine to idle 3 to 5 minutes before shutting it off. This allows the engine to cool gradually and uniformly.
7. If overheating came from severe operating conditions, the temperature should have cooled by this time. If it has not, stop the engine and let it cool before checking to see if the coolant is low.
  - Wait until the coolant temperature is below 122° F (50° C).
  - Protect face, hands, and arms by covering the cap with a large, thick rag to protect against escaping fluid and steam.
  - Carefully and slowly turn the cap one-quarter of a turn or until it reaches the first stop.
  - Allow excess pressure to escape, then push down and turn for final removal.

For further information on engine temperature and operating engines properly, see the *Engine Operation and Maintenance Manual*. Check the coolant level after each trip when the engine has cooled. The coolant level should be visible within the sight gauge (glass level indicator) on the surge tank; add coolant if necessary. (Refer to Topping Up on page 5-65, for instructions on checking and filling the coolant expansion tank.)



## WARNING!

Do not remove the radiator fill cap while the engine is hot. Scalding steam and fluid under pressure may escape. You could be badly burned. Failure to comply may result in personal injury or death.



## WARNING!

To reduce the chance of death, personal injury, fire and/or vehicle damage from overheated engines, never leave the engine idling without an alert driver present. If the engine should overheat, as indicated by the engine coolant temperature light, immediate action is required to correct the condition. Continued unattended operation of the engine, even for a short time, may result in serious engine damage or a fire. Failure to comply may result in personal injury, death, equipment or property damage.

## 9. Engine, Oil Pressure

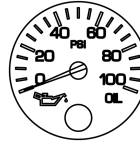

It is important to maintain oil pressure within acceptable limits. If oil pressure drops below the minimum psi a red warning light in the gauge will turn on, the Stop Engine light will come on and an audible alarm tone will sound.



## CAUTION

Continuing to operate your vehicle with insufficient oil pressure will cause serious engine damage.

- If the oil pressure fails to rise within 10 seconds after the engine starts, stop the engine and determine the cause.

- Check the engine manufacturer's manual for the correct oil pressure ranges for your vehicle's engine.
- If the oil pressure suddenly drops, or the audible alarm and engine oil pressure warning light come on while driving, do the following:
  1. Slow down carefully.
  2. Move a safe distance off the road and stop.
  3. Place the transmission in park and set the parking brake. (Refer to *Operator's Manual* for "Parking Brake Valve" and "Operating the Transmission" for transmission shifting and parking brake information.)
  4. Turn OFF the engine.
  5. Turn ON the emergency flasher and use other warning devices to alert other motorists.

## GAUGES AND DISPLAYS

3

- Wait a few minutes to allow oil to drain into the engine oil pan, and then check the oil level. (Refer to *Operator's Manual* for "Oil Level Check" for details on checking oil level.)
- Add oil if necessary. If the problem persists, contact an authorized Kenworth Dealer.

For further information on engine oil and normal operating pressures, see the *Engine Operation and Maintenance Manual*.

For further information on engine gauges and operating your engine properly, refer to *Operator's Manual* for "Engine Maintenance".

### 10. Engine, Oil Temperature

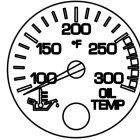

The Engine Oil Temperature gauge indicates the engine oil temperature. If the oil temperature exceeds the maximum limits, a red warning light in the gauge will turn on. Do not exceed maximum engine oil temperature recommended by the engine manufacturer. (See the *Engine Operation and Maintenance Manual* for details.)

### 11. Fuel Filter Restriction Pressure

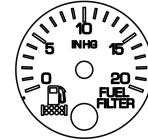

This gauge tells you the condition of the fuel filter by indicating the restriction from the fuel filter to the fuel pump. The restriction is measured by inches of mercury (Hg). Check the engine manual for proper restriction. Replace the filter with an approved filter only. Do not substitute the wrong micron element.

i	NOTE
	The maximum allowable restriction could vary according to the type or make of engine. Consult the engine manufacturers manual or engine dealer for fuel restriction specifications.



## 12. Fuel Level, Primary Secondary (if equipped)

The Primary Fuel gauge and Secondary Fuel gauge (if equipped) indicate the total (approximate) amount of fuel in each fuel tank. In addition to indicating empty and full, the gauge(s) also indicate the fuel level in graduated increments. When the fuel level for each tank is below 1/4 full, a red warning light in the gauge will come on.



Primary



Secondary

i	<b>NOTE</b>
For Export vehicles, the fuel gauges will not state: ULTRA LOW SULFUR DIESEL FUEL ONLY.	

i	<b>NOTE</b>
Kenworth manufactures vehicles that are built with different fuel systems and draw tube locations. Because of this and the amount of road crown, it is recommended that you do not operate your vehicle with less than one-quarter of your truck's fuel capacity. Allowing the fuel level to go below one-quarter of capacity could result in the lack of fuel to keep the engine running. In addition, you will want to keep the fuel tanks at least half-full to reduce condensation of moisture in the tanks. This moisture can damage the engine.	

⚠	<b>WARNING!</b>
Do not carry fuel containers or any container used to store combustible liquids. Failure to comply may result in personal injury, death, equipment or property damage.	

⚠	<b>WARNING!</b>
Do not remove a fuel tank cap near an open flame. Fuel vapors may be hot and combustible and can cause an explosion or fire. Failure to comply may result in personal injury, death, equipment or property damage.	

Refer to Refueling on page 4-80 for more information.

# GAUGES AND DISPLAYS

## 13. General Air Pressure #1, #2

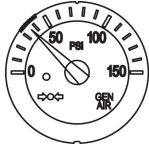

General Air Pressure #1

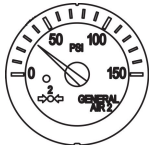

General Air Pressure #2

The General Air Pressure gauge(s) are used for customer installed component applications.

## 14. General Oil Temperature

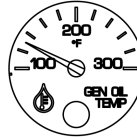

The General Oil Temperature gauge(s) are used for customer installed component applications.

## 15. Manifold Pressure (Turbo Boost)



If the pressure indicated by the manifold pressure gauge goes down, there may be something wrong with the engine. Have it checked by a qualified service person.

## 16. Primary and Secondary Air Pressure

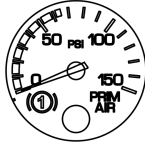

Primary Air Pressure

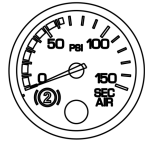



Secondary Air Pressure

The Primary Air Pressure gauge indicates pressure in the rear braking system. The Secondary gauge indicates pressure in the front braking system. Each gauge indicates the amount of air pressure in each system in pounds per square inch (psi).

On vehicles equipped with metric air pressure gauges, the gauge face plate includes a kPa (major) scale and psi (minor) scale.

	<b>NOTE</b>
Be sure the air pressure registers more than 100 psi (689 kPa) in both service systems before you move the vehicle.	

	<b>NOTE</b>
If the pressure in either or both circuits falls below 65 psi (448 kPa), a red warning light in the gauge will turn on and an audible alarm tone will sound when the engine is running.	

	<b>WARNING!</b>
If the air pressure falls below 60 psi (414 kPa), the spring brakes may stop the vehicle abruptly which could cause an accident resulting in personal injury or death. Observe the red warning lamps on the gauges. If one comes on, do not continue to drive the vehicle until it has been properly repaired or serviced.	

**⚠ WARNING!**

The air pressure warning light and the audible alarm tone indicate a dangerous situation: there is not enough air pressure in the air tanks for repeated braking and the brake system has failed. Without the use of your service brakes your spring brakes could suddenly apply causing a wheel lock-up, loss of control, or over-take by following vehicles. This may cause an accident resulting in personal injury or death. Bring the vehicle to a safe stop right away, while you still have control of the vehicle. Refer to the following procedure:

### Air Loss Emergency Procedure

1. Slow down carefully.
2. Move a safe distance off the road and stop.
3. Place the transmission in neutral (park with automatic transmissions, if equipped) and set the parking brake. (Refer to Parking Brake Valve on page 3-94 and Operating the Transmission on page 4-70 for transmission shifting and parking brake information.)
4. Turn OFF the engine.
5. Turn ON the emergency flasher and use other warning devices to alert other motorists.

If the light and alarm do not turn off at startup, do not try to drive the vehicle until the problem is found and fixed. (Refer to Using the Brake System on page 4-17 for more brake information.)

### 17. Suspension Load Air Pressure, #1, #2

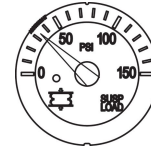

Suspension Load Air Pressure #1

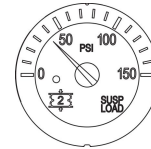

Suspension Load Air Pressure #2

The Suspension Load Air Pressure gauge indicates the amount of air pressure in the air suspension air bags.

When the vehicle is equipped with dual leveling valves, the #1 gauge indicates the air pressure in the driver's side air bags. The #2 gauge indicates the air pressure in the passenger's side air bags.

### 18. Tractor Brake Application Air Pressure

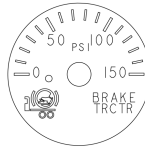

The Tractor Brake Application Air Pressure gauge indicates the amount of air pressure applied to the tractor brakes.

i	NOTE
This gauge will be included when the Trailer Brake Application Air Pressure gauge is ordered.	

### 19. Trailer Brake Application Air Pressure

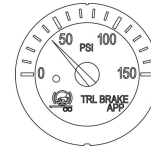

The Trailer Brake Application Air Pressure gauge indicates the amount of air pressure applied to the trailer brakes during brake foot valve and/or hand brake control valve applications.

# GAUGES AND DISPLAYS

## 20. Trailer Air Tank Air Pressure

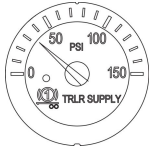

## 21. Transfer Case Oil Temperature

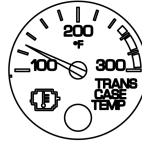

## 22. Transmission Oil Temperature, Main

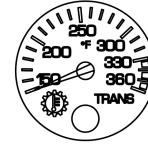

3

The Trailer Air Tank Air Pressure gauge indicates the amount of air pressure in the trailer brake air tank.

The Transfer Case Oil Temperature gauge indicates the temperature of the oil in the transfer case. If the oil temperature exceeds maximum limits, a red warning light in the gauge will turn on. Do not exceed maximum oil temperature recommended by the manufacturer. (See the *Transfer Case Operation and Maintenance Manual* for details.)

The Main Transmission Oil Temperature Gauge indicates the temperature of the oil in the transmission.

	NOTE
Watch this gauge to know when the transmission is overheating.	

Do not exceed maximum oil temperature recommended by the manufacturer. (See the *Transmission Operation and Maintenance Manual* for details.)

## 23. Transmission Oil Temperature, Auxiliary

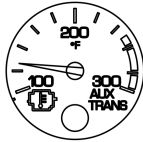

The Auxiliary Transmission Oil Temperature gauge indicates the temperature of the oil in the auxiliary transmission.

i	NOTE
Watch this gauge to know when the transmission is overheating.	

Do not exceed maximum oil temperature recommended by the manufacturer. (See the *Transmission Operation and Maintenance Manual* for details.)

## 24. Transmission Retarder Oil Temperature

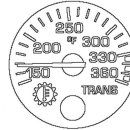

The Transmission Retarder Oil Temperature gauge indicates the temperature of the oil in the transmission retarder.

i	NOTE
Watch this gauge to know when the transmission is overheating.	

Do not exceed maximum oil temperature recommended by the manufacturer. (See the *Transmission Operation and Maintenance Manual* for details.)

## 25. Voltmeter

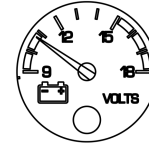

The Voltmeter displays the battery voltage. Normally, it should show 12 to 14V (volts). A red warning light in the gauge turns on when an out of range condition exists.

i	NOTE
Even with a healthy charge/start system, the voltmeter may fall below 12V during engine cranking. If voltage drops below 12V and stays there, have the electrical system checked.	

# MULTI-FUNCTION DISPLAY

## Introduction

This section explains the location and function of the various instruments and controls on your vehicle.

3

Please remember that each Kenworth is custom made. Your instrument panel may not look exactly like the one in the illustration below. Described below are the most common instruments and controls available.

## Alarms, Warning Tones and Visual Indicator Lights

### Introduction

Your vehicle's dash and instrumentation uses various methods to indicate to you the status of various systems, or that one or more of your vehicle's systems may be malfunctioning. The method to communicate or alert you of a particular condition is by:

- Audible alarm tone
- Audible warning tone
- Indicator light(s)

In some cases, you may have both an alarm or warning tone accompanied by an indicator light(s).



### WARNING!

Do not ignore any type of tone or lights. These signals tell you that something is malfunctioning on your vehicle and provide you an indication of what system is affected. It could be a failure of an important system, such as the brakes, which could lead to an accident and may result in personal injury, death, equipment or property damage.



## Warning and Information Alert Screens

The Multi-Function display has various alert screens that are either warnings, or informational.



No Idle Shutdown

The No-Idle Shutdown screen is activated upon engine shutdown due to extended idle time while not moving.



Cruise Control Rationality (Brake/Clutch)

The Cruise Control Rationality screen is displayed when attempting to activate the cruise control prior to depressing both the service brake pedal and the clutch pedal. For vehicles with automated transmissions and no clutch pedal, only the service brake pedal needs to be depressed.



Park Brake On While Moving

The Park Brake On While Moving warning screen is displayed when the Park Brake is on and the vehicle speed is greater than zero and/or the accelerator pedal position is greater than 10%.

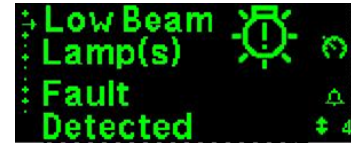

Lamp Faults - Low/High Beam

The Lamp Faults screen is displayed when an error is detected in the headlamp circuits.



Regen Inhibited

The Regen Inhibited due to Switch screen is displayed when a regeneration is required and the DPF switch is in the inhibit position.

## MULTI-FUNCTION DISPLAY



DEF (Low Diesel Exhaust Fluid)

3

The DEF Warning screen is displayed when the DEF Fluid level has reached a critically low level. It may be suppressed by pushing enter on the MCS (Menu Control Switch). See Menu Control Switch on page 3-77. This warning may be accompanied by the DEF Level in the low range, DEF Lamp on solid or flashing, the Check Engine lamp, the Stop Engine lamp, the MIL lamp, and/or engine de-rate.

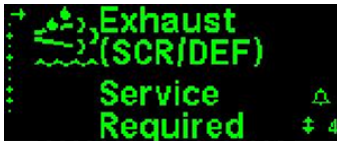

SCR/DEF

The Exhaust (SCR/DEF) Service Required screen is displayed when either the SCR system has been tampered with or the DEF quality is below standards. It may be suppressed by pushing enter on the MCS (Menu Control Switch). See Menu Control Switch on page 3-77. This warning may be accompanied by the DEF Lamp flashing, the Check Engine lamp, the Stop Engine lamp, the MIL lamp, and/or engine de-rate.



Trailer Fault

The Trailer Fault screen is displayed when an error is detected in the trailer circuits.



Low Voltage Disconnect

The Low Voltage Disconnect (LVD) screen is displayed when the system voltage falls to 12.1 volts.



Over-Crank Protection

Over-Crank Protection screen is displayed when the starter motor is being protected from over heat or from being engaged while the engine is running.

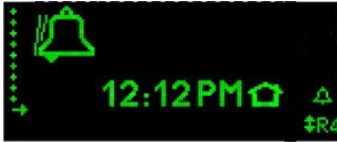

Alarm Clock Active

The Alarm Clock Active screen is displayed when the Alarm is on and the Alarm time equals clock/local time. The Alarm Clock Active screen will be displayed for approximately 10 minutes and may be suppressed by pressing MCS (Menu Control Switch) enter, which turns off the alarm. See Menu Control Switch on page 3-77.



Cruise Control Screen

The Cruise Control Set screen is displayed when the Cruise Control is active and the Set/Resume switch is used. The current cruise control speed will be displayed.

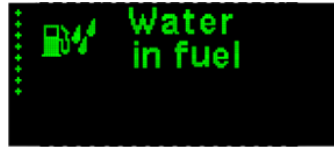

Water In Fuel

The Water In Fuel (WIF) screen is displayed when the WIF sensor detects water in the fuel.



Circuit Failure

The Circuit Failure screen is displayed when a circuit fault is detected. This screen is accompanied with the hazard indicators and low beam headlamps.



Hydrocarbon Burn

The "Do Not Drive 10 Minute Parked Regen Required" is displayed when unburned hydrocarbons or water vapor are trapped in the Diesel Particular Filter (DPF). These need to be burned off before the vehicle is driven. This warning may be accompanied by the DPF lamp on or flashing, the Check Engine Lamp, the Stop Engine Lamp and/or engine derate. An audible alarm will engage when the vehicle starts moving while this warning is active.

## MULTI-FUNCTION DISPLAY



Engine Protection Shutdown Timer



Front Drive Axle Speed Warning

3

The "Shutdown" is displayed when the engine has derated and the situation requires the engine to turn off. The time to shutdown is displayed. This warning may be accompanied by the Check Engine Lamp, the Stop Engine Lamp and/or engine derate. A restart of the engine is possible with minimal function to ensure safe operation. It may be suppressed by pushing on the MCS (Menu Control Switch). See Menu Control Switch on page 3-77.

The "Attention Front Axle Is Engaged" is displayed when the front drive axle is engaged and the vehicle has exceeded a pre-determined speed. An audible alert will sound when the warning is displayed.



Engine Over-Speed Shutdown Low Air Warning

The "Overspeed Shutdown May not work due to low-air" is displayed when the system air pressure is to low to

guarantee that the Air Inlet Valve will shut for overspeed conditions. It may be suppressed by pushing on the MCS (Menu Control Switch). See Menu Control Switch on page 3-77. There is an accompanying audio alarm, which will continue to sound as long as the conditions are true even if the pop-up has been suppressed.

### What You Should Do

If an alert screen comes on while driving, do the following:

1. Slow down carefully.
2. Move a safe distance off the road and stop.
3. Set the parking brake. (Refer to Operator's Manual for "Operating the Transmission" and "Operating the Brake System".)
4. If the engine is overheating do not turn it off (see "Overheating Engine" in the Operator's Manual); otherwise, for other conditions turn the engine OFF.
5. Turn on the emergency flasher and use other warning devices to alert other motorists.

### Wingman® ACB Warning Tone / Alert Screens

- Series of high pitched rings that repeat at different rates. See the following warning descriptions and corresponding number of tones per minute.
- Indicates one of the following scenarios; your vehicle is too close to the vehicle ahead, a stationary object has been detected, or there is an active fault in the Wingman® ACB system.



Level 3 Following Distance Alert

This Wingman® ACB warning tone is active when the following distance is less than what is set in the Wingman®

ACB system. This is the least severe of all the ACB warning tones. The high pitched ring will have a single beep repeating at a rate of 42 tones per minute.



Level 2 Following Distance Alert

This Wingman® ACB warning tone is active when the following distance is less than what is set in the Wingman® ACB system. This ACB warning tone is more severe than the Level 3 Following Distance Alert. The high pitched ring will have a double beep repeating at a rate of 80 tones per minute (40 double beeps per minute).

## MULTI-FUNCTION DISPLAY



Level 1 Following Distance Alert

3

This Wingman® ACB warning tone is active when the following distance is less than what is set in the Wingman® ACB system. This ACB warning tone is the most severe following distance alert. The high pitched ring will have a continuous beep repeating at a rate of 188 tones per minute.



Impact Alert

This is the most severe warning issued by Wingman® ACB. The warning tone

is active when the driver must take immediate evasive action by applying more braking power and/or steering clear of the vehicle ahead to avoid a potential collision. The high pitched ring will have a solid tone for a 3 second duration.



Fault Alert

This Wingman® ACB warning tone is active when there is a fault in the Wingman® ACB system. The high pitched ring will have a single beep that is not repeating.



Stationary Object Alert

This Wingman® ACB warning tone is active when the system detects a sizable stationary object with reflective surfaces in your lane of travel. The high pitched ring will have a continuous beep repeating at a rate of 188 tones per minute.



### WARNING!

The Wingman® ACB sensor may not be able to detect vehicles and objects with limited metal surfaces (such as recreational vehicles, horse-drawn buggies, motorcycles, logging trailers, etc.). Failure to understand the system limitation may result in death, serious injury, and/or property damage.



Disabled Alert

This Wingman® ACB is able to use the vehicle's foundation brakes as a last resort in attempt to keep the set following distance. This alert screen is active once the system stops applying the foundation brakes because cruise control is disabled.



Not Available Alert

This Wingman® ACB alert screen is active after a cruise set/resume switch activation with a fault in the ACB system. It is also used as the

brake overuse alert when the system is intervening and using the foundation brakes excessively.

## Multi-Function Display

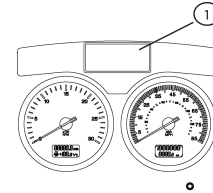

1 Multi-Function Display

	<b>WARNING!</b>
<p>Do not look at the Multi-Function Display for prolonged periods while the vehicle is moving. Only glance at the monitor briefly while driving. Failure to do so can result in the driver not being attentive to the vehicle's road position, which could lead to an accident involving personal injury, death or vehicle damage.</p>	

The Multi-Function Display integrates the following list of functions (menu items) into one display.

# MULTI-FUNCTION DISPLAY

3

- Blank Screen (for night driving)
- Engine RPM Display
- Fuel Economy Display
- Ignition Timer
- Trip Information Display
- Truck Information Display
- On-Board Diagnostic Display
- Transmission Gear Display (automated transmissions only)
- Clock Display
- Collision Avoidance
- Settings Screen

The Multi-Function Display, located above the primary instrument cluster will display important vehicle information through a constant monitor of systems. The display will turn on

whenever one of the following are activated:

- Ignition key is in ON or ACC positions
- Ignition timer is ON (active)
- MCS button is pushed (independent of ignition key switch position)
- Clock alarm sounds
- Driver or passenger door is opened
- Hazard warning lamp switch is ON
- Head lamp switch is ON
- Dome lamp switch is ON
- Service Brake switch is ON

## Menu Navigation & Definitions

Table 4 Menu Item Accessibility

Menu Items	Accessi-ble while Driving	Accessi-ble while Parked
Blank Screen	Yes	Yes
Fuel Economy	Yes	No
RPM Detail	Yes	Yes
Ignition Timer	No	Yes
Trip Information	Yes	Yes
Truck Information	No	Yes
Diagnostic Display	No	Yes
Transmission Gear Display	Yes	Yes
Clock Display	Yes	Yes
Collision Avoidance	Yes	Yes
Settings Screen	No	Yes



## Right Hand Status Bar and Definitions



Right Hand Status Bar





**Cruise Control Active** - Icon will indicate when cruise control is active or the cruise set speed will be displayed (optional). Icon looks like a clock dial face.



**Alarm On Indicator** - The right hand status bar is equipped with a clock warning bell. If the alarm has been set, the bell will be displayed with no animation. When the alarm is active, the bell shows animation.

-  **Gear Display (for automatic transmissions only)** - Displays present gear.

	<b>NOTE</b>
<p>This gear display will only be displayed in the right-hand status bar if the operator has not selected the Transmission Display. If the Transmission Display is selected, a larger gear icon and the current gear number will be displayed while driving. (See Transmission Display on page 3-81 for additional information.)</p>	

-  **Shift Indicator (option)** - Prompts the driver when to shift up on manual transmissions for fuel economy.

## Left Hand Menu Bar

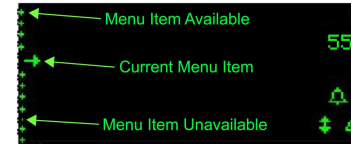

The left hand menu bar (menu bullets) gives the status of the current menu item. Scroll through the menu items by rotating the Menu Control Switch (MCS) clockwise (down the menu) or counterclockwise (up the menu). Select a menu item by pressing the MCS. Some menu items require the MCS to be pressed to access Submenu information.

# MULTI-FUNCTION DISPLAY

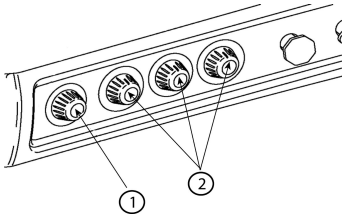

3

- 1 Menu Control Switch (MCS)
- 2 Heater and Air Conditioning Controls

## Menu Items

**A. Blank Screen** - No information or graphics displayed.

## B. Fuel Economy



Fuel Economy

- 1. **Bar graph** - Indicates instantaneous fuel economy.
- 2. **Trip Econ.** - Indicates trip fuel economy.

## C. RPM Detail



RPM

RPM reading of actual engine RPM. Engine RPM within the bar graph chevrons (in range zone) indicates the engine is operating in the most efficient RPM range.

## D. Ignition Timer



Ignition Timer

Ignition timer is set from this menu. To set the timer, push the MCS on the ignition timer menu (bullet). Then rotate the MCS to the desired time (0 to 30 minutes). After the time expires, the vehicles ignition (switched) power will be shut off (if the ignition key is in the OFF position).

## E. Trip Information

<b>i</b>	<b>NOTE</b>
<p>When accessing the trip information menu, push the MCS on this menu (bullet). To exit, push the MCS again. To reset the trip values, press the Trip Odometer Reset Button on the main gauge instrument cluster.</p>	



Trip Information

### Trip Info (submenu):

#### Instant Info

1. Trip Economy (Accessible when driving) - Indicates trip fuel economy.

2. Average Speed (Accessible when driving) - Indicates trip average speed (not including idling).

#### Trip Result

1. Trip Distance - Indicates total trip distance.
2. Trip Engine Hours - Indicates total trip engine hours.

#### Idle Info

1. Trip Engine Hours - Indicates total trip engine hours.
2. Trip Idle Percentage (%) - Indicates total trip idle percentage.

#### PTO Info (Optional)

1. PTO Hours - Indicates total vehicle PTO operation hours.
2. PTO Trip Hours - Indicates total trip PTO operation hours. To reset the Trip Values, press the Trip

Odometer Reset Button on the main gauge instrument cluster.

3. PTO Trip (%) (Accessible when parked) - Indicates total trip PTO percentage.
4. PTO Trip Fuel - Indicates total trip PTO fuel.
5. PTO Trip Economy - Indicates total trip PTO economy.

<b>i</b>	<b>NOTE</b>
<p>Display functions for PTO hours, PTO Trip Hours and PTO Trip Percentage will only be available if supported by the engine installed. If the truck has a factory-installed PTO, these fields will appear in the Trip Information screen. If the engine does not support the data, dashes will be shown.</p>	

# MULTI-FUNCTION DISPLAY

3

## F. Truck Information

	<b>NOTE</b>
Only available truck information will be shown (i.e., manual transmissions do not have a software version).	

	<b>NOTE</b>
When accessing the truck information menu, push the MCS on this menu (bullet). To exit, push the MCS again.	



Truck Information

Truck Info (submenu):

Chassis Info

1. Chassis Number
2. Fleet ID Number (Optional)
3. Cab Electronic Control Unit (CECU) Software Version

Engine Info

1. Engine Make
2. Engine Model
3. Engine Software Version
4. Governed Speed Limit (Optional)

Transmission Info (Automated Transmissions only)

1. Transmission Make
2. Transmission Model
3. Transmission Software Version

ABS Info

1. ABS (Anti-Lock Braking System) Make

2. ABS Model
3. ABS Software Version

## G. Diagnostic Display

	<b>NOTE</b>
"Faults Found" will only be active if a red or yellow warning lamp is illuminated and additional information is available.	



Diagnostic Display

The diagnostic display menu (bullet) will indicate a fault that is present. While on this menu item the display will either indicate "No Faults Found" or "Faults Found". If "Faults Found" is active, pushing the MCS on this

menu item will show "Exit", "Engine", "Transmission", "ABS", "Truck", and/or "Soot Filter". Exit will take you back to the diagnostic menu bullet and clicking on any of the other items will display an active vehicle diagnostic message.

## H. Transmission Display (Automated Transmissions only)

i	NOTE
Refer to the Automated Transmission Operator's Manual for complete description of arrow symbols.	

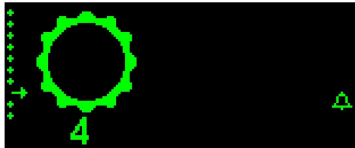

Transmission Display

Shows gear number that coincides with the current transmission gear

selected. Can also indicate to driver to shift up or down.

## I. Speed Control Management Display (Automated Transmissions only)



Upshift Indicator while on Transmission Gear Screen with Autoshift or Ultrashift Transmissions

The "Shift for fuel econ." is displayed when the current screen is Transmission Display And the engine requests an upshift for better fuel economy.

## J. Clock Display



Clock Display

Shows Local or Home time as selected by the driver. The time can also be set to show 12 hour time (AM/PM) or 24 hour time (military). Refer to the "Settings Menu" section for additional information covering clock/alarm and formatting options.

# MULTI-FUNCTION DISPLAY

## K. Settings Menu

The Settings menu screen allows the driver to view and/or change the following menu items:

- Clock Display Format 12 Hour (AM/PM) or 24 Hour (military)
- Clock Home/Local Time
- Clock Alarm ON/OFF
- Clock Local Time (Set)
- Clock Alarm Time (Set)
- Trailer Detect
- Headlamps With Wipers
- Units Standard or Metric
- Language English, Spanish or French
- Pre-Trip Lamp Test
- Exit



Settings Menu

### To Set Clock Display Format:

1. When in the settings menu, scroll through the list of menu items to "Format".
2. Press the MCS to display either 12 hour (AM/PM) or 24 hour (military time).



Clock Display Format

### To Set Clock Home/Local Time:

1. Scroll through the list of menu items to Time: Home or Local. Press the MCS to toggle between Home or Local time.

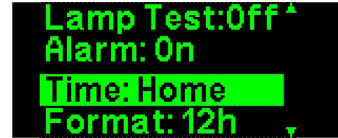

Clock Home/Local Time

2. To change the selected time (Home or Local), rotate the MCS to the Settings screen. Press the MCS to select it.
3. When in the menu settings, scroll through the list of menu items to Set Clock Time (for home time) or Set Local Time. Press the MCS to select it.



Set Clock Time

4. Rotate the MCS to change the hour. Press the MCS. Rotate the MCS again to change the minutes. Press the MCS to set the new time.



Set Hour/Minutes

5. To exit the screen, rotate the MCS to Exit, then press the MCS.



Exit

### To Set Alarm Time:

1. Rotate the MCS to the "Settings" menu. Press the MCS.
2. When in the Settings menu, scroll through the list of menu items to "Set Alarm Time". Press the MCS to select it.



Set Alarm Time

3. Rotate the MCS to change the hour. Press the MCS. Rotate the MCS again

to change the minutes. Press the MCS to set the new alarm time.

4. To exit the screen, rotate the MCS to Exit, then press the MCS.



Set Alarm Hour/Minutes

### To Turn Alarm ON/OFF:

1. Rotate the MCS to the "Settings" menu. Press the MCS.
2. When in the setting menu, scroll through the list of menu items to "Alarm".
3. Press the MCS to turn the alarm ON or OFF.

## MULTI-FUNCTION DISPLAY

3

	NOTE
Unless there is a loss of battery power, the display will always maintain the last screen from key off after the key is turned back to the on position and the POST cycle completes.	

4. To exit the screen, rotate the MCS to Exit, then press the MCS.

	NOTE
A bell icon appears in the clock display when the alarm has been set to ON.	

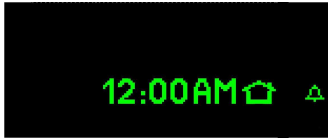

Alarm "On"

### To Activate Trailer Detect:

The trailer outputs on your vehicle may be able to detect whether or not a trailer is attached. Should a trailer connection be detected and later lost while driving the driver will be notified of the error. Errors will be presented to the driver as either intermittent or persistent depending on the duration of the error. All notifications may be suppressed by the driver.

1. Scroll to TRLR Detect and select by pressing the MCS.
2. Scroll to the desired ON/OFF setting.
3. When set to 'ON' Trailer Detect will be active when the ignition switch is in the 'ON' position.

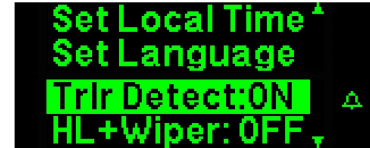

Trailer Detect

### To Activate Headlamps with Wipers:

1. Scroll to HL + Wiper and select by pressing the MCS.
2. Press MCS to toggle to the desired ON/OFF setting.
3. When set to 'ON' the Low Beam Lamps will be active when the ignition switch is in the 'ON' position and the Wiper Control Switch is 'ON'.



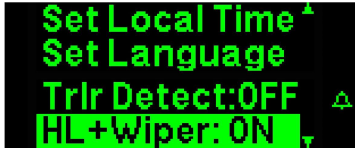

Headlamps with Wipers

### To Set Standard or Metric Units:

1. Rotate the MCS to the "Settings" menu. Press the MCS.
2. When in the Settings menu, scroll through the list of menu items to "Units". Press the MCS to display either Standard or Metric units.

### To Set Language:

1. Rotate the MCS knob to the "Settings" menu. Press the MCS.
2. When in the Settings menu, scroll through the list of menu items to "Language". Press the MCS to display either English, Spanish or French.

### L. Pre-trip Lamp Test

When activated with the MCS, 'Pre-trip Lamp Test Active' appears on the Multi-function display and will re-appear periodically while the test is active. The test will illuminate the following lamps:

Lamp	Sequence
Marker*	1, 2
Clearance*	1, 2
Headlamp low-beam	1
Headlamp high-beam	2
Auxiliary (fog or driving)	1, 2
Stop	2
Park*	1, 2
Hazard/Turn lamps	1

All lamps with sequence #1 will illuminate simultaneously for 10 seconds. All lamps with sequence #2 will illuminate simultaneously for 10 seconds immediately following

sequence #1. Each sequence will illuminate lamps for 10 seconds. With the default settings and without intervention the Pre-trip Lamp Test will deactivate after 10 minutes. Sequence time can vary from 10 seconds with a 10 minute duration up to 30 seconds and a 30 minute duration.

Asterisks (\*) indicate that dash switch must be ON for the Pre-trip Self Test to operate these lamps.



Pre-trip Lamp Test

# SWITCHES

# SWITCHES

## Introduction



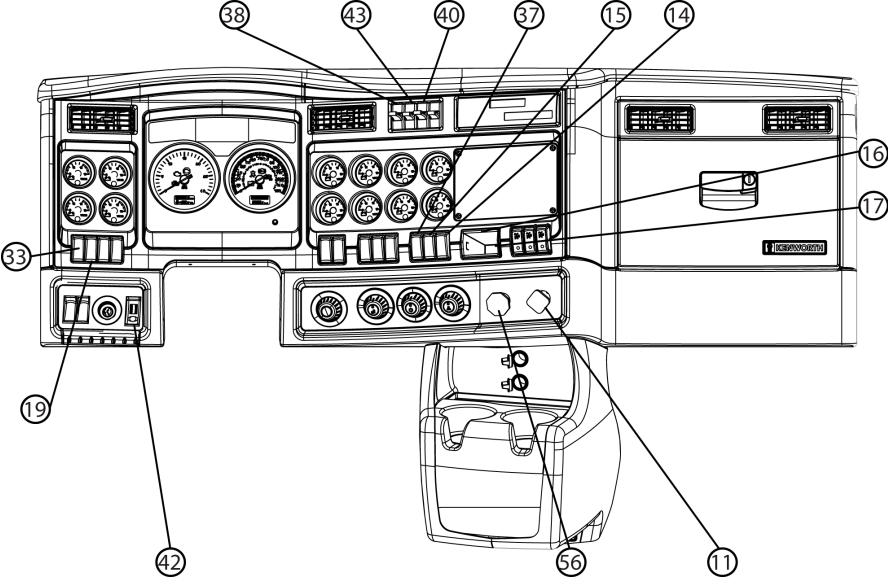





3















Numbered items in illustration are standard or common switches.













## Dash Switches

Table 5 Dash Switches













Symbol Name	Symbol	Color	Standard	Option	Page
1. Axle, Automatic Traction Control		None	•		See Axle, Automatic Traction Control on page 3-93.
2. Axle, Diff-Lock - Dual		Amber		•	See Axle, Diff-Lock - Dual on page 3-93.
3. Axle, Diff-Lock - Forward Rear		Amber		•	See Axle, Diff-Lock - Forward Rear on page 3-93.
4. Axle, Diff-Lock - Front		Amber		•	See Axle, Diff-Lock - Front on page 3-93.
5. Axle, Diff-Lock - Rear Rear		Amber		•	See Axle, Diff-Lock - Rear Rear on page 3-93.
6. Axle, Diff-Lock - Single Rear		Amber		•	See Axle, Diff-Lock - Single Rear on page 3-93.
7. Axle, Inter-Axle Differential Locked (Tandem)		Amber		•	See Axle, Inter-Axle Differential Locked (Tandem) on page 3-93.
8. Axle, Two Speed		Green		•	See Axle, Two Speed on page 3-93.
9. Back Up Alarm Mute		Amber		•	See Back Up Alarm Mute on page 3-93.
10. Batteries, Low Voltage Disconnect (LVD)		None	•		See Batteries, Low Voltage Disconnect (LVD) on page 3-93.











## SWITCHES

Symbol Name	Symbol	Color	Standard	Option	Page
11. Brakes, ABS Off-Road		Amber		•	See Brakes, ABS Off-Road on page 3-94.
12. Brakes, Parking Brake Valve		Red	•		See Brakes, Parking Brake Valve on page 3-94.
13. Dump Truck Gate		Red		•	See Dump Truck Gate on page 3-94.
14. Engine, Brake Level		None		•	See Engine, Brake Level on page 3-94.
15. Engine, Brake On/Off		Green		•	See Engine, Brake On/Off on page 3-94.
16. Engine, Cruise Control On/Off		Green	•		See Engine, Cruise Control On/Off on page 3-95.
17. Engine, Cruise Control Set/Resume	 SET RESUME	None	•		See Engine, Cruise Control Set/Resume on page 3-95.
18. Engine, Ether Start		None		•	See Engine, Ether Start on page 3-95.
19. Engine, Fan Override		Green		•	See Engine, Fan Override on page 3-95.
20. Engine, Heater		Green		•	See Engine, Heater on page 3-96.
21. Engine, Remote Throttle	 PUMP MODE	Amber		•	See Engine, Remote Throttle on page 3-96.
22. Engine, Shutdown		None		•	See Engine, Shutdown on page 3-96.









Symbol Name	Symbol	Color	Standard	Option	Page
23. Exhaust, Diesel Particulate Filter (DPF) Regeneration		None	•		See Exhaust, Diesel Particulate Filter (DPF) Regeneration on page 3-96.
24. Fifth Wheel Slide		Red		•	See Fifth Wheel Slide on page 3-96.
25. Fuel Heater		Amber		•	See Fuel Heater on page 3-97.
26. Generic Air, Accessory		Green		•	See Generic Air, Accessory on page 3-97.
27. Generic, Spare	<b>SPARE</b>	Green		•	See Generic, Spare on page 3-97.
28. Ignition Key Switch		None	•		See Ignition Key on page 3-97.
29. Lights, Auxiliary		Green		•	See Lights, Auxiliary on page 3-98.
30. Lights, Beacon		Green		•	See Lights, Beacon on page 3-98.
31. Lights, Daytime Running (Override)		Green		•	See Lights, Daytime Running on page 3-98.
32. Lights, Dome		None	•		See Lights, Dome on page 3-98.
33. Lights, Flood		Amber		•	See Lights, Flood on page 3-98.
34. Lights, Flood ISO 3732 Spare		Amber		•	See Lights, Flood ISO 3732 Spare on page 3-98.
35. Lights, Fog		Green		•	See Lights, Fog on page 3-98.

## SWITCHES

Symbol Name	Symbol	Color	Standard	Option	Page
36. Lights, Hazard		Red	•		See Lights, Hazard on page 3-99.
37. Lights, Headlight		None	•		See Lights, Headlight on page 3-99.
38. Lights, Marker/Clearance		None	•		See Lights, Marker/Clearance on page 3-99.
39. Lights, Marker/Clearance/Cab		None		•	See Lights, Marker/Clearance/Cab on page 3-100.
40. Lights, Marker/Clearance/Trailer		None		•	See Lights, Marker/Clearance/Trailer on page 3-100.
41. Lights, Panel Dimmer		None	•		See Lights, Panel Dimmer on page 3-100.
42. Lights, Park Light		None	•		See Lights, Park Light on page 3-100.
43. Lights, Spot		Green		•	See Lights, Spot on page 3-100.
44. Power Take-off (PTO)		Amber		•	See Power Take-off (PTO) on page 3-100.
45. Power Take-off (PTO), Forward		Amber		•	See Power Take-off (PTO), Forward on page 3-101.
46. Power Take-off (PTO), Rear		Amber		•	See Power Take-off (PTO), Rear on page 3-101.
47. Power Take-off (PTO), Brake/Clutch Kickout		Amber		•	See Power Take-off (PTO), Brake/Clutch Kickout on page 3-101.

Symbol Name	Symbol	Color	Standard	Option	Page
48. Roofdenser		Green		•	See Roofdenser on page 3-101.
49. Suspension, Air Retention		Amber		•	See Suspension, Air Retention on page 3-101.
50. Suspension, Axle, Pusher		Green		•	See Suspension, Axle, Pusher on page 3-101.
51. Suspension, Axle, Tag		Green		•	See Suspension, Axle, Tag on page 3-101.
52. Suspension, Dump		Amber		•	See Suspension, Dump on page 3-101.
53. Suspension, Lift		Amber		•	See Suspension, Lift on page 3-101.
54. Suspension, Third Axle Lift		Green		•	See Suspension, Third Axle Lift on page 3-101.
55. Tow Hook		Green		•	See Tow Hook on page 3-102.
56. Trailer Air Supply		Red	•		See Vehicle/Trailer Air Supply Valve on page 4-23.
57. Trailer, Axle (3rd Axle) Lift		Green		•	See Trailer, Axle (3rd Axle) Lift on page 3-102.
58. Trailer, Axle Lift Forward		Green		•	See Trailer, Axle Lift Forward on page 3-102.
59. Trailer, Axle Lift Rear		Green		•	See Trailer, Axle Lift Rear on page 3-102.

## SWITCHES

Symbol Name	Symbol	Color	Standard	Option	Page
60. Trailer, Belly Dump		Red		•	See Trailer, Belly Dump on page 3-102.
61. Trailer, Dump Gate		Red		•	See Trailer, Dump Gate on page 3-102.
62. Trailer, Dump Gate Center		Red		•	See Trailer, Dump Gate Center on page 3-102.
63. Trailer, Dump Gate Front		Red		•	See Trailer, Dump Gate Front on page 3-102.
64. Trailer, Dump Gate Rear		Red		•	See Trailer, Dump Gate Rear on page 3-102.
65. Trailer, Hotline		Green		•	See Trailer, Hotline on page 3-102.
66. Trailer, Suspension Air Dump		Amber		•	See Trailer, Suspension Air Dump on page 3-102.
67. Winch Clutch		Green		•	See Winch Clutch on page 3-102.
68. Trip Odometer Reset Button					Odometer/Trip Meter on page 3-51.



**1. Axle, Automatic Traction Control**

Momentarily push switch in to engage Deep Mud and Snow Traction Control. See Deep Snow and Mud Switch on page 4-34.

**2. Axle Diff-Lock - Dual**

Turn switch on to engage Front and Rear Axle Diff Lock.

**3. Axle Diff-Lock - Forward Rear**

Turn switch on to engage Forward Rear Axle Diff Lock.

**4. Axle Diff Lock - Front**

Turn switch on to engage Front Axle Diff Lock.

**5. Axle Diff-Lock Rear Rear**

Turn switch on to engage Rear Rear Axle Diff Lock.

**6. Axle Diff Lock - Single Rear**

Turn switch on to engage Single Rear Axle Diff Lock.

**7. Axle, Inter-Axle Differential Locked (Tandem)**

Turn switch on to engage Inter-Axle Differential Lock.

**8. Axle, Two Speed**

If equipped, the two speed axle switch allows you to select axle high and low ranges. The low range (Off) provides maximum torque for operating off-highway. The high range (On) is a faster ratio for highway speeds.

**9. Back Up Alarm Mute**

Turn switch on to mute Back Up Alarm.

**NOTE**

Kenworth discourages the use of the mute function. Only use mute when legally required.

**10. Batteries, Low Voltage Disconnect (LVD)**

If your vehicle is equipped with a Low Voltage Disconnect (LVD) feature, the LVD module is located inside the driver's side kick panel.

**Purpose**

The LVD may increase battery life and prevent unnecessary jump start conditions by ensuring that an unattended load does not deplete the battery charge to a level that will prevent you from starting your vehicle.

**Operation**

The LVD will disconnect non-vital battery loads when battery voltage drops below 12.3V for 3 minutes and the key switch is in the ACC or OFF position. During the last 2 minutes the LVD will emit a slow audible beep. 30 seconds before disconnecting loads the alarm will change to a fast beep. The battery voltage must come back

# SWITCHES

up above a certain voltage before the LVD will reset

See an authorized Kenworth Dealer if the LVD fails to reconnect loads during normal operation.

## Circuits Disconnected by LVD

- Cab Dome Lamps
- Cab Accessories
- Spare Battery A & B



### NOTE

All LVD circuits are color-coded blue on the central electrical panel cover label.



### WARNING!

Do not use the Spare Battery A & B circuits or other circuits that are controlled by the LVD to power electronic engine controls, ABS circuits, or safety/work-related lighting. Before adding any device to the vehicle's electrical system, consult your nearest authorized Kenworth Dealer or read the contents of TMC RP-136. Failure to do so may cause equipment damage or lead to personal injury.



### NOTE

The determination of what circuits/loads that were connected to the LVD was based upon the recommendation from Technology and Maintenance Council (TMC) of the American Trucking Association. To review the recommended practice, see TMC RP-136.



### 11. Brakes, ABS Off-Road

Turn switch on to engage ABS Off-Road mode. See Anti-Lock Braking System on page 3-32.



### 12. Brakes, Parking Brake Valve

Pull yellow knob to activate parking brakes. See Parking Brake Valve on page 3-94.



### 13. Dump Truck Gate

Turn switch on to open Dump Truck Gate.



### 14. Engine, Brake Level

In the up position there will be 100% engine retarding. In the middle position there will be 60% engine retarding. In the down position there will be 33% engine retarding.

For more information on when and how to use the engine brake in your vehicle, see the engine brake owner's manual for additional engine brake information.

**15. Engine, Brake On/Off**

Turn switch on to activate Engine Brake system.

For more information on when and how to use the engine brake in your vehicle, see the engine brake owner's manual for additional engine brake information.

**16. Engine, Cruise Control On/Off**

Turn switch on to activate Cruise Control System.

**17. Engine, Cruise Control Set/Resume**

The Cruise Control Set/Resume switch allows you to SET the desired speed or RESUME the desired speed after the cruise control function has been interrupted.

SET  
RES-  
UME

**WARNING!**

Do not operate the cruise control when operating on road surfaces with poor traction (wet, icy, or snow covered roads) or in heavy traffic. Accelerations caused by the normal operation of the cruise control could cause you to lose control of the vehicle resulting in an injury accident.

**18. Engine, Ether Start**

Momentarily push switch in to activate the Ether Start system.

**19. Engine Fan Override**

The engine fan switch allows you to control the engine fan manually or automatically. With the ignition key switch ON and the fan switch in the MANUAL position, the engine fan will be on regardless of engine temperature. With the engine fan switch in the AUTOMATIC position, the engine fan will automatically turn on when the engine coolant reaches a temperature of about 200°F (93°C) or when the air conditioning system has reached setpoint pressure. With an electronic engine, the fan may also be activated by air intake temperature, oil temperature and compression brake usage.

# SWITCHES

3

**⚠ WARNING!**

Do not work on or near the fan with the engine running. Anyone near the engine fan when it turns on could be seriously injured. If it is set at MANUAL, the fan will turn on any time the ignition key switch is turned to the ON position. In AUTO, it could engage suddenly without warning. Before turning on the ignition or switching from AUTO to MANUAL, be sure no workers are near the fan.

**⚠ CAUTION**

The fan or equipment near it could be damaged if the fan turns on suddenly when you do not expect it. Keep all tools and equipment away from the fan.

**⚠ CAUTION**

Do not operate the engine fan in the MANUAL position for extended periods of time. The fan hub was designed for intermittent operation. Sustained operation will shorten the fan hub's service life as well as reduce fuel economy.



**20. Engine Heater**

Turn switch on to activate the Engine Heater.



**PUMP MODE 21. Engine, Remote Throttle**

Turn switch on to activate Remote Throttle Control.



**22. Engine, Shutdown**

Momentarily push switch in to activate the shutdown system.



**23. Exhaust, Diesel Particulate Filter (DPF) Regeneration Switch**

Manually controls the diesel particulate filter regeneration process. Refer to Engine After-treatment Controls Operator's Manual for additional information.



**24. Fifth Wheel Slide**

Turn switch on to "Unlock" Fifth Wheel Slide mechanism.

**i NOTE**

Vehicles having an air slide fifth wheel have a fifth wheel slider lock controlled by a switch on the instrument panel. By placing the switch in the unlock position you can slide the fifth wheel to various positions to adjust weight distribution.

The switch is guarded to protect you from accidentally activating or releasing the lock.

**WARNING!**

Do not move the fifth wheel while the tractor-trailer is in motion. Your load could shift suddenly, causing you to lose control of the vehicle. Never operate the vehicle with the switch in the UNLOCK position. Always inspect the fifth wheel after you lock the switch to be sure the fifth wheel slide lock is engaged. Failure to comply may result in personal injury, death, equipment or property damage.

**25. Fuel Heater**

Turn switch on to activate Fuel Heater.

**26. Generic, Air, Accessory**

Provides accessory air to the end of frame connection when switch is turned on.

SP-  
ARE**27. Generic, Spare**

Turn switch on to power customer installed accessory.

**28. Ignition Key Switch**

The ignition key switch (located to the left of the steering column) has four positions: ACC (Accessories), OFF, ON, and START.

**OFF:** In this position all accessories are OFF (except those listed below) and you can remove the key.

- The following lights and accessories have power when the key is in the OFF position:
  - brake lights
  - emergency hazard flasher
  - dome and courtesy lamps (on doors)

- electric horn
- cigarette lighter
- tail lights
- marker lamps
- headlights
- radio station memory
- instrument lights
- auxiliary power
- multi-function display memory

**ACC (Accessory):** With the key in this position you can play the radio, defrost mirrors (if equipped with mirror heat) or use other accessories.

**ON:** In the ON position all circuits are energized. Panel warning lights will light and the buzzer will sound until (1) the engine is started, (2) normal oil operating pressure is reached, and (3)

# SWITCHES

air brake system pressure is above 64 psi (441 kPa). In this position, the ignition key cannot be removed.

**START:** Turn the key to this position to start your engine. Release the key after the engine has started. For complete engine starting procedures, see Operating the Engine on page 4-44.



### 29. Lights, Auxiliary

Turn switch on for Auxiliary Lights.



### 30. Lights, Beacon

Turn switch on for Beacon Light(s).



### 31. Lights, Daytime Running Lights (DRL) (with optional over-ride switch)

For T440s/T470s the front turn signals are used as DRLs at full intensity.

Three controls (or conditions) will affect whether the system is ON or OFF:

- headlight (master) switch
- engine cranking
- parking brake

If the headlight switch is turned OFF, the DRL system engages automatically after the engine starts and you release the parking brake. If the headlight switch is ON, the DRL system is overridden, and headlights operate normally. Also, during engine cranking the DRL is temporarily turned off.



## WARNING!

Do not use daytime running lights (DRL) during periods of darkness or reduced visibility. Do not use DRL as a substitute for headlights or other lights during operations that require lighting of your vehicle. Failure to comply may result in personal injury, death, equipment or property damage.



### 32. Lights, Dome

Turn switch on for Cab Dome Lights.



### 33. Lights, Flood

Turn switch on for cab mounted Flood Lights.



### 34. Lights, Flood ISO 3732 Spare

Turn switch on for trailer mounted Flood Lights.



### 35. Lights, Fog

Turn switch on for Fog Lights.

	<b>NOTE</b>
<p>Across the U.S.A. and Canada, State/Provincial requirements vary as to when high beams and fog lights can and cannot be used together. Some states allow only four lights to be used together, while some allow more. How your lights are arranged will affect whether you can operate headlights and fog lights concurrently—always comply with the state or provincial requirements where you are driving.</p>	



### 36. Lights, Hazard

The four-way Hazard Warning light switch is located directly above the Heater / A/C Control Panel. With the switch in the ON position, the emergency flasher makes all four turn signals (front and rear) flash simultaneously. The flasher works independently of the ignition switch. You should always use the flasher if the vehicle is disabled or parked under emergency conditions.

	<b>WARNING!</b>
<p>Use your Hazard Warning Light System any time you have to stop off the road or on the side of the road, day or night. A hard-to-see vehicle can result in an injury accident. Another vehicle could run into you if you do not set your flashers and follow the placement of emergency signals per FMCSR 392.22.</p>	



### 37. Lights, Headlight

Turn switch on for headlights. When the Headlights are ON, the dash lights, side, and tail lights are also on.

	<b>CAUTION</b>
<p>If you have confirmed there is a problem in the low beam wiring circuit, proceed with caution to the next available exit/turnoff and safely pull your vehicle completely off the road and call for assistance. Driving your vehicle with the headlamps on high beam (at reduced intensity) for a prolonged period could lead to an injury accident. Contact your nearest Kenworth dealer to have the problem corrected as soon as possible.</p>	



### 38. Lights, Marker/Clearance

Turn switch on to control Cab and Vehicle Marker/Clearance lights.

A separate switch next to the headlight switch turns on the marker lights for both the cab and trailer. These are the five amber lights on top of the cab, front trailer lights, and red rear truck/trailer lights.

# SWITCHES

3

	<b>NOTE</b>
An interrupt switch for the trailer marker lights is mounted on the end of the turn signal lever.	

 **39. Lights, Marker/Clearance/ Cab**

Turn switch on to control Cab Marker/Clearance lights separately from the trailer.

 **40. Lights, Marker/Clearance/ Trailer**

Turn switch on to control Trailer Marker/Clearance lights separately from the vehicle marker/clearance lights.



**41. Lights, Panel Dimmer**

Rotate thumb wheel up to brighten panel lights. Rotate thumb wheel down to dim panel lights.

	<b>NOTE</b>
The Headlamp Switch is an "ON" or "OFF" switch. The panel lights are on full intensity during the day & go to Dimmer mode when headlamps are on.	



**42. Lights, Park Light**

Turn switch on for Park Lights. When the Park Lights are on the dash lights, side and tail lights are also on.



**43. Lights, Spot**

Turn switch on for Spot Light.



**44. Power Take-off (PTO)**

Turn switch on to engage PTO.

Your Kenworth vehicle may be equipped with a dash mounted air switch that controls PTO engagement/disengagement.

When the operator activates the switch for the PTO, the status indicator lamp (located on the switch) will immediately illuminate even though PTO engagement may not have occurred.

If the PTO is engaged and the operator turns the switch OFF, the PTO status indicator lamp (located on the switch) will go out immediately even though PTO disengagement may not have occurred.

	<b>NOTE</b>
Actual PTO engagement/disengagement may be delayed momentarily since it is controlled by the air system and mechanical movement.	



 **CAUTION**

Increasing engine RPM before the PTO is actually engaged could prevent the PTO from engaging and/or cause PTO damage.

 **45. Power Take-off (PTO), Forward**  
Turn switch on to engage forward PTO.

 **46. Power Take-off (PTO), Rear**  
Turn switch on to engage Rear PTO.

IGNORE BRAKE/CLUTCH  
**47. Power Take-off (PTO), Brake/Clutch Kickout**  
Turn switch on to disable PTO when brake pedal or clutch pedal are depressed.

 **48. Roofdenser**  
Turn switch on for roof mounted condenser fan.

 **49. Suspension, Air Retention**  
The Air Retention Switch keeps the air suspension bags from losing air pressure when used with vehicle outriggers. Depress the Air Retention Switch prior to deploying the outriggers. While outriggers are deployed axle stability is maintained.

 **50. Suspension, Axle, Pusher**  
Turn switch on to lower Single or Forward Pusher Axle.

 **51. Suspension, Axle, Tag**  
Turn switch on to lower tag axle.

 **52. Suspension, Dump**  
Turn switch on to deflate suspension air bags. The switch is guarded to protect you from accidentally deflating the suspension.

 **WARNING!**

Do not operate the Air Suspension Deflate Switch (Dump Valve) while driving. Sudden deflation while your vehicle is moving can affect handling and control and could lead to an accident. Use this switch only when your vehicle is not moving. Failure to comply may result in personal injury, death, equipment or property damage.

 **CAUTION**

Operating a vehicle with air suspension bags either overinflated or underinflated may cause damage to driveline components. If a vehicle must be operated under such conditions, do not exceed 5 mph (8 km/h).

 **53. Suspension, Lift**  
Turn switch on to over-inflate suspension air bags. Turn switch off for normal suspension height.

# SWITCHES



**54. Suspension Third Axle Lift**  
Turn switch on to raise Third Axle.



**55. Tow Hook**  
Turn switch on to remove the slack from the Tow Hook.

## 56. Trailer Air Supply

The red octagon knob controls the air supply to the trailer.



**57. Trailer, Axle (3rd Axle) Lift**  
Turn switch on to lift 3rd Trailer Axle.



**58. Trailer, Axle Lift Forward**  
Turn switch on to lift Forward Trailer Axle.



**59. Trailer, Axle Lift Rear**  
Turn switch on to lift Rear Trailer Axle.



**60. Trailer, Belly Dump**  
Turn switch on to open Trailer Belly Dump.



**61. Trailer Dump Gate**  
Turn switch on to open Trailer Dump Gate.



**62. Trailer, Dump Gate Center**  
Turn switch on to open Trailer Center Dump Gate.



**63. Trailer, Dump Gate Front**  
Turn switch on to open Trailer Front Dump Gate.



**64. Trailer, Dump Gate Rear**  
Turn switch on to open Trailer Rear Dump Gate.



**65. Trailer Hotline**  
Turn switch on to supply electrical power to trailer accessories.



**66. Trailer, Suspension Air Dump**  
Turn switch on to deflate Trailer Air Suspension.



**67. Winch Clutch**  
Turn switch on to engage Winch Clutch.

## STEERING COLUMN

### Introduction

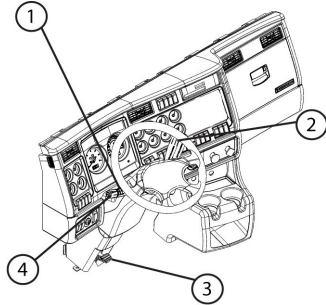

### Steering Column Controls

1. Turn Signal Lever
2. Trailer Brake Hand Valve (optional)
3. Tilt Steering Column Lever (optional)
4. Tilt Steering Column Lever (optional)

### Turn Signal/High Beam Switch

	NOTE
The ignition key must be turned to ON for the signal/switch to operate.	

The lever-action turn signal/high beam switch is located on the left side of the steering column. Each time a turn indicator is activated the buzzer emits a short beep.

### Turn Signals

- To signal a right turn, push the lever forward (clockwise).
- To signal a left turn, pull the lever back (counterclockwise).
- Each time the turn indicator is activated the audible warning emits a short beep.

# STEERING COLUMN

3

i	NOTE
	<p>If the vehicle turn signals and turn signal indicators in the dash gauge cluster ever begin flashing at an accelerated rate (115 cycles per minute) when the turn signal lever is in the OFF (center) position, or when a Right/Left turn has been selected, the problem may be related to a failed turn signal switch or turn signal module. In either case, the problem is not a failed bulb. Contact your nearest authorized Kenworth Dealer to have the problem corrected as soon as possible.</p>

▲	CAUTION
	<p>After you complete a turn, shut the system off by returning the lever to the "OFF" (center) position. The switch's lever action is NOT self-canceling. Failure to shut off a turn signal could confuse other drivers and result in an injury accident. An indicator light in the instrument panel will flash until the turn signal is turned off.</p>

## High Beam

i	NOTE
	<p>The headlights must be ON for the high beam switch to operate.</p>

- To switch your headlights to lower or higher beam, gently pull the turn signal lever, toward the steering wheel, until you hear the switch click and the beam changes. The blue indicator light in the instrument panel will be ON when the high beam is being used.
- To return to previous beam: pull the lever towards the steering wheel again.
- To momentarily flash your headlights (illuminating the high-beams), push the turn signal lever forward.

<b>i</b>	<b>NOTE</b>
<ul style="list-style-type: none"> <li>You cannot momentarily flash headlights when high beams are on. The headlights will flash on if they are off, if headlamps are on as low beams, headlamps dim to 25%.</li> <li>Headlight flash is not available on models with high intensity discharge (HID) headlight option.</li> <li>Check your local state's regulations for any restriction on the use of the high-beam flashing function.</li> </ul>	

## Windshield Wipers/Washer

Your Kenworth is equipped with a two-speed, intermittent windshield wiper system. A seven-position rotary wiper switch (located on the turn-signal lever) operates the windshield wipers and washer. Rotate the end of the turn signal lever to change the wiper mode.

<b>i</b>	<b>NOTE</b>
<p>The ignition key must be turned to ON or ACC for the wiper/washer switches to operate.</p>	

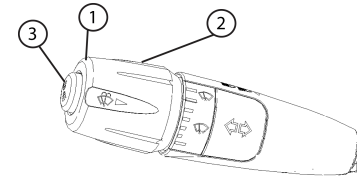

- 1 Press in for washer pump
- 2 Rotate to change wiper mode
- 3 Press button for Marker / ID Lamp flash

The first position after OFF is the intermittent #1 cycle. The next positions are intermittent #2, #3 and #4. The last two positions are wiper low speed and wiper high speed. See the wiper switch settings table for intermittent delay times.

<b>i</b>	<b>NOTE</b>
<p>The ignition key must be turned to ON or ACC for the wiper/washer switch to operate.</p>	

# STEERING COLUMN

## Wiper Switch Settings

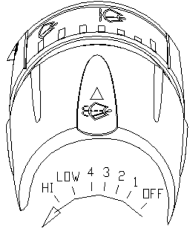

## To Wash the Windshield

Push the rotary wash/wipe knob in (towards steering column), hold for more than 0.8 seconds and then release. Hold the knob in to extend the washing cycle. After the lever is released, the wipers will shut off automatically or resume the wiper's setting speed.

To activate the wipers for one swipe without activating the washer ("mist" function), push the turn signal lever in (towards the steering column) and release in less than 0.5 seconds. The wipers will perform a single swipe and then resume the wiper's setting speed.

The windshield washer reservoir is located inside the engine compartment on the left side of the steering column. Check the windshield washing fluid level daily. If necessary, fill to top.



### WARNING!

Do not drive with worn or dirty wiper blades. They can reduce visibility, making driving hazardous. Clean blades regularly to remove road film and wax build-up. Use an alcohol based cleaning solution and a lint-free cloth, and wipe along the blades.



### CAUTION

If the electric pump is operated for a long period (more than 15 seconds) with a dry reservoir, the pump rotor may be damaged.

Clean all inside and outside windows regularly. Use an alcohol-based cleaning solution and wipe dry with either a lintfree or a chamois cloth. Avoid running the wiper blades over a dry windshield to prevent scratching the glass. Spray on washer fluid first.

Wiper Switch Position	Wiper Speed
Off	Off
Intermittent #1	20 Second Delay
Intermittent #2	17 Second Delay
Intermittent #3	7 Second Delay
Intermittent #4	4 Second Delay
Low	Low Speed
High	High Speed

### Trailer Brake Hand Valve

This hand valve, mounted on the steering wheel column, provides air pressure to apply the trailer brakes only. It operates independently of the foot treadle valve. See Using the Brake System on page 4-17, for more instructions on proper use of the Trailer Brake Hand Valve.

### Stop/Turn Signal Lamp Operation

Your Kenworth vehicle uses combined stop/turn signal lamps at the rear of the vehicle, using the same bulb to perform both functions. This means a single bulb is used for the brake lamp as well as the turn signal lamp. This bulb will burn steadily with the brakes applied. The same bulb will flash with the turn signal activated, even with the brakes applied.

### Maximum Number of Lamps Allowed per Circuit

- Vehicle Stop/Turn Signal Circuit

The lighting control unit is limited to 5 amps total, or two (2) 25 watt incandescent bulbs per side. Do not wire more than two incandescent bulbs per side to the vehicle tail lamp fixtures. If more than two bulbs are required for each tail lamp fixture, install LED type lamps, or contact your nearest Kenworth dealer for other options.

- Trailer Turn and Vehicle Forward Side Facing Turn Lamp Circuit

The lighting control unit is limited to 20 amps or nine (9) 25 watt incandescent bulbs total (per side) for the combination of trailer turn lamps and vehicle forward side facing turn lamps. Do not wire more than nine incandescent bulbs per side for the combination of trailer turn lamps and vehicle forward side facing turn lamps.

## STEERING COLUMN

---

If more than nine bulbs per side are required, install LED type lamps, or contact your nearest Kenworth dealer for other options.



### CAUTION

Before installing additional vehicle stop/turn lamps, trailer turn lamps or additional forward side facing turn lamps on the vehicle, make sure the lighting circuit limits described above are not exceeded. Exceeding the number of lamps designated above can/will cause the electronic control unit to default to a protection mode, causing the lamps to not function properly.

If you experience intermittent turn signal operation, the problem is either a short in the turn signal circuit or the maximum number of bulbs has been exceeded for the circuit.

If you experience any vehicle stop/turn signal issues, contact your nearest Kenworth dealer.

## Adjustable Tilt/Telescoping Column

The Adjustable Tilt/Telescoping Column is an option on your Kenworth. Depending on your vehicle's configuration, you may have a Tilt/Telescoping steering column or Fixed steering column. The tilt feature allows forward and rearward movement of the wheel. The telescoping feature allows you to move the wheel up and down. To activate these features, locate the Tilt/Telescoping pedal at the base of the steering column.

Similar to the headlamp system, if a problem is detected with the electronic control unit, the control unit will cycle the turn signals off once every 9 seconds. You can detect that this is occurring if the turn signal indicators in the dash operate intermittently.





## WARNING!

Do not adjust the Tilt-Telescoping Steering Wheel while the vehicle is in motion, it could cause loss of control. You would not be able to steer properly and could have an accident. Make all adjustments to the steering column while the vehicle is stopped. Failure to comply may result in personal injury, death, equipment or property damage.

### To tilt, raise or lower the Telescoping steering wheel:

- Push the pedal down fully. Move the wheel to the desired height and angle, then release the pedal to lock the wheel at the desired position.

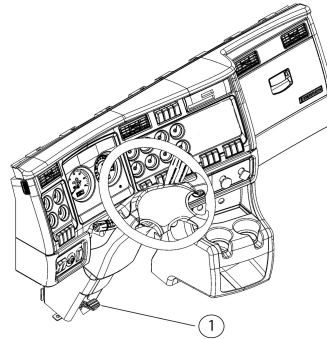

- 1 Tilt / Telescoping Steering Column Lever (optional)

## Horn

Your vehicle may be equipped with air horns. To operate, pull on the lanyard extending from the overhead header panel. Your vehicle may also have an electric horn. To sound the electric horn, press the button in the center of the steering wheel, which is the standard location for electric horns (optional horn locations may be requested).

# STEERING COLUMN

## SmartWheel Multiplex Control System



### CAUTION

Under no circumstances should you attempt to service the steering wheel, clockspring, or any of the electrical wiring in the multiplex system, or any steering components (steering column, steering driveline or steering gear). Tampering with these components may result in an inoperable multiplex system.

### System Description

The multiplex steering wheel system consists of the steering wheel mounted controls, the multiplex electronics module, the clockspring in the steering column and the interconnecting wire harnesses.

The steering wheel mounted controls tell the multiplex electronics module (located behind the dash) which electrical circuit to turn on or off. The controls are connected to the electronics module with two wires, using a "multiplexed" electronic signal. This multiplexed signal allows more than one switch to use the same pair of wires.

The multiplex electronics module contains relays and electronics to activate the circuits controlled by the steering wheel controls. These relays are not replaceable. The relays that control the headlights, marker lights

and horn are still located in the truck power distribution box. The electronics module is located between the dash switches and the relays, so that it can control them.

The clockspring in the steering column is a rotating electrical contact containing a wound electrical ribbon that lets "multiplexed" electrical signals to get from the steering wheel hub to the electronics module and still allow the steering wheel to turn. The clockspring is located at the top of the steering column directly beneath the steering wheel.

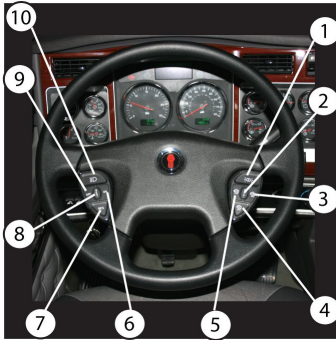

1. Marker Light "Flash"
2. Engine Retarder "Off"
3. Engine Retarder "Medium"
4. Engine Retarder "High"
5. Engine Retarder "Low"
6. Cruise Control "Coast"
7. Cruise Control "Resume"
8. Cruise Control "Set"
9. Cruise Control "Off"
10. Headlamp Flash

## Operating the System

### A. Horn

Depressing the bottom center bar activates the electric horn.

### B. Engine Retarder

These controls are located on the right-hand side of the steering wheel hub.



#### WARNING!

The service brakes must be used in an emergency. The engine or retarder alone might not stop you fast enough to prevent an accident. Relying only on the engine retarder, may result in personal injury, death, equipment or property damage.



#### WARNING!

The engine retarder is NOT intended as the primary brake for the vehicle, nor is it an emergency brake. The engine retarder only helps the service brakes by using engine pressure to slow the drivetrain. Use the service brakes for quick stops. Failure to comply may result in personal injury, death, equipment or property damage.



#### WARNING!

Do not operate the engine retarder when driving/operating your vehicle bobtail or with a loaded or unloaded trailer on road surfaces with poor traction (wet, icy, or snow covered roads) or in heavy traffic. Braking caused by the normal operation of the engine retarder could cause you to lose control of the vehicle and may result in personal injury, death, equipment or property damage.

# STEERING COLUMN

3

**i** NOTE

The exhaust brake and engine brake are two types of engine retarders. Refer also to the engine manufacturer's Operator Manual and to the Engine Retarder manual for additional instructions.

- **To Activate:**  
To activate the desired engine retarder setting:

Press  for LOW.

Press  for MEDIUM.

Press  for HIGH.

**i** NOTE

Your engine may only have 2 engine retarder settings, LOW and HIGH. If so, the MEDIUM button is non-operational.

- **To Turn Off:**

Press  for OFF.

## C. Cruise Control

These controls are located on the left-hand side of the steering wheel hub.

**⚠** WARNING!

Do not operate the cruise control when operating on road surfaces with poor traction (wet, icy, or snow covered roads) or in heavy traffic. Accelerations caused by the normal operation of the cruise control could cause you to lose control of the vehicle resulting in an injury accident.

- **To Turn On:**

Press the ON button.

- **To Turn Off:**

Press the OFF button. Any previous speed settings are cleared.

## Using Cruise Control While Driving

### Setting Cruise Speed

1. Ensure that the vehicle speed is above the minimum cruise control

speed and the engine speed is above 1100 rpm.

2. Press the "ON" button.
3. Accelerate the vehicle to the desired cruise speed.
4. Press the "SET" button to set the cruise speed.

	<b>NOTE</b>
Cruise Control may not hold the set speed going down hills. If the speed increases going down a hill, use the brakes to slow down. This will cancel Cruise Control.	

### Changing the Cruise Set Speed

- To **increase** the cruise set speed:

Press the "SET" button until the desired speed is achieved, then release the button.

- To **decrease** the cruise set speed:

Press the "RESUME" button and coast to the desired lower speed, then release the button.

### Cancelling Cruise Control

You can cancel cruise control in any of these ways:

- Tap the brake pedal.
- Tap the clutch pedal.
- Press the "OFF" button.

### Resuming Cruise Control

1. If you tapped the brake or clutch pedal, the cruise control remembered the previously set cruise speed. To resume that set speed, accelerate above the minimum cruise control speed and press the "RESUME" button.
2. If you pressed the "OFF" button or turned the ignition key OFF, this cleared the system memory and you will need to set a new cruise speed.

### Using Cruise Control for Stationary PTO Operation

#### Setting Idle Speed

1. Ensure parking brakes are applied.
2. Ensure transmission is in Neutral.
3. Engage PTO per the manufacturer's operating instructions.

# STEERING COLUMN

4. Press the "ON" button.
5. Press the "SET" button to obtain the desired engine rpm.

## Cancelling Cruise Control

You can cancel cruise control in any of these ways:

- Tap the brake pedal.
- Tap the clutch pedal.
- Press the "OFF" button.

## D. Headlight/Marker Lamp Flash

- **Headlight Flash:**

Press



located on the upper left corner of the steering wheel hub. The headlights will flash on if they are off, if headlamps are on as low beams, headlamps dim to 25%. This function is disabled on models with HID headlamp option. If headlamps are on high beams, high beams are deactivated, low beams are lit 25%. Headlamps return to low beam, not high beam.

- **Marker Lamp Flash:**

Press



to flash on the marker lamps if they are off, or blink off if they are on while the button is held down. This feature works with the marker lamp switch on the dash in either position. The button controls the trailer marker lamps (and the tractor marker lamps if they are on the same switch).

## MIRRORS

### Introduction

Your vehicle comes equipped with two outside rear view mirrors that enable you to see to the sides and behind your vehicle. Be sure both mirrors are adjusted properly before you begin driving.



#### WARNING!

Adjust all mirrors before driving. Adjusting the mirrors while driving can cause you to take your eyes off the road, which could result in an accident. Failure to do so could lead to serious injury or equipment damage.

To provide good visibility, adjust the mirror so the side of your vehicle appears in the inboard part of the mirror.



#### WARNING!

Convex mirrors can distort images and make objects appear smaller and farther away than they really are. You could have an accident if you are too close to another vehicle or other object. Keep plenty of space between your vehicle and others when you turn or change lanes. Remember that other objects are closer than they may appear.

### Power Mirror Switch

If your vehicle is equipped with power mirrors, the directional controls for both mirrors are located near the top of the driver side door trim pad.

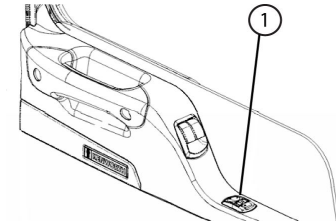

1. Power Mirror & Heated Mirror Controls

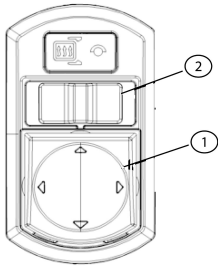

1. Mirror Directional Control Pad
2. Mirror Selector Switch

### To Adjust Kenworth Aerodynamic Style Mirrors

1. Move the mirror selector switch to the right or left from the neutral center position to select the desired mirror for adjustment.
2. Depress the mirror directional control pad in one of its four arrow directions to adjust the mirror in/out or up/down.

	<b>NOTE</b>
After mirror adjustments have been completed, return the mirror selector switch back to the center (neutral) position to prevent unintentional adjustments to the mirrors.	

### To Adjust Moto Mirrors

1. For in/out mirror adjustment: Move the mirror selector switch to the right or left from the neutral center position to select the desired mirror for adjustment.

	<b>NOTE</b>
If the mirror is fixed (non-motorized) on the left side, then the mirror selector switch will ONLY allow selection of the neutral and right mirror switch positions.	

2. Depress the mirror directional control pad towards the arrows

pointing left or right to adjust the mirror in/out.

	<b>NOTE</b>
Because the Moto mirrors have only 2-way adjustment, the mirror directional control pad is also restricted in its movement to left or right ONLY.	

	<b>NOTE</b>
After mirror adjustments have been completed, return the mirror selector switch back to the center (neutral) position to prevent unintentional adjustments to the mirrors.	



## Mirror Heat Button

Your Kenworth vehicle may be equipped with optional heated mirrors. Mirror heat is controlled by the mirror heat switch button, which is part of the mirror switch module located on the driver side door pad.

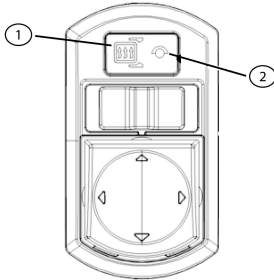

1. Mirror Heat Switch Button
2. Mirror Heat Indicator Light



**DRIVING TIPS AND TECHNIQUES**

Introduction . . . . . 4-5  
Coasting . . . . . 4-5  
Descending a Grade . . . . . 4-6  
Economical Driving . . . . . 4-6  
Fuel - Excess Consumption . . . . . 4-8  
Safe Driving . . . . . 4-10  
Cruise Control . . . . . 4-11  
Air Suspension Height/Air Pressure . . . . . 4-12  
Fifth Wheel. . . . . 4-14

**OPERATING THE BRAKE SYSTEM**

Introduction . . . . . 4-17  
Air Supply System . . . . . 4-18  
Using the Parking Brake . . . . . 4-20  
Vehicle/Trailer Air Supply Valve . . . . . 4-23  
Brake Safety and Emergency. . . . . 4-25  
Automatic Traction Control . . . . . 4-27

Anti-Lock Brake Systems (ABS) . . . . . 4-28  
Advanced ABS with Stability Control. . . . . 4-31  
Trailer Brake Hand Valve. . . . . 4-38  
Driving With an Unloaded Trailer . . . . . 4-39  
Engine Retarders . . . . . 4-39  
Exhaust Brake . . . . . 4-40  
Engine Brakes . . . . . 4-41  
Brake Components . . . . . 4-42

**OPERATING THE ENGINE**

Introduction . . . . . 4-44  
Starting Procedure - Normal Temperature . . . . . 4-45  
Starting Procedure - Cold Weather . . . . . 4-46  
Engine Block and Oil Pan Heater (Option) . . . . . 4-46  
Engine Warm-up . . . . . 4-47  
Ether Metering Equipment . . . . . 4-50  
Idling the Engine . . . . . 4-51  
Cruise Control . . . . . 4-52  
Engine Fan Control . . . . . 4-54

Engine Control Display . . . . . 4-55  
Engine Shutdown System . . . . . 4-55

**OPERATING THE REAR/DRIVE AXLE**

Introduction . . . . . 4-57  
Inter-Axle Differential Lock . . . . . 4-57  
Driver Controlled Main Differential Lock . . . . . 4-60  
Dual Range (Two-Speed) Rear Axle . . . . . 4-61  
Auxiliary Axles - Pusher or Tag . . . . . 4-63

**OPERATING THE TRANSMISSION**

Introduction . . . . . 4-70  
Transmission Warm-Up . . . . . 4-70  
Operating Manual Transmissions . . . . . 4-71  
Putting the Vehicle in Motion . . . . . 4-71  
More Transmission Tips . . . . . 4-74  
Operating Automatic Transmissions . . . . . 4-76  
Auxiliary Transmissions . . . . . 4-77  
Steerable Drive Axle . . . . . 4-77

**SHUT-DOWN**

Introduction . . . . .	4-78
Final Stopping Procedures . . . . .	4-78
Before Stopping the Engine . . . . .	4-79
Refueling . . . . .	4-80

## DRIVING TIPS AND TECHNIQUES

### Introduction

This section covers driving tips and techniques on how to drive your Kenworth efficiently. For further information on driving techniques, read the Truck Driver Handbook included in your glove box literature package. It will give you more tips on starting, shifting, and driving your vehicle.

### Coasting

Do not coast with the transmission in neutral or with the clutch pedal depressed.

 <b>WARNING!</b>
<p>Do not coast with the transmission in neutral or with the clutch pedal depressed, it is a dangerous practice. Without the use of the retarding power of the drivetrain, your vehicle can reach dangerous speeds. At very high speeds you may not be able to put the transmission in any gear. At high speeds you could seriously damage your vehicle or cause an accident when you put the transmission in gear. The engine speed could exceed the maximum governed speed and cause a serious accident due to mechanical failures. Failure to comply may result in personal injury, death, equipment or property damage.</p>

Besides being illegal and dangerous, coasting is also expensive. It causes premature failure or damage to the clutch and transmission and overloads the brake system.

Coasting with the transmission in neutral also prevents proper transmission component lubrication. During coasting the transmission is driven by the rear wheels, and the countershaft gear (which lubricates the transmission components by oil splash) will only be turning at idle speed.

### Descending a Grade



#### WARNING!

Do not hold the brake pedal down too long or too often while going down a steep or long grade. This could cause the brakes to overheat and reduce their effectiveness. As a result, the vehicle will not slow down at the usual rate. To reduce the risk of personal injury and/or an accident, before going down a steep or long grade, reduce speed and shift the transmission into a lower gear to help control your vehicle speed. Failure to follow procedures for proper downhill operation could result in loss of vehicle control and may result in personal injury, death, equipment or property damage.

### Economical Driving

The following section includes recommendations for best engine performance and economy:

### Engine Overspeed - RPM

- Operate the engine within the optimum engine RPM range and do not allow the RPM's to exceed the maximum governed speed. See your Engine Operation and Maintenance manual for information regarding engine RPM.
- When the engine is used as a brake to control vehicle speed (e.g., while driving down a grade), do not allow the engine RPM to exceed maximum governed speed.
- Under normal load and road conditions operate the engine in the lower end of the range.



	<b>NOTE</b>
Often these recommendations are secondary to maintaining an adequate and safe speed relative to the surrounding traffic and road conditions.	

	<b>CAUTION</b>
To avoid engine damage, do not let the engine RPM go beyond the maximum governed RPM valve damage could result if overspeed conditions occur.	

### Use of Tachometer

The tachometer is an instrument that aids in obtaining the best performance of the engine and manual transmission, serving as a guide for shifting gears. Refer to the Engine Operation and Maintenance manual for optimum engine RPM.

- If the engine RPM moves beyond the maximum governed speed, indicating an overspeed condition, apply the service brake or shift to a higher gear to bring engine RPM within the optimum speed range.
- When driving downhill: shift to a lower gear, use the engine brake (if so equipped), and use the service brake, keeping the engine speed below 2,100 rpm.

When the engine speed reaches its maximum governed speed, the injection pump governor cuts off fuel to the engine. However, the governor

has no control over the engine RPM when it is being driven by the vehicle's transmission, for example, on steep downgrades. Apply service brakes or shift to a higher gear.

## DRIVING TIPS AND TECHNIQUES

---

4

**Fuel economy and engine performance are also directly related to driving habits:**

- The best results in trip time and fuel economy are obtained while driving the vehicle at a steady speed.
- Shift into higher or lower gears (or apply the service brake) to keep engine RPM near the lower end of the optimum operating range.
- Avoid rapid acceleration and braking.

### **Fuel - Excess Consumption**

The vehicle's fuel consumption is connected to three important factors: maintenance, driving habits, and general condition of the road, traffic conditions, and vehicle load.

### **Maintenance**

Proper maintenance will keep the vehicle running like new even after long periods of use. The driver must perform the daily and weekly checks of the vehicle.

#### **Maintenance factors affecting fuel consumption:**

- air and/or fuel filters partially clogged
- engine valves out of adjustment
- injection pump improperly synchronized
- injection nozzles defective or uncalibrated
- improperly inflated tires
- wheel bearings improperly adjusted

- clutch improperly adjusted or worn (slipping)
- fuel leaks

### Driving Habits

Wrong driving habits must be corrected and the recommendations on economic driving should be followed.

### Driving factors affecting fuel consumption:

- excessive speed and unnecessary fast acceleration
- long periods of idling
- driving with foot resting on the (manual transmission) clutch pedal

### General Condition

Other factors affecting fuel consumption are related to loads and type of roads on which the vehicle operates. It is not always possible to choose the most adequate road, but it must be kept in mind that the ideal road is the one that allows a steady speed in high gear, without requiring frequent braking and acceleration.

### The following general conditions can affect fuel consumption:

- overload
- unbalanced load
- very high load
- inadequate roads
- traffic conditions

# DRIVING TIPS AND TECHNIQUES

---

## Safe Driving

	NOTE
The following recommendations are merely informative and do not cover all safety precautions. Safe driving is, above all, the responsibility of the driver.	

The safe operation of a vehicle is not just following the established traffic rules, but should also include: maintaining the vehicle in good mechanical condition, and proper operation of the engine, transmission, and brakes.

### The following guidelines will help you to drive the vehicle safely:

- Make a thorough inspection of the vehicle, daily and weekly. See Driver's Check List on page 1-28.
- Ensure that windows, mirrors, and lights are clean.
- Check all tires for damage and correct inflation pressure.
- Adjust the seat to a comfortable driving position, for easy access to pedals and vehicle controls.
- Adjust rear view mirrors.
- Always use the safety belts.
- Do not exceed the GVWR.
- Proportionally distribute loads on the frame.
- Always keep the brakes adjusted and in proper condition. See Checks and Adjustments on page 5-51.

- Obey speed limits and all traffic signals.
- When driving downhill, select one gear lower than the up-hill gear. And use the brakes properly, do not ride them.
- Do not exceed maximum governed speed (as specified in the Engine Operation and Maintenance Manual).

 <b>WARNING!</b>
Do not exceed the specified load rating. Overloading can result in loss of vehicle control and personal injury, either by causing component failures or by affecting vehicle handling. Exceeding load ratings can also shorten the service life of the vehicle. Failure to comply may result in personal injury, death, equipment or property damage.

- The components of your vehicle are designed to provide satisfactory service if the vehicle is not loaded in excess of either the gross vehicle weight rating (GVWR), or the maximum front and rear gross axle weight ratings (GAWRs). (Axle weight ratings are listed on the driver's door edge.)

 <b>NOTE</b>
For your safety and the safety of others, follow routine and periodic maintenance schedules for all components on your vehicle. See Table 9, Maintenance Schedule on page 5-16.

## Cruise Control



This feature can improve fuel mileage and can reduce driver fatigue by maintaining a constant vehicle speed.

 <b>WARNING!</b>
Do not operate the cruise control when operating on road surfaces with poor traction (wet, icy, or snow covered roads) or in heavy traffic. Accelerations caused by the normal operation of the cruise control could cause you to lose control of the vehicle and may result in personal injury, death, equipment or property damage.

## DRIVING TIPS AND TECHNIQUES



### NOTE

Cruise control functions and features may vary depending upon which engine is installed in your Kenworth. For specific instructions on operating the cruise control, see the Engine Operation and Maintenance Manual.



### NOTE

Cruise Control will not function until the operator has depressed both the service brake pedal and the clutch pedal at least one time after each start-up. For vehicles with automated transmissions and no clutch pedal, only the service brake pedal needs to be depressed.

## Air Suspension Height/Air Pressure



Your vehicle may have an air suspension and a deflation switch which allows the air in the suspension to be exhausted from a switch on the dash. The normal purpose of this feature is to allow you to lower the vehicle for loading.

A guard on the switch prevents you from accidentally deflating the suspension.



### CAUTION

Operating a vehicle with air suspension bags either overinflated or under-inflated may cause damage to driveline components. If a vehicle must be operated under such conditions, do not exceed 5 mph (8 km/h). Failure to comply may result in equipment damage.

### Suspension Air Pressure Gauge

The Suspension Air Pressure gauge (option), see Optional Gauges on page 3-64, which indicates the amount of air pressure in the air suspension springs in pounds per square inch (psi). Air pressure in the spring is related to the rear axle load. The greater the rear axle load, the greater the air pressure in the air bags. Therefore, the air pressure displayed will vary, depending upon the rear axle load.

### Driving with Deflated Air Springs

If an air spring ruptures, there will be enough air pressure to drive the vehicle to a safe stop off the highway to investigate the problem.

### To get to a repair facility, do the following:

1. Remove the height control link connected to the axle and to the suspension air valve control arm. This will cause the air valve control arm to center in the closed position.
2. The air system can then be pumped up to normal pressure for continued operation.

## DRIVING TIPS AND TECHNIQUES

---

4



### WARNING!

Low air pressure could make brakes unsafe for driving by not providing sufficient air brake application pressure in an emergency, which could lead to an accident. Before driving the vehicle, make sure the air pressure pumps up to over 100 psi (689 kPa) for normal brake operation. If it does not reach 100 psi (689 kPa), do not try to move the vehicle. Failure to comply may result in personal injury, death, equipment or property damage.

### Fifth Wheel

The following applies to tractor configurations:



### WARNING!

Ensure that all fifth wheel maintenance, adjustments, and rebuilding are done only by a qualified mechanic. An improperly maintained fifth wheel can cause a trailer to separate from a tractor. This could lead to a serious accident. Failure to comply may result in personal injury, death, equipment or property damage.

locking dogs as the tractor is backed under a trailer.

Your Kenworth T440/T470 is equipped with either a Fixed or an Air-Controlled Sliding Fifth Wheel. Either type should self lock when a trailer king pin trips the



### Fifth Wheel Jaw Lock

#### To unlock the fifth wheel lock:

- Pull out on the lever (usually located on the left-hand side of the fifth wheel) until it remains in an over center position.

#### Hook Up:

- After connecting your tractor to the trailer, always inspect the jaws to be sure they have locked on the kingpin before driving.

### Air-Controlled Sliding Fifth Wheel



Vehicles having an air-controlled sliding fifth wheel have a fifth wheel slider lock controlled by a switch on the accessory switch panel. To operate this type of lock, move the switch to the appropriate position. By placing the switch in the UNLOCK position, you can slide the fifth wheel to various positions to adjust weight distribution. There is a guard on this switch to protect you against accidentally activating or releasing the lock.



#### WARNING!

Do not move the fifth wheel while the tractor-trailer is in motion. Your load could shift suddenly, causing you to lose control of the vehicle, which can result in an accident. Never operate the vehicle with the switch in the UNLOCK position. Always inspect the fifth wheel after you lock the switch to be sure the fifth wheel lock is engaged. Failure to comply may result in personal injury, death, equipment or property damage.

## DRIVING TIPS AND TECHNIQUES

---

### Fifth Wheel Lubrication

- Frequently operate and lubricate movable or sliding fifth wheels to prevent corrosion.



#### CAUTION

Both the fifth wheel plate and the slide tracks (if a slider) should be cleaned and lubricated periodically to ensure smooth turning and sliding action. Failure to keep these surfaces lubricated can lead to frame or driveline damage.

4

See Frame and Fifth Wheel on page 5-99, for maintenance information.

# OPERATING THE BRAKE SYSTEM

## Introduction

The operation of the vehicle's braking system and many vehicle accessories depends upon the storage and application of a high-pressure air supply.

This air brake system is of the dual circuit type: it has a circuit for the front wheels, a separate circuit for the rear wheels, and one for the trailer. The system is supplied by an engine-driven compressor. The vehicle's compressor takes outside air and compresses it, usually to 100-130 psi (689-896 kPa). The compressor air then goes to the air tanks to be stored until needed.

When you operate your air brakes, the stored compressed air flows into the chambers where it is used to apply your truck and trailer brakes. That

is why, when you push down on the brake pedal, you do not feel the same amount of pressure on the pedal that you do when you apply the brakes on your car. All you are doing on your truck is opening an air valve to allow air to flow into the brake chambers.

	<b>WARNING!</b>
<p>The brake system is a critical vehicle safety system. For the safety of you and others around you, have the vehicle submitted for periodic preventive maintenance checks as well as having any suspected problems immediately checked by an authorized Kenworth Dealer. Failure to properly maintain your brake system can lead to serious accidents. Failure to comply may result in personal injury, death, equipment or property damage.</p>	

	<b>WARNING!</b>
<p>Never drive your vehicle with the parking brake applied. Always release the parking brakes prior to moving the vehicle. Failure to disengage the parking brakes prior to moving your vehicle could result in excessive heat buildup in the brake system, resulting in a fire. Failure to comply may result in personal injury, death, equipment or property damage.</p>	

	<b>NOTE</b>
<p>Today's diesel electronic engines have significant torque and startability power at low RPM. Combinations of engine speed and available torque may over-power the vehicles parking brakes.</p>	

# OPERATING THE BRAKE SYSTEM

## Air Supply System

Contamination of the air supply system is the major cause of problems in air-operated components such as brake valves and suspension height control valves. To keep contaminants to the lowest possible level, follow all maintenance procedures.

## Air Dryer

### Bendix AD-IS Series Air Dryers

 <b>WARNING!</b>	
If a different air dryer brand or model is installed on the vehicle other than what was originally installed, it could cause the air system to not perform correctly unless the full air system design is reviewed and modifications made to comply with Federal Motor Vehicle Safety Standards (FMVSS 121 - Air Brake Systems) or, in the case of chassis equipped with the European air system, ECE R13. Failure to abide by this warning and maintain compliance to FMVSS 121 or ECE R13 could cause loss of vehicle control and may lead to personal injury or death.	

Your Kenworth vehicle may be equipped with a Bendix AD-IS series air dryer. Any air dryer replacement

should be made with an identical component.

The AD-IS Series air dryer has incorporated into its design various components that have typically been installed separately on the vehicle (see below for components/ areas affected).

- Pressure protection valves
- Safety valve
- Governor and plumbing
- Plumbing of the front and rear service air tanks
- Plumbing to accessory systems

These components are required to meet the Federal Motor Vehicle Safety Standards (FMVSS 121 - Air Brake Systems) or, in the case of chassis equipped with the European air system, ECE R13. As the Warning above states, any other type of air dryer installed in the place of an

AD-IS Series will require changes, modifications, and/or additions to your vehicle's air system to maintain compliance with FMVSS 121 or ECE R13. Kenworth strongly recommends that if the air dryer is changed from an AD-IS series, you consult your nearest authorized Kenworth dealer.

**Brake Operation**

 <b>WARNING!</b>
Do not drive through water deep enough to wet brake components, as it may cause the brakes to work less efficiently than normal. The vehicle's stopping distance may be longer than expected, and the vehicle may pull to the left or right when brakes are applied, which could contribute to an accident. Failure to comply may result in personal injury, death, equipment or property damage.

To rectify this condition, check the rear and both sides of the vehicle for clear traffic, then apply the brakes gently, releasing and gently reapplying until the brakes dry out, restoring normal operation. Always check brakes after driving through deep water to help reduce the possibility of personal injury or an accident.

**Front Brake System**

When the brake pedal is depressed, the front circuit portion of the treadle valve delivers air from the front service air tank to the front axle brake chambers via a quick-release valve.

Simultaneously (on full truck configurations), air is also supplied to the modulating valve control port. In the event of a rear service circuit failure, the modulating valve will exhaust air from the spring brake chambers, applying the spring brakes in proportion to the front circuit application.

# OPERATING THE BRAKE SYSTEM

## Rear Brake System

When the brake pedal is depressed, the rear circuit portion of the treadle valve delivers air from the rear service air tank to the service brake relay valve control port. The relay valve then delivers air directly from the rear service air tank to the rear brake chambers in proportion to the treadle pressure.

## Using the Parking Brake

The yellow diamond-shaped knob on the dash controls the vehicle parking brakes. These are spring brakes that you activate by releasing air pressure from their chambers. When they are not in use, air pressure compresses the springs and releases the brakes. Pulling the valve OUT applies the parking brake, which exhausts air from the chambers and allows the springs to extend and apply the brakes.

 <b>WARNING!</b>
Do not leave the cab without applying the parking brake. The vehicle could roll and cause an accident. Always apply the parking brake before you leave the cab. Failure to comply may result in personal injury, death, equipment or property damage.

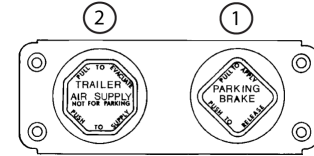

Combination ( Vehicle/Trailer) Parking Brake Control Valves

- 1 Parking Brake Control (Yellow)
- 2 Trailer Air Supply Control (Red)

### Before you leave the cab:

1. Apply all parking brakes. Pull out the **Yellow** Parking Brake Control knob (1) located on the dash. The **Red** (octagon-shaped) Trailer Air Supply Control knob will automatically pop out. (A dash warning light will indicate when the brake is ON.)
2. Shift the transmission into PARK position:
  - manual transmission, select First or Reverse gear.
  - automatic transmission, select Neutral.
3. Turn the key to OFF.
4. Remove the key.

 <b>WARNING!</b>
Do not pull out the parking brake valve while the vehicle is moving. Stopping with the parking brake controls can cause a sudden wheel lock-up, loss of control, or over-take by following vehicles. Failure to comply may result in personal injury, death, equipment or property damage.

The parking brakes act on the rear wheels only. They are spring-applied, with air pressure used to release them. Release air is supplied by both the front and rear circuit air tanks through a double check valve.

### To release the vehicle parking brakes ONLY:

- Push IN the **Yellow** knob on the dash. Your trailer will remain parked.
- Below 60 psi (414 kPa) the **Yellow** parking brake valve remains OUT (ON position). If air pressure is not restored above 60 psi (414 kPa), the knob will automatically return to the OUT position if you attempt to push it in. See Primary and Secondary Air Pressure on page 3-63.

## OPERATING THE BRAKE SYSTEM

---

### To release the trailer brakes ONLY:

- Push IN the **Red** knob on the dash. The vehicle will remain parked.

### To release the full combination of brakes:

- Push IN **BOTH** knobs on the dash.
- In the event that air pressure is reduced below a safe level: the low air warning light will come on first; if air pressure continues to drop, the parking brake valve will pop OUT, automatically applying the spring brakes.



### CAUTION

Do not try to put the vehicle in motion before pressure in the system reaches 100 psi (689 kPa) because the wheels are locked by the spring brake action. Unnecessary stress and possible brake malfunction could occur if the vehicle is forced to move before the air system reaches 100 psi (689 kPa). Failure to comply may result in equipment damage.



### WARNING!

If the air pressure falls below 60 psi (414 kPa) the spring brakes may stop the vehicle abruptly, which could result in an accident. Observe the red warning lamps on the gauges. If one comes on, do not continue to drive the vehicle until it has been properly repaired or serviced. Failure to comply may result in personal injury, death, equipment or property damage.





### WARNING!

Do not use the trailer hand brake or service brakes to park and hold an unattended vehicle, use the parking brakes. Because service brakes work with air pressure, these brakes could slowly release. Your vehicle could roll, causing a serious accident. Never rely on the service brakes to hold a parked vehicle. Failure to comply may result in personal injury, death, equipment or property damage.

### Vehicle/Trailer Air Supply Valve

#### Initial Charge

The red octagon knob controls the air supply to the trailer. With the system completely discharged, both the **Red** (trailer air supply) and the **Yellow** (parking brake) knobs are OUT; thus, vehicle and the trailer parking (spring) brakes are applied.

#### To supply air to the trailer system and release the trailer parking brakes:

1. Allow the vehicle air system pressure to build up to operating level.
2. When system pressure reaches 50 psi (345 kPa) the **Red** knob may be pushed IN.

3. Hold the **Red** knob IN by hand until the trailer air pressure builds to a pre-set level, about 45 psi (310 kPa). At this point it will remain in, charging the trailer system and releasing only the trailer brakes.
4. The **Yellow** knob will remain OUT (vehicle brakes ON).

#### Normal Run Position

- The **Yellow** knob (system park) may now be pushed IN, which will supply air to the vehicle spring brakes, releasing them.

# OPERATING THE BRAKE SYSTEM

## Trailer Park or Emergency Brake Application Only

If you ever have a failure or disconnect the air supply hose to the trailer, the trailer parking brakes will set. The **Red** knob will automatically pop OUT and seal off the vehicle air tanks to protect the vehicle air system pressure.

### To apply the trailer brakes only:

Pull OUT the **Red** knob. This will exhaust air from the trailer supply line, causing the vehicle protection valve to close and the trailer spring brakes to apply. The trailer is now in emergency or park. This mode would be used to uncouple from the trailer (running without a trailer connected).



### WARNING!

Do not use the trailer hand brake or service brakes to park and hold an unattended vehicle, use the parking brakes. Because service brakes work with air pressure, these brakes could slowly release. Your vehicle could roll, causing a serious accident. Never rely on the service brakes to hold a parked vehicle. Failure to comply may result in personal injury, death, equipment or property damage.

4

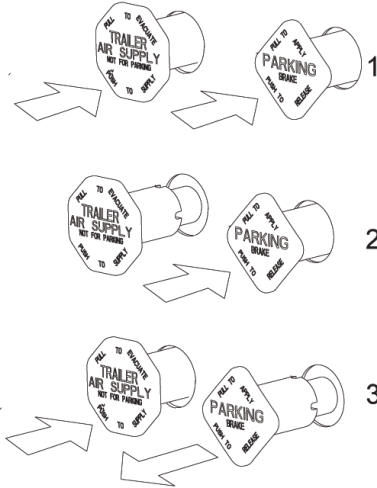

1. Normal Run Position
2. Trailer Park with Vehicle Released
3. System Park or Trailer Charge with Vehicle Parked

## System Park

With both knobs pushed in for normal operating modes, the parking brakes of both the vehicle and the trailer may be applied by pulling the **Yellow** knob OUT. This will exhaust the air from the vehicle spring brakes, and simultaneously cause the **Red** knob to pop OUT, which will apply the trailer brakes. This complies with the Federal Motor Vehicle Safety Standards (FMVSS) 121 requirement that one control should apply all the parking brakes on the vehicle.

## Trailer Charge

If both knobs are OUT (combination vehicle is parked), and it is desired to recharge the trailer, the **Red** knob may be pushed IN repressurizing the trailer supply line. The vehicle will remain parked. For more information on air supply pressure requirements, see Initial Charge on page 4-23.

## Brake Safety and Emergency

	<b>WARNING!</b>
<p>Do not operate the vehicle in the event of a malfunction in any air circuit. The vehicle should not be operated until the system is repaired and both braking circuits, including all pneumatic and mechanical components, are working properly. Loss of system air can cause the service brakes to not function resulting in the sudden application of the spring brakes causing wheel lock-up, loss of control, or overtake by following vehicles. Failure to comply may result in personal injury, death, equipment or property damage.</p>	

- If pressure is lost in the vehicle front or rear circuit, the "check" valves isolate the unaffected circuit, allowing this circuit to continue normal operation. The trailer brakes are still functional.

## OPERATING THE BRAKE SYSTEM

4

- If air pressure is lost in the trailer supply/park circuit, and the pressure drops below 60 psi (414 kPa), the trailer spring brakes are automatically applied, and the vehicle air pressure circuits are unaffected.
- If air pressure is lost in the trailer brake service circuit, and the pressure in the vehicle front and rear circuits drops below 60 psi (414 kPa), the vehicle and trailer spring brakes are automatically applied.

### Emergency Braking

 <b>WARNING!</b>
Unless you have an anti-lock braking system (ABS), always avoid completely depressing the service brake pedal, if possible, even during emergency braking. Depressing the brake pedal too aggressively can cause the wheels to lock, which can lead to an uncontrolled skid and can result in an accident. Failure to comply may result in personal injury, death, equipment or property damage.

**For Non-ABS Vehicles:** to stop your vehicle in an emergency, vary the service brake application pressure to provide maximum braking force without locking the wheels. Use engine compression to assist the service brakes by not depressing the clutch pedal until the engine reaches idle speed.

### Overheated Brakes

Under normal braking conditions, the energy generated will bring the internal brake drum temperature to about 500° F (260° C). This is well within the safe zone: the maximum safe temperature of lining for drum type brakes is usually about 800° F (427° C).

If service brakes are used for emergency braking, used improperly, or for prolonged periods, internal brake drum temperatures may exceed 800° F (427° C). Such brake overheating may be detected by a burning smell or smoke coming from a drum. If this occurs, you should immediately stop and check for cracked brake drums or lining fires. If neither exists, continue driving and resume a slow speed as soon as possible to cool the brakes. If the vehicle was to remain stopped, the heat transfer could destroy the linings and distort the brake drum.

### To prevent drums from distortion while they cool down:

- Park the vehicle on level surface and block the wheels.
- Release the parking brake and allow the brakes to cool down. See Parking Brake Valve on page 3-94.

### Automatic Traction Control

General information on ABS and automatic traction control.



Your truck/tractor ABS is equipped with an automatic traction control (ATC) feature. This feature is controlled by a switch on the dash. Do not allow the traction control lamp to remain on continuously for an extended length of time. Extended continuous use of the ATC can cause overheating of the drive wheel brakes. Engine torque or vehicle speed should be reduced to eliminate wheel spin and prevent excessive application of the ATC system. Except for checking for proper illumination of the ABS and traction control warning lamps when first starting the vehicle, and for monitoring

these lamps while driving, no special operating procedures are required. For detailed system description, see literature for your specific ABS that was provided with your vehicle.

# OPERATING THE BRAKE SYSTEM

## Anti-Lock Brake Systems (ABS)

Information on using the anti-lock brake system.

This vehicle is equipped with an anti-lock braking system (ABS). ABS reduces the possibility of wheel lock-up. If a wheel is about to lock during braking, the ABS will automatically adjust air pressure to the brake chambers on the appropriate wheel(s) to prevent wheel lock-up. The ABS is automatically turned on when the ignition switch is turned on.



### WARNING!

The Anti-Lock Brake System is a critical vehicle safety system. For the safety of you and others around you, have the vehicle submitted for periodic preventive maintenance checks as well as having any suspected problems immediately checked by an authorized dealer. Failure to properly maintain your brake system can lead to serious accidents. Failure to comply may result in death, personal injury, equipment or property damage.



### WARNING!

Do not rely on an anti-lock brake system that is functioning improperly. You could lose control of the vehicle resulting in a severe accident, causing death or personal injury. If your ABS lamp goes on while you are driving or stays on after the self-check, your anti-lock system might not be working. The ABS may not function in an emergency. You will still have conventional brakes, but not anti-lock brakes. If the lamp indicates a problem, have the ABS checked.

Vehicles without ABS are typically equipped with a bobtail brake proportioning system. When a trailer is not connected, the drive axle brake application pressure will automatically be limited by the proportioning system. When driven in a bobtail mode, these tractors will require greater

brake pedal application to provide the equivalent braking to a bobtail tractor not equipped with a proportioning system.

**Trailer ABS Power Line Communication (PLC)**

North American on-highway vehicles are equipped with a separate electrical circuit to power the ABS on towed vehicle(s). In most cases, the ABS power will be supplied through the Auxiliary circuit on the primary 7-way trailer light line connector. If the vehicle was manufactured with a switchable Auxiliary circuit for trailer accessories, an additional 7-way connector would have been provided for trailer ABS power. In either case, the ABS power line on the vehicle will be PLC equipped.

	<b>CAUTION</b>
Do not splice into the non-switchable Auxiliary circuit on the primary 7-way trailer light line. Doing so may cause the trailer ABS to malfunction. This circuit is dedicated for trailer ABS power. To add a switchable auxiliary circuit, contact a dealership.	

	<b>NOTE</b>
Tractors/Trucks and trailers built after 03/01/2001 must be able to turn on an In-Cab Trailer ABS Warning Lamp (per U.S. FMVSS121). The industry chose Power Line Communication (PLC) as the standard method to turn it on. On trailers built prior to 03/01/2001, verify trailer ABS status via the required external warning lamp mounted on the trailer. The indicator lamp on the trailer should be yellow and identified with the letters ABS.	

## OPERATING THE BRAKE SYSTEM

4

For doubles or triples, the lamp does not distinguish between trailers. An ABS problem in any of the trailers will activate the Trailer ABS Warning Lamp.

If you change the intended service in any way (e.g., number of axles, multiple trailers, add switchable trailer accessories, etc.) from the date the vehicle was manufactured, you should contact your trailer manufacturer and/or trailer anti-lock brake manufacturer to determine if the power available at the 7-way trailer light line is adequate. Failure to do so might result in insufficient power to the trailer ABS, which may affect its operation.



### CAUTION

The center pin of the 7-way trailer light line may be constantly powered for ABS. Make sure it will not accidentally turn on trailer equipment.

### Special Trailer ABS (Without PLC) Option

If a trailer does not have PLC, but it does have ABS that is powered through an optional second trailer connector (ISO 3731) and that trailer ABS is designed to control the Trailer ABS Warning Lamp in the cab and the vehicle has been ordered with the option to turn on this lamp for these types of trailers, then this lamp will turn on when that trailer ABS has a problem. This should be checked by a dealer as soon as possible. The Trailer ABS Warning Lamp will not turn on for the power-on test when connected to these types of trailers.



### NOTE

Very few trailers built before 03/01/2001 have this option. Trailers built after 03/01/2001 are built with PLC technology.



### Advanced ABS with Stability Control

What you need to know about your vehicle's braking, traction, and stability control features.

Electronic Stability Control is a feature that reduces the risk of rollovers, jackknifing, and other loss of control situations. ESC features include Roll Stability Program (RSP) and Yaw Control.

During operation, the ABS ECU constantly compares performance models to the vehicle's actual movement, using the wheel speed sensors of the ABS, as well as lateral, yaw, and steering angle sensors. If the vehicle shows a tendency to leave an appropriate travel path, or if critical threshold values are approached, the system will intervene to assist the driver.



ESC may reduce the vehicle speed automatically. To minimize unexpected deceleration and reduce the risk of a collision the operator must:

- Avoid aggressive driving maneuvers, such as sharp turns or abrupt lane changes at high speeds, which might trigger the stability system.
- Always operate the vehicle safely, drive defensively, anticipate obstacles and pay attention to road, weather, and traffic conditions. ABS, ATC, and ESC systems are no substitute for prudent, careful driving.

### Roll Stability Program

The Roll Stability Program (RSP), an element of the overall ESC system, addresses rollover conditions. In the case of a potential roll event, the ECU will override the throttle and quickly apply brake pressure at all wheel ends to slow the vehicle combination. The level of braking application during an RSP event will be proportional to roll risk.

# OPERATING THE BRAKE SYSTEM

## A Real World Example of How the RSP System Operates

Excessive speed for road conditions creates forces that exceed the threshold at which a vehicle is likely to rollover on a higher-friction surface. The system automatically reduces engine torque and applies the service brakes (based on the projected rollover risk) to reduce the vehicle speed, thereby reducing the tendency to roll over.

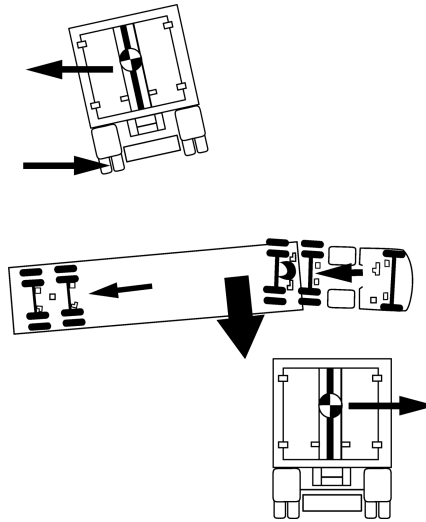

RSP Example

## Yaw Stability

Yaw stability counteracts the tendency of a vehicle to spin about its vertical axis. During operation, if the friction between the road surface and the tires is not sufficient to oppose lateral (side) forces, one or more of the tires can slide, causing the truck/tractor to spin.

These yaw events are referred to as either "under-steer" (where there is a lack of vehicle response to steering input due to tire slide on the steer axle) or "over-steer" (where the tractor's rear end slides out due to tire slide on the rear axle) situation. Generally, shorter wheelbase vehicles (tractors, for instance) have less natural yaw stability, while longer wheelbase vehicles (straight trucks, for instance) have greater natural yaw stability. Factors that influence yaw stability are: wheelbase, suspension, steering geometry, weight distribution front to rear, and vehicle track width.

## Yaw Control

Yaw Control responds to a wide range of low- to high-friction surface scenarios including rollover, jackknife and loss of control. In the case of vehicle slide (over-steer or understeer situations), the system will reduce the throttle and then brake one or more of the "four corners" of the vehicle (in addition to potentially applying the trailer brakes), thus applying a counter-force to better align the vehicle with an appropriate path of travel. For example, in an over-steer situation, the system applies the "outside" front brake; while in an under-steer condition, the "inside" rear brake is applied.

### A Real World Example of How Yaw Control Operates

Excessive speed exceeds the threshold, creating a situation where a vehicle is likely to spin and jackknife.

The Yaw Control system reduces engine throttle and selectively applies brakes to reduce the vehicle speed, thereby reducing the tendency to jackknife.

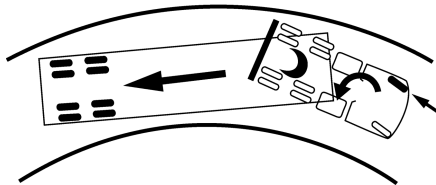
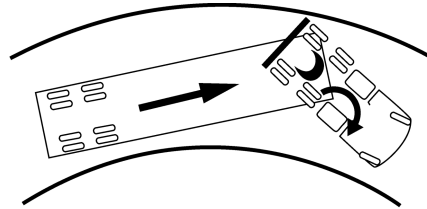

Yaw Control Example

## Automatic Traction Control

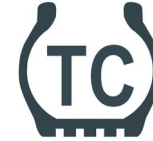

Your truck/tractor ABS has an automatic traction control (ATC) feature. This feature is controlled by a switch. This feature is monitored by a warning lamp located on the switch. The Traction Control warning lamp will briefly illuminate and then go out when the ignition switch is first turned on. The traction control warning lamp will illuminate whenever the ATC system detects drive wheel spin. The lamp will remain illuminated as long as wheel spin is detected and the ATC system is applying the drive wheel brakes or reducing engine torque. Engine torque or vehicle speed should be reduced to eliminate wheel spin and prevent excessive application of the ATC system.

## OPERATING THE BRAKE SYSTEM

---

4

Except for checking for proper illumination of the ABS and traction control warning lamps when first starting the vehicle, and for monitoring these lamps while driving, no special operating procedures are required. For detailed system description, see literature for your specific ABS that was provided with your vehicle.

This feature helps improve traction when vehicles are on slippery surfaces or surfaces with poor traction (i.e. mud or snow) by reducing drive wheel overspin. Automatic traction control works automatically in two different ways:

- If a drive wheel starts to spin, ATC applies air pressure to brake the wheel. This transfers engine torque to the wheels with better traction.

- If all drive wheels spin, ATC reduces engine torque to provide improved traction.

ATC turns itself on and off, you do not have to select this feature. If drive wheels spin during acceleration, the ATC Warning Lamp comes on, indicating wheel spin control is active. Do not allow the ATC Warning Lamp to remain on continuously for an extended length of time. Extended, continuous use of the ATC can cause overheating of the drive wheel brakes.

### Deep Snow and Mud Switch

A deep snow and mud switch is included with ATC. The Deep Snow and Mud feature is helpful during acceleration. This function increases available traction on extra soft surfaces like snow, mud or gravel, by slightly increasing the permissible wheel spin. When this function is in use, the ATC Warning Lamp blinks continuously.

**Off-Road ABS Function Switch (option)**

Your vehicle may be equipped with a separate switch to activate an Off-Road ABS function. This function is NOT to be used for On-Highway driving but is intended to be used to improve stopping performance in Off-Highway conditions (e.g., loose gravel and mud). The Off-Road ABS function is accomplished by allowing a "wedge" of material to build-up in front of momentarily locked wheels.

1. Changes the ABS control limits to allow for a more aggressive ABS function while off-road.
2. Improves vehicle control and helps reduce stopping distances in off-road conditions or on poor traction surfaces such as loose gravel, sand, and dirt.
3. Allows retarders to function independently of the ABS function.

4. If your vehicle does not have an engine retarder, the Off-Road ABS switch will function the same.

 <b>WARNING!</b>
While the off road mode can improve vehicle control and shorten stopping distances, some steering ability may be reduced on certain surfaces resulting from the momentarily sliding tires. Always operate your vehicle at safe operating speeds. Failure to do so may cause you to lose control of the vehicle and could result in an accident or personal injury.

 <b>CAUTION</b>
Never drive your vehicle on improved roads/highways with the Off-Road ABS function turned on. When you drive your vehicle onto an improved road surface or highway, immediately turn off the Off-Road ABS switch. Failure to do so will cause the ABS system to not function properly in an ABS event under 25 mph (40 km/h) and could result in an accident or personal injury.

The ABS lamp flashes slowly during off-road mode engagement. This is done to alert you of a modification to the ABS control software. At speeds above 25 mph (40 km/h), the ABS controller operates in the normal on-highway mode. At speeds between 10 and 25 mph (16 and 40 km/h), the ABS control software is modified to allow short periods (0.25 seconds) of locked- wheel cycles. At speeds

## OPERATING THE BRAKE SYSTEM

---

below 10 mph (16 km/h), the ABS control software is turned off to allow locked wheels. When the Off-Road ABS function is enabled, the Retarder Disable output is turned off. That is, the engine retarders are left to function without ABS intervention. For additional information, see the Off-Road ABS pamphlet in your vehicle's glove box.

### Effectiveness and Limitations

ESC is designed and optimized for trucks and for tractors that tow single trailers. If a tractor equipped with ESC is used to power multiple trailer combinations (known as "doubles" or "triples") the effectiveness of the ESC may be greatly reduced.



#### WARNING!

Exercise extreme care when towing doubles or triples with a vehicle equipped with Electronic Stability Program. Excessive speed and aggressive maneuvers, such as sharp turns, sudden steering inputs or abrupt lane changes should be avoided because these maneuvers could cause loss of vehicle control possibly resulting in an accident involving death or personal injury.

Additionally, the ESC system's effectiveness may be greatly reduced if:

- The load shifts due to improper retention, accident damage or the inherently mobile nature of some loads (for example, hanging meat, live animals or partially laden tankers).
- The vehicle has an unusually high or off-set center of gravity (CG).
- One side of the vehicle drops off the pavement at an angle that is too large to be counteracted by a reduction in speed.
- The vehicle is used to haul double or triple trailer combinations.
- If very rapidly winding steering inputs are inputted at high speeds.
- There are mechanical problems with suspension leveling of the

tractor or trailer resulting in uneven loads.

- The vehicle is maneuvering on a high banked road creating either additional side forces due to the weight (mass) of the vehicle or a deviation between expected and actual yaw rates.
- Gusty winds are strong enough to cause significant side forces on the vehicle and any towed vehicles.

To maximize the effectiveness of ESC:

- Loads must be properly secured and evenly distributed at all times.
- Drivers need to exercise extreme caution at all times, and avoid sharp turns, sudden steering inputs or abrupt lane changes at high speeds, particularly if:
  - The vehicle hauls loads that could shift,

- The vehicle or load has a high or off-set center of gravity (CG) when loaded, or
- The vehicle tows doubles or triples.

The ESC system was specifically calibrated and validated only for your vehicle's original factory-built configuration. If your vehicle's chassis components are altered (for example; a wheelbase extension or reduction, tag axle addition or removal, tractor to truck conversion or steering system component change) the ESC system must be disabled immediately by a qualified mechanic.



### WARNING!

Failure to disable ESC when modifying a vehicle could result in a loss of vehicle control possibly resulting in an accident involving death or personal injury.



### WARNING!

For vehicles equipped with ESC do not replace the vehicle's steering wheel with an aftermarket or different part number than originally supplied. Using a different steering wheel could cause ESC to malfunction causing a loss of vehicle control possibly resulting in an accident involving death or personal injury.

Whenever maintenance or repair work is performed to the steering mechanism, linkage, gear, adjustment of the wheel track, or if the steering angle sensor is replaced or the steering wheel is changed or re-centered, the Steering Angle Sensor must be re-calibrated.



### WARNING!

If the Steering Angle Sensor is not recalibrated, the Yaw Control system will not function properly. A uncalibrated sensor could result in a loss of control of your vehicle which can lead to an accident involving death or personal injury.

### Trailer Brake Hand Valve

This hand valve provides air pressure to apply the trailer brakes only. It operates independently of the foot treadle valve.

#### To operate the trailer brake hand valve:

- Pull down on the lever under the right side of the steering wheel. See Steering Column And Mirrors on page 3-103.
- The valve is self-returning. When pressure is removed from the valve lever, it will return to the OFF position.



### NOTE

The trailer brake is not to be used as a substitute for the service brakes. Using this brake frequently, instead of using the foot brake, will cause the trailer brakes to wear out sooner.



### WARNING!

Do not use the trailer hand brake or service brakes to park and hold an unattended vehicle, use the parking brakes. Because service brakes work with air pressure, these brakes could slowly release. Your vehicle could roll, causing a serious accident. Never rely on the service brakes to hold a parked vehicle. Failure to comply may result in personal injury, death, equipment or property damage.





### Driving With an Unloaded Trailer

Do not use the engine retarder (such as an exhaust brake) to slow the vehicle down when you are pulling an empty trailer.

 <b>WARNING!</b>
Do not use an engine retarder when you are driving with an unloaded trailer. Using engine retarders with an unloaded trailer can cause a wheel lockup resulting in less control and/or jackknife. When you are unloaded, you can have a serious accident if your wheels lock suddenly during braking. Failure to comply may result in personal injury, death, equipment or property damage.

### Engine Retarders

 <b>WARNING!</b>
The engine retarder is <b>NOT</b> intended as the primary brake for the vehicle, nor is it an emergency brake. The engine retarder only helps the service brakes by using pressure to slow the drivetrain. Use the service brakes for quick stops. <b>DO NOT</b> rely only on the engine retarder. Failure to comply may result in personal injury, death, equipment or property damage.

 <b>WARNING!</b>
Do not operate the engine retarder when driving/operating your vehicle on road surfaces with poor traction (wet, icy, or snow covered roads) or in heavy traffic. Braking caused by the normal operation of the engine retarder could cause you to lose control of the vehicle resulting in an accident. Failure to comply may result in personal injury, death, equipment or property damage.

 <b>NOTE</b>
The exhaust brake and engine brake are two types of engine retarders. See your Engine Operation and Maintenance Manual and Engine Retarder or Engine Brake Operation Manual for further details on using these types of engine retarders.

A variety of engine retarders or exhaust brakes may be installed (as

## OPERATING THE BRAKE SYSTEM

4

an option) to create a braking effect on the drive wheels. These devices use your engine's power to slow your vehicle down. Because they can help keep your vehicle's brakes from overheating, they save wear and tear on the service brakes. However, the retarder is not an emergency brake.

Ideally (on normal road surfaces), you should slow your vehicle with the retarder (where permitted by law) and use the service brakes only for stopping completely. Operating this way will greatly prolong the life of the brakes.

### Exhaust Brake

With the exhaust brake switch ON, the brake automatically creates its braking effect when you remove your foot from the accelerator pedal.

The brake switch is located on the accessory dash panel. It controls whether the brake is ON (ready to slow the vehicle down) or OFF (no braking action).

- Do not use the engine retarder (such as an exhaust brake) to slow the vehicle down when you are pulling an empty trailer. See Engine Brakes for further details.



#### WARNING!

Do not use an engine retarder when you are driving with an unloaded trailer. Using engine retarders with an unloaded trailer can cause a wheel lockup resulting in less control and/or jackknife. When you are unloaded, you can have a serious accident if your wheels lock suddenly during braking. Failure to comply may result in personal injury, death, equipment or property damage.

- Make sure the brake is OFF before starting the engine.
- After the engine is started, warmed up, and you are ready to get under way, turn the exhaust brake switch ON for added braking effect.

	<b>WARNING!</b>
<p>Do not use the engine retarder when operating on road surfaces with poor traction (such as wet, icy, or snow covered roads or gravel). Retarders can cause the wheels to skid on a slippery surface. You could lose control of the vehicle and/or jack-knife if the wheels begin to skid, resulting in an accident. Failure to comply may result in personal injury, death, equipment or property damage.</p>	

If your vehicle is equipped with ABS, the operation of the exhaust brake (if turned ON) will be controlled by the ABS. For further details on how to use the exhaust brake, see the exhaust brake manufacturers Owner's Manual.

## Engine Brakes



On/Off Switch Symbol

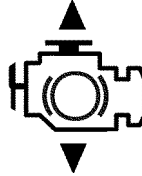

Retardation Level Switch Symbol

There are two switches that control your vehicle's engine brake. One switch turns the system On/Off and the second switch controls the retardation level. These are located in the right-hand switch panel. With the engine brake switch ON, the brake automatically creates its braking effect when you remove your foot from the accelerator pedal.

Depending on the engine, your vehicle may be equipped with either a 2-position or 3-position Retardation Level Switch. If your vehicle has the two-speed system, you can select FULL or HALF. If it has the three-speed system, you can select LOW (1), MEDIUM (2), or HIGH (3) retarding.

See your Engine Operation and Maintenance Manual or Engine Brake Operation Manual for further details on using engine retarders.

# OPERATING THE BRAKE SYSTEM

---

## Brake Components

The following is a brief description of the air/brake system. It is intended to supply you with general information on how the system works.

**Compressor:** supplies air to the system. System pressure is controlled by the governor.

**Governor:** controls the air pressure in the system by actuating the compressor discharge mechanism. Its cut-out pressure is 115 to 125 psi (793 to 862 kPa). Its preset cut-in pressure is set to between 13 to 25 psi (90 to 172 kPa) below the cut-out pressure setting (cut-out and cut-in interval is not adjustable).

**Safety Valve:** installed on the supply air tank outlet. It should vent off at 150 psi (1034 kPa) permitting air to escape.

**Air Dryer:** collects and removes moisture and contaminants from the air as it travels from the compressor to the wet tank.

**Compressed Air Tanks:** The wet tank receives air from the air dryer and cools it somewhat, allowing moisture to condense for draining. Relatively dry air is then supplied to the two service air tanks for distribution to their respective brake circuits. The service air tanks are isolated from each other by check valves.

**Dual Service Brake Treadle Valve:** delivers air to the two service brake circuits.

**Double Check Valve:** directs the higher air pressure from either the rear (primary) or front (secondary) service air tank to the modulating valve.

**Modulating Valve (SR-1):** used only on full trucks, not tractors, performs four functions:

- Limits spring brake hold-off air pressure delivered to the spring brake chambers.
- Provides a quick release of air pressure from the spring brake chambers to speed spring brake application.
- Modulates spring brake application in proportion to front service application in the event of a rear service failure.
- Prevents compounding of service and spring applications.

**Quick-Release Valve:** speeds the release of air from the brake chambers. When air is released, the air in the brake chambers is exhausted at the quick-release valve, rather than

exhausting back through the treadle valve.

**Single Check Valve:** allows air flow in one direction only.

**Parking Brake Valve:** Yellow diamond-shaped knob. It controls the application and release of the parking (spring) brakes of the vehicle or of the vehicle-trailer combinations. If the air system is being charged from zero pressure, the parking brake valve will not hold in the release position until the system pressure exceeds 60 psi (414 kPa), which is the pressure required to override the load of this valve's plunger return spring.

**Trailer Supply Valve:** The Red octagonal-shaped knob protects the vehicle system; it functions in conjunction with the parking brake valve (yellow). The trailer supply valve is responsible for synchronizing the vehicle and trailer parking and

emergency brakes. If the air system is being charged from zero pressure, the trailer supply valve will not hold in the applied position until the system pressure exceeds 50 psi (345 kPa). It automatically pops out and exhausts air if supply air pressure drops below 60 psi (414 kPa).

**Vehicle Protection Valve:** The functions of this valve are to (1) receive all pneumatic signals pertinent to the operation of the trailer brake system, (2) transmit these signals to the trailer, and (3) protect the vehicle air supply in case of separation of the air lines connecting the vehicle to the trailer.

# OPERATING THE ENGINE

## Introduction

For detailed information on starting and operating the engine, refer to the Engine Operation and Maintenance Manual provided with your Kenworth.

Because each vehicle is custom-equipped, all engine operation instructions presented in this section are general. You will want to consult the engine manual to find out details about your vehicle's specific engine needs. You may need to use a slightly different procedure from the one outlined here.

Also, read the American Trucking Association's (ATA) Truck Driver's Handbook. It will give you tips on starting, shifting, and driving your vehicle.

This section includes instructions for both Normal Temperature starting and Cold Weather starting. The engine type (brand) and size determines what type of cold weather starting aid is installed in your vehicle. Refer to your Engine Operation and Maintenance Manual to learn what precautions you should take before starting the engine. Many new electronic engines cannot use ether or other starting fluids. These engines are equipped with a flame-start air intake heating system. See Starting Procedure - Cold Weather on page 4-46.



### WARNING!

Do not use ether or starting fluid in conjunction with flame-start air intake heating systems. Flame-start systems use an open flame inside the manifold to heat the air/fuel mixture for cold weather starting. If ether is also used with flame-start, the air/fuel will ignite inside the manifold, which could cause an explosion. Failure to comply may result in personal injury, death, equipment or property damage.



## WARNING!

Do not start or let the engine run in an enclosed, unventilated area. Exhaust fumes from the engine contain carbon monoxide, a colorless and odorless gas. Carbon monoxide can be fatal if inhaled. Failure to comply may result in personal injury or death.



## CAUTION

Do not park or operate the vehicle in areas where the hot exhaust system may come in contact with dry grass, brush, spilled fuel or other material that can cause a fire.

## Starting Procedure - Normal Temperature

When the outside temperature is above 50° F (10° C), you can use the following procedure:

1. Set the parking brake.
2. Put your main transmission in Neutral.
3. Disengage (depress) the clutch (with manual transmission).
4. Turn the key switch to ON.



## CAUTION

Never operate the starter motor while the engine is running. The starter and flywheel gears could clash or jam, severely damaging them.



## NOTE

Some starters are equipped with overcrank protection. Check the "Engine Operation and Maintenance Manual" for details.

5. Turn the ignition key to the START position. If the engine does not start within 30 seconds, release the ignition switch. To avoid overtaxing the starter motor or the batteries, don't use the starter for more than 30 seconds. Let the starter motor cool and the batteries recover for two minutes before trying again. If the engine still won't start after a couple of tries, check the fuel lines for possible fuel starvation or air leaks. Starting failure may mean fuel isn't reaching the injectors.
6. As soon as the engine starts, begin to watch the oil pressure gauge. Check your engine manufacturer's

## OPERATING THE ENGINE

4

manual for the right pressure for your engine. If the oil pressure doesn't rise within a few seconds, stop the engine. Find out what is wrong before restarting the engine.

7. Slowly engage (release) the clutch after the engine has started.
8. Wait for the oil pressure gauge to reach normal operating pressure before operating the vehicle or idling faster than 1000 rpm.

### Starting Procedure - Cold Weather

In cold weather, fast engine starting helps relieve the loads on the electrical system and cranking motor. Using the special cold starting equipment will help starting. If you follow a few simple guidelines, you will extend the service life of your engine:

- Keep the electrical system in top condition.
- Use the best quality fuel of the recommended grade.
- Use recommended engine lubricating oil.
- For manual transmissions and auxiliary transmissions, leave the transmission in neutral and allow the transmission lubricating oil to warm up (approximately 3-5 minutes) before operating vehicle.

### Engine Block and Oil Pan Heater (Option)

To preheat the engine before starting, plug the optional engine block heater into a properly grounded AC electrical source. Do not start the engine with the heater plugged in.



#### WARNING!

Engine block and oil pan heaters can cause fires which may result in death, injury and/or property damage if not properly maintained and operated. Regularly inspect the engine block heater wiring and connector for damaged or frayed wires. Do not use the heater if there are any signs of problems. Contact your authorized dealer or the manufacturer of the heater if you are in need of repairs or information.





## CAUTION

Always unplug heater before starting the engine. Damage to the cooling system could occur if the heater is not turned OFF (unplugged).

Depending on engine make, when the temperature falls below -10° F (-24° C), the block heater is recommended.

- Use a solution of half ethylene glycol antifreeze and half water for best heater performance. Do not exceed 65 percent concentration of antifreeze, as a shortened heater life will result. See Engine Cooling System on page 5-65, for more information.
- After servicing the cooling system, operate the vehicle for a day or two before using the heater. Trapped air inside the engine needs time to escape.

## Engine Warm-up Engine

The purpose of engine warm-up is to allow oil film to be established between pistons and liners, shafts and bearings while your engine gradually reaches operating temperature.

### Warm-up Procedure

1. After you've started your engine, idle it at approximately 600 RPM while you check:
  - a. oil pressure
  - b. air pressure
  - c. alternator output
2. After a few minutes of idling at 600 RPM, increase your idle speed to 900 or 1000 RPM. Continue your warm-up. This procedure allows oil to warm and flow freely while pistons, liners, shafts, and bearings expand

slowly and evenly. In extremely cold temperatures, you may have to increase idle speed.



## NOTE

In colder climates where the temperature is often below freezing, the warm-up for turbocharged engines is especially important. Chilled external oil lines leading to the turbocharger will slow the oil flow until the oil warms, reducing oil available for the bearings. Watch the engine oil temperature or pressure gauge for a warming trend before increasing engine idle speed (RPM).

3. Continue the engine warm-up until the coolant temperature reaches at least 130° F (54° C). At this temperature, you can use partial throttle. Wait until the coolant temperature is at least 160° F (71° C) before operating at full throttle.

## OPERATING THE ENGINE

4



### WARNING!

Exhaust fumes from the engine contain carbon monoxide, a colorless and odorless gas. A poorly maintained, damaged, or corroded exhaust system can allow carbon monoxide to enter the cab or sleeper. Failure to properly maintain your vehicle could cause carbon monoxide to enter the cab and cause death or personal injury.



### WARNING!

Never idle your vehicle for prolonged periods of time if you sense that exhaust fumes are entering the cab. Investigate the cause of the fumes and correct it as soon as possible. If the vehicle must be driven under these conditions, drive only with the windows slightly open. Failure to repair the source of the exhaust fumes may lead to death or personal injury.



### CAUTION

The use of a winterfront can result in excessive engine coolant, oil, and charge air (intake) temperatures, which can lead to overheating and possible engine damage. If you must use a winterfront:

- Refer to the "Engine Operation and Maintenance Manual" for operating restrictions and recommendations.
- Use only a winterfront available from your dealer that is compatible with an EPA-compliant engine cooling system. These winterfronts are specifically designed for use with new grill snap patterns.





### NOTE

Keep the engine exhaust system and the vehicle's cab/sleeper ventilation system properly maintained. It is recommended that the vehicle's exhaust system and cab/sleeper be inspected:

- By a competent technician every 15,000 miles,
- Whenever a change is noticed in the sound of the exhaust system,
- Whenever the exhaust system, underbody, cab or sleeper is damaged.

	NOTE
	<ul style="list-style-type: none"><li>• Do not stay in the vehicle with the engine running or idling for more than 10 minutes with the vehicle's Heater and A/C ventilation system in RECIRC or at LOW FAN SPEED. Even with the ventilation system On, running the engine while parked or stopped for prolonged periods of time is not recommended.</li><li>• If other vehicles are parked next to you idling, move your vehicle or do not stay in your vehicle for prolonged periods of time.</li></ul>

	WARNING!
	<p>To reduce the chance of death or personal injury and/or vehicle damage from overheated engines, which can result in a fire, never leave the engine idling without an alert driver present. If the engine should overheat, as indicated by the engine coolant temperature light, immediate action is required to correct the condition. Continued unattended operation of the engine, even for a short time, may result in serious engine damage or a fire.</p>

	CAUTION
	<p>Do not allow your engine to idle, at low rpm's (400–600 rpm), longer than five minutes. Long periods of idling after the engine has reached operating temperatures can decrease engine temperature and cause gummed piston rings, clogged injectors, and possible engine damage from lack of lubrication. The normal torsional vibrations generated can also cause transmission wear.</p>

## Idling the Engine

Under most circumstances, idling your engine for long periods merely wastes fuel. In severe arctic weather conditions, however, you may need longer idling to be sure all parts of your engine are fully lubricated.

# OPERATING THE ENGINE

## Transmission

In cold weather [below 32° F (0° C)], you may find shifting sluggish when you first start up. Transmission warm-up is especially important at this time, but it is always a good idea to warm-up your transmission before starting out on the road. To warm-up the transmission, follow these procedures.

4

To warm-up the transmission lubricating oil during engine warm-up, with a single transmission (manual and automatic):

1. Put the transmission in Neutral.
2. Release the clutch pedal (manual only) and operate the transmission in neutral for 3 to 5 minutes prior to operating the transmission in either forward or reverse range.
3. If you have a two-transmission combination:

- a. Put the main transmission in gear.
- b. Put the auxiliary transmission in Neutral. This will allow the transmission countershaft to turn, agitating the oil and warming it.

## Ether Metering Equipment



### WARNING!

Ether starting fluid is flammable and poisonous. Do not smoke near ether or ether equipment, do not ingest ether fluid and wear safety goggles when handling ether fluid. Follow all safety literature provided with your ether equipment. Failure to take these precautions may result in death, personal injury.



### WARNING!

Do not move or relocate the ether cylinder or tubing from its original installation. It must be mounted to protect it from engine exhaust heat and from moving parts which could damage it. Failure to comply may result in death, personal injury, equipment or property damage.



## WARNING!

Do not store the spare cylinder in the cab. Failure to comply may result in death, personal injury, equipment or property damage.

Do not smoke when testing, installing, or servicing an ether starting unit. Service it in a well-ventilated area away from heat, open flames, or sparks.

If swallowed, do not induce vomiting. Call a physician immediately.

Wear goggles to avoid getting fluid in your eyes. Avoid getting it on your skin and avoid breathing the fumes. If fluid does get in your eyes or fumes irritate your eyes, flush for 15 minutes with large amounts of clean water. Contact an eye specialist.

In warm weather, when you will not need the ether starting system, remove the ether bottle from your truck and

store it safely. Return the protective cap to the bottle mounting connector.

For more helpful starting information, refer to the engine manual that came with your vehicle.

Ether injected into the engine cylinder during cold weather startup will help the engine start faster. Using ether during cold weather startup will result in reduced demands on the batteries and the starter motor.

When you turn the ignition switch to the START position, the cranking motor and the ether system are engaged. When needed, starting fluid is released from a pressurized cylinder, flows through a valve and tubing, and sprays from a nozzle in you engine's air intake system.

## Idling the Engine

Under most circumstances, idling your engine for long periods merely wastes fuel. In severe Arctic weather conditions, however, you may need longer idling to be sure all parts of your engine are fully lubricated.



## WARNING!

To reduce the chance of death, personal injury, and/or vehicle damage from overheated engines, which can result in a fire, never leave the engine idling without an alert driver present. If the engine should overheat, as indicated by the engine coolant temperature light, immediate action is required to correct the condition. Continued unattended operation of the engine, even for a short time, may result in serious engine damage or a fire.

## OPERATING THE ENGINE

4



### CAUTION

Do not allow your engine to idle, at low RPM's (400-600 rpm), longer than five minutes. Long periods of idling after the engine has reached operating temperatures can decrease engine temperature and cause gummed piston rings, clogged injectors, and possible engine damage from lack of lubrication. The normal torsional vibrations generated can also cause transmission wear.

During the time it takes you to drink a cup of coffee, your engine can cool as much as 60° F (33° C) below normal operating temperature. To keep the engine warm during a short break, turn it off. Do not allow your engine to idle longer than five minutes.

## Cruise Control

If your vehicle is equipped with cruise control dash switches, follow the operating instructions below.



### WARNING!

Do not operate the cruise control when driving on road surfaces with poor traction (wet, icy, or snow covered roads) or in heavy traffic. Accelerations caused by the normal operation of the cruise control could cause you to lose control of the vehicle resulting in an injury accident.

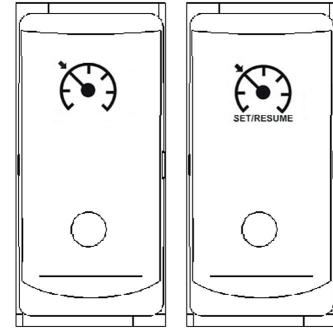

On/Off Switch, Set/Resume Switch

## Using Cruise Control While Driving:

### Setting Cruise Speed

1. Ensure that the vehicle speed is above the minimum cruise control speed and the engine speed is above 1100 rpm.
2. Move the ON/OFF switch to the "ON" position.
3. Accelerate the vehicle to the desired cruise speed.
4. Toggle the SET/RESUME switch to the "SET" position to set the cruise speed.

	<b>NOTE</b>
Cruise Control may not hold the set speed going down hills. If the speed increases going down a hill, use the brakes to slow down. This will cancel Cruise Control.	

### Changing the Cruise Set Speed

- To increase the cruise set speed; Hold the SET/ RESUME switch in the "SET" position until the desired speed is achieved then release the switch.
- To decrease the cruise set speed; Hold the SET/ RESUME switch in the "RESUME" position and coast to the desired lower speed then release the switch.

### Cancelling Cruise Control

You can cancel cruise control in any of these ways:

- Tap the brake pedal.
- Tap the clutch pedal.
- Move the ON/OFF switch to the "OFF" position.

### Resuming Cruise Control

1. If you tapped the brake or clutch pedal, the cruise/idle control remembered the previously set cruise speed. To resume that set speed, accelerate above the minimum cruise control speed and; Toggle the SET/RESUME switch to the "RESUME" position.
2. If you moved the ON/OFF switch to the "OFF" position or turned the ignition key OFF, this cleared the system memory and you will need to set a new cruise speed.

# OPERATING THE ENGINE

## Using Cruise Control for Stationary PTO Operation:

### Setting Idle Speed

1. Ensure parking brakes are applied.
2. Ensure transmission is in Neutral.
3. Engage PTO per the manufacturer's operating instructions.
4. Move the ON/OFF switch to the "ON" position.
5. Toggle the SET/RESUME switch to obtain the desired engine rpm.

### Canceling Cruise Control

You can cancel cruise control in any of these ways:

- Tap the brake pedal.
- Tap the clutch pedal.
- Move the ON/OFF switch to the "OFF" position.

## Engine Fan Control



The engine fan can be turned ON using a switch that is mounted on the accessory switch panel. This lets you set the fan to manual or automatic operation.

- With the ignition key turned ON and the fan switch in the MANUAL position, the engine fan will be ON regardless of engine temperature.
- With the engine fan switch in the AUTO position, the engine fan will automatically turn ON when any one of the following conditions occur: 1) the engine coolant temperature reaches 200° F (93° C) approximately, 2) the Air Conditioning system is turned ON or has reached a set pressure

point, or 3) the Engine Control Unit detects that air intake temperature, oil temperature, or compression brake usage requires it.



### WARNING!

Do not work on or near the fan with the engine running. Anyone near the engine fan when it turns on could be injured. If it is set at MANUAL, the fan will turn on any time the ignition key switch is turned to the ON position. In AUTO, it could engage suddenly without warning. Before turning on the ignition or switching from AUTO to MANUAL, be sure no workers are near the fan.



### CAUTION

The fan or equipment near it could be damaged if the fan turns on suddenly when you do not expect it. Keep all tools and equipment away from the fan.



	<b>NOTE</b>
<p>Do not operate the engine fan in the MANUAL position for extended periods of time. The fan hub was designed for intermittent operation. Sustained operation will shorten the fan hub's service life as well as reduce fuel economy.</p>	

## Engine Control Display

Your Kenworth may come with an optional Engine and Driver Information Display. This instrument records information on engine diagnostics, scheduled maintenance, driving conditions, and general trip information. The specific features of your display may vary depending on engine make. For complete information on the display see the engine manufacturer's manual.

## Engine Shutdown System

This system is an option with each engine. The engine shutdown system continually monitors oil pressure and engine temperature. If either condition changes beyond the normal range of oil pressure or temperature readings, the engine shuts down automatically, sounding the alarm and turning a warning light on. The buzzer will sound continuously as long as Stop Engine indicator is on.

After the engine starts, and until oil pressure reaches normal operating pressures, a warning alarm will sound. As soon as oil pressure increases, the buzzer turns off automatically. If the engine shuts down automatically or if the buzzer and light turn on while the engine is running, have your engine serviced at an authorized Kenworth Dealer.

## OPERATING THE ENGINE

---

Each shutdown system is engine specific; therefore to learn how this system works on your vehicle, you should consult the engine manufacturer's manual.

## OPERATING THE REAR/DRIVE AXLE

### Introduction

This section covers the operation of your Rear/Drive Axle. These instructions apply to the most common features of drive axles. Refer to the manufacturers instructions for further information on the operation of your axle.

### Inter-Axle Differential Lock



The inter-axle differential allows each axle to turn independently, which relieves stress on the rear axles and reduces tire wear. A switch on the accessory switch panel locks the inter-axle differentials, which gives you better traction for slippery surfaces. You will notice that the switch has a guard to protect you from activating it accidentally.

### When to Use the Differential Lock

In the LOCK position, an air operated clutch positively locks both sets of axles together, providing greater traction on slippery road surfaces; however, steering around corners and on dry pavement is more difficult. Continuous operation on a paved, dry surface stresses the tandem axles, possibly causing internal damage.

Only use this feature when driving on surfaces with poor traction, such as heavy mud or snow, or loose gravel. And do not use it when going downhill or at speeds greater than 25 mph (40 km/h).

**Lock the differential when you encounter road conditions such as these:**

- Ice or snow, with or without tire chains.
- Dirt roads.

## OPERATING THE REAR/DRIVE AXLE

- Loose sand, mud, or other off-road conditions.



### WARNING!

Do not put the differential lock in the LOCK position while the wheels are spinning freely (slipping), you could lose control of the vehicle or cause axle damage. Switch to LOCK only when the wheels are not spinning. Failure to comply may result in personal injury, death, equipment or property damage.



### WARNING!

Do not operate the vehicle on dry pavement with the differential locked, this could lead to an accident. On dry pavement, you will not be able to steer well with the differential locked. Lock the differential only when operating on surfaces with poor traction, such as wet, slippery roads or loose gravel. Failure to comply may result in personal injury, death, equipment or property damage.

### Inter-Axle Differential Lock Operation



### WARNING!

Do not use the differential lock during downhill operation or at speeds above 25 mph (40 km/h). When it is engaged under these conditions, your vehicle will exhibit understeer handling characteristics. This understeer condition will cause your vehicle to not turn as quickly and more steering effort will be required, which can cause an accident. Failure to comply may result in personal injury, death, equipment or property damage.

4

- Look ahead for wet, muddy, or icy patches on the road, stop your vehicle and switch to LOCK ahead of time.



## Understeer Condition

- 1 Turning Radius When Unlocked (Disengaged)
- 2 Turning Radius When Locked (Engaged)

### To LOCK the inter-axle differential:

1. Anticipate when you might need increased traction, slow down to a steady speed under 25 mph (40 km/h) or stop the vehicle. Do not lock the differential while going down steep grades or traveling faster than 25 mph (40 km/h), or while wheels are spinning or traction is minimal; lock the differential before you encounter these conditions.

2. Put the inter-axle differential lock switch in the LOCK position. A light on the switch will turn on, indicating that the differential is locked (engaged).
3. If you LOCK or UNLOCK the differential while moving, let up momentarily on the accelerator pedal to relieve torque on the gearing and allow full engagement of the clutch (mechanism that locks the wheels).

<b>i</b>	<b>NOTE</b>
<p>The Meritor main differential lock or Dana Spicer wheel differential lock is controlled by the switch labelled WHEEL DIFFERENTIAL. By moving the switch you can LOCK or UNLOCK the main differential when the vehicle is moving or stopped.</p>	

<b>i</b>	<b>NOTE</b>
<p>If your vehicle has an automatic transmission, it may be necessary to shift the transmission to the Neutral position momentarily to allow the main differential lock splines to fully engage or disengage.</p>	

4. Drive the vehicle through the poor traction area, keeping your speed under 25 mph (40 km/h).

### To UNLOCK the inter-axle differential:

1. When you reach dry pavement or better road conditions where the differential lock is not needed, switch the differential lock to UNLOCK.
2. Let up momentarily on the accelerator pedal to relieve torque and allow the clutch to disengage.

## OPERATING THE REAR/DRIVE AXLE

- When you unlock the differential, normal vehicle handling will resume and the light on the switch will turn off.

### Driver Controlled Main Differential Lock

If your Kenworth has a Meritor axle with a Driver Controlled Main Differential Lock, install the caging bolt before removing the axles for towing. Installation of the caging bolt prevents damage by locking internal axle components in position. Use the procedure below to lock the Meritor differential.

- Remove the air line.
- Remove the caging bolt from its storage hole.
- Screw the caging bolt all the way into the air line hole. This locks the differential by pushing a piston into lock position.

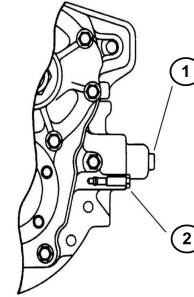

Driver Controlled Main Differential Lock

- Air Line - Remove to Install Caging Bolt
- Caging Bolt Storage Location

## Dual Range (Two-Speed) Rear Axle

Your vehicle may be equipped with a two-speed or dual range axle (option). You can select two rear axle ratios for operating under heavy loads or rough terrain as well as for over the road hauling.

The Low Range provides maximum torque for hauling heavy loads or traveling over rough terrain. The High Range is a faster ratio for highway speeds and general over the road conditions. A switch on the accessory switch panel controls the Dual Range Rear Axle. You will notice that the switch has a guard to protect you from activating it accidentally. Always park your vehicle with the range selector in LOW.

### Dual Range Axle Operation

Important tips on operating a Dual Range Axle with Interaxle Differential:

1. Shift the axle with the inter-axle differential in the unlocked position only.
2. When you are driving with poor traction, lock the differential. When you have the differential locked, drive with the axle in LOW range only.
3. When you are driving on a surface with good traction, keep the interaxle differential unlocked. You can drive with the axle in the LOW or HIGH range.
4. Always UNLOCK the inter-axle differential before shifting the axle speed range.



#### CAUTION

If you shift the axle range with the inter-axle differential in LOCK, you could seriously damage the axles. Never shift the axle range with the differential locked.

## OPERATING THE REAR/DRIVE AXLE

---

### Starting-Up

1. Unlock the inter-axle differential before starting.
2. Put the Range Selector in the LOW range. Shift the transmission to start the vehicle moving.
3. When you are driving on rough terrain and secondary roads, or under a very heavy load, keep the axle in the LOW range. Shift the transmission to maintain proper road speed.



#### WARNING!

Never shift the axle when moving down hill. Engine driveline disengagement may occur, eliminating engine retardation and allowing the wheels to spin faster than the current speed of the engine. This may require severe braking to slow the vehicle down and can result in an accident. Failure to comply may result in personal injury, death, equipment or property damage.

Proper shifting of the axle depends on the synchronization of engine/driveline and wheel speed. When you shift the axle, the connection between the engine and wheels is momentarily disengaged while the gearing is synchronized. Normally when the axle is shifted the speed of the engine, axle, and wheels adjust, allowing for proper gear engagement.

When going down hill the wheels will not slow down, but will tend to speed up, which makes gear synchronization almost impossible. As a result, the axle is neither in HIGH nor LOW range and all engine/driveline retardation is lost. Without engine retardation it is more difficult to slow the vehicle down and greater stress is put on the brake system.



#### CAUTION

To avoid damaging your vehicle shift the axle at slower travel speeds until you are used to driving with a dual range axle.



### LOW to HIGH (Cruising)

When you go from rough terrain to highway driving, shift the axle to the HIGH range following this procedure:

1. Be sure the differential is **UNLOCKED**.
2. Maintain your vehicle speed (accelerator depressed) and move the Range Selector lever to **HIGH**.
3. Keep driving with the accelerator depressed until you want the axle to shift.
4. To make the axle shift, release the accelerator until the axle shifts. You are now in the HIGH axle range for highway speeds. Shift the transmission normally to reach your desired cruising speed.

### HIGH to LOW (Rough Terrain)

If you need to downshift the axle for more power or you are driving on rough terrain:

1. Maintain your vehicle speed (accelerator depressed) and move the Range Selector lever to **LOW**.
2. Keep driving with the accelerator depressed until you want the axle to downshift.
3. To make the axle downshift, release and depress the accelerator quickly to increase the engine RPM. The axle will shift to LOW range.
4. You are now in the LOW axle range for rough terrain and heavy loads. Shift the transmission normally to maintain the desired speed.

### Auxiliary Axles - Pusher or Tag

Adjustable auxiliary axles can add to the productivity of your vehicle. It is important to recognize that when adjustable auxiliary axles are not deployed while the vehicle is carrying a load, excessive loads may be forced onto other vehicle components (frame, axles, suspension, brakes, steering, tires, etc.). This overload condition may reduce the service life of these vehicle components. Acceptable service life is maintained through careful operation, proper maintenance and proper adherence to the vehicles and auxiliary axle manufacturers operating limits.

If your vehicle is equipped with factory-installed pusher or tag axle(s), or you have a third-party (i.e. body-builder) install these axles, it is your responsibility to ensure that the axle lift controls or air-dump valve (if

## OPERATING THE REAR/DRIVE AXLE

equipped) are calibrated prior to putting the vehicle into service. The reason for doing this important calibration is to obtain the proper axle load distribution for the entire vehicles axles. As with the entire vehicles axles, the pusher or tag axle load cannot exceed the certified GAWR and/or the legal load limit of the axle assembly and its related components.

There are three types of pusher or tag axles:

- Lifiable/steerable (axle lift calibration required)
- Lifiable/non-steerable (axle lift calibration required)
- Non-lifiable (some suspensions require dump valve calibration)

### Functionality of Auxiliary Axles installed by Kenworth

- Any lifiable steerable auxiliary axles installed by Kenworth will raise when the parking brake is engaged.
- Any lifiable steerable auxiliary axles installed by Kenworth will raise when the vehicle is placed into reverse.
- Lifiable/non-steerable axles do not raise when parking brake is engaged or if vehicle is in reverse.



### WARNING!

Do not operate or park the vehicle with auxiliary axles in the down/loaded position when vehicle is unladen, or is being unloaded. Raise or dump air into driver-controlled auxiliary axle(s) prior to unloading vehicle. Failure to do so can result in loss of vehicle control or rollaway that may result in personal injury, death, equipment or property damage.

	<b>CAUTION</b>
<p>Never exceed the manufacturers assigned gross axle weight ratings (GAWR) of each axle when the auxiliary axles are downloaded. Never exceed the manufacturers creep ratings when operating with a load when the auxiliary axles are unloaded. Refer to your vehicles compliance decals located on the LH doorjamb for the maximum allowable load for each axle. Exceeding the specified weight rating of any axle can cause equipment damage.</p>	

	<b>NOTE</b>
<p>Axle Creep Ratings are assigned by the axle manufacturer and are based on axle model and intended service of the vehicle. To find out what the allowable creep rating is for your vehicle, contact the nearest authorized Kenworth Dealer or axle representative.</p>	

## Axle Creep Rating Definition Creep Ratings

Low speed, off-highway (work site) axle loads, which exceed the standard gross axle weight rating (GAWR) of a particular axle.

Operator's using vehicles equipped with liftable auxiliary axles must consider creep ratings when any liftable axle is unloaded or in the raised position. Liftable auxiliary axles should only be raised (or unloaded) to improve maneuverability in an off-road use or when vehicle is unloaded.

	<b>NOTE</b>
<p>Axle Creep ratings <b>MUST NOT</b> be exceeded.</p>	

Contact your Kenworth Dealer or axle manufacturer to determine what the creep rating is for your particular axle(s) and configuration. Creep

ratings are generally limited to the following:

- Tandem rear axles only
- Straight trucks only
- Maximum spring mount centers per axle manufacturers specifications
- Maximum tire static loaded radius (SLR) per axle manufacturers specifications

	<b>CAUTION</b>
<p>Always lower the axles as soon as possible after receiving a load. Never exceed 5 miles per hour when driving with a load with the auxiliary axle(s) raised/unloaded. Failure to lower the axle(s) can overload the frame and remaining axles, and could cause equipment damage.</p>	

## OPERATING THE REAR/DRIVE AXLE

4



### WARNING!

Never operate the vehicle with more pressure in the lift axles than is necessary to carry the load, as determined by the calibration procedure described. Failure to do so can result in loss of traction and stability at the steer and/or drive axles and can result in increased braking distance which could cause loss of vehicle control resulting in an accident. Failure to comply may result in personal injury, death, equipment or property damage.



### CAUTION

Do not modify the air system and/or control functionality on a factory installed auxiliary axle(s). Modifying the factory operation of the pusher and/or tag axle(s) will void your warranty, and can cause equipment damage.



### CAUTION

A change in tire size on either the auxiliary axles or the drive/steer axles can change the calibration of the auxiliary axles. If tires are installed with a different loaded radius, the calibration procedure must be repeated. Failure to do so can cause equipment damage.

### Liftable/Steerable or Liftable/Non-Steerable Pusher and/or Tag Axle Calibration Procedure

Below are some general instructions on how to adjust and calibrate the air control valve for the auxiliary axles to obtain the proper load distribution of the axle(s). For additional operating and maintenance instructions, see the pusher or tag suspension manufacturer literature in the glove box or contact them directly.



### NOTE

This procedure must be performed prior to placing the vehicle into service.

## Setting the Pressure-to-Load Ratio

To obtain the desired axle load distribution, you must correlate the suspension air gauge pressure to the actual axle load by scaling the axle weight(s) and adjusting the pressure to obtain the desired load. Once the desired load or load range is achieved, document the pressure-to-load ratio or setting for future use.

## General Calibration Guidelines

These instructions are general in nature. For more specific instructions, review the pusher or tag suspension manufacturers maintenance manual or contact the nearest authorized dealer.

	<b>NOTE</b>
Perform this procedure at or near a weight scale. Procedure can be performed while parked on the weight scale if scale is available.	

1. Park loaded vehicle on level surface with wheels blocked.
2. Release vehicles spring brakes. (Do not release for Lifiable/Non-Steerable pusher or tag axles).
3. Lower the pusher/tag axles with the axle lift control flip valve. (For some non-lifiable axles, inflate air suspension).

4. Adjust the amount of load on each axle by turning the pressure regulator clockwise to increase the load or counterclockwise to decrease the load. (The suspension manufacturer may publish pre-established Pressure-to- Load Ratio Pressure Settings to assist you in achieving an estimated ground load).
5. After setting the pressure to obtain the desired axle load, verify proper ground loading with the weight scale.

	<b>NOTE</b>
Exceeding local, state or federal weight limits may result in citations. Contact your local commercial weight enforcement office for limits in your area.	

# OPERATING THE REAR/DRIVE AXLE

---

## Operation Guidelines

<b>i</b>	NOTE
Steerable-pusher and/or tag axle(s) will raise when the transmission is shifted into reverse or when the parking brakes are applied.	

## Maximizing Drive Axle Traction

Adjust the pressure regulator control knob to a lower pressure until desired traction is obtained. By reducing air pressure at pusher or tag axle, load will be transferred to drive axles. Do not overload drive axles.

## Coupling to a Loaded Trailer

Inflate air springs of the auxiliary axles to the desired pressure after coupling to a loaded trailer while still maintaining proper traction of the drive axles.

### Unloading Operation

Always deflate air springs of the auxiliary axles before attempting to unload vehicle. This allows maximum traction of the drive axles to control the vehicle.

### Non-liftable (Non-steerable) Axles

Some suspensions require dump valve calibration.

Example: Neway dead axles do not lift, but the air can be dumped out of them to unload them when empty. Air pressure is controlled via an adjustable regulator. These axles need to be calibrated for load.

Contact your authorized Kenworth Dealer or axle/suspension manufacturer for dump valve calibration procedures.

# OPERATING THE TRANSMISSION

## Introduction

Your Kenworth is equipped with either a manual or automatic transmission with special features and gearing to meet your particular needs. It is important for you, the driver, to understand how your particular transmission is operated. To do this, you have two sources: this Operator's Manual and the transmission manufacturer's Driver/Operator's Instruction Manual. Because of the wide variety of different transmissions installed in Kenworth vehicles, operating procedures for your particular transmission are not included in this manual; therefore, you should read and understand both manuals. Read the general guidelines and instructions that follow and read the specific instructions contained

in the transmission manufacturer's Driver/Operator's Instruction Manual.

You will find a shift pattern diagram in the cab. Check to be sure you know the correct sequence for your particular transmission.

## Transmission Warm-Up

In cold weather (below 32° F (0° C), you may find shifting sluggish when you first start up. Transmission warm-up is especially important at this time, but it is always a good idea to warm-up your transmission before starting out on the road. To warm-up the transmission, follow these procedures.

To warm-up the transmission lubricating oil during engine warm-up, with a single transmission (manual and automatic):

1. Put the transmission in Neutral.
2. Release the clutch pedal (manual only) and operate the transmission in neutral for 3 to 5 minutes prior to operating the transmission in either forward or reverse range.
3. If you have a two-transmission combination:



- Put the main transmission in gear.
- Put the auxiliary transmission in Neutral. This will allow the transmission countershaft to turn, agitating the oil and warming it.

### Operating Manual Transmissions

The transmission shift pattern for your vehicle may be located on the driver's sun visor and shift control knob. In addition to understanding the shift pattern and its location, you should read the transmission manufacturer's manual provided with your vehicle before operating the vehicle.

### Putting the Vehicle in Motion

After making sure the vehicle's oil and air pressure are correct and all other parts and systems are in proper working condition:

1. Fully depress the clutch pedal (for manual transmission) until the clutch brake makes contact. The contact will occur at about 1 inch (2.54 cm) or less from the floorboard.
  - The total stroke of the clutch pedal is about 10 inches (25.4 cm). The first 1-½ inches (3.81 cm) is free travel. After the free travel comes the release stroke, which is the part that fully releases the clutch. The last 1 inch (2.54 cm) engages the clutch brake.
  - Always start out in a low gear. Starting in higher gears, even with a light load, will

## OPERATING THE TRANSMISSION

---

cause a very jumpy start and excessive wear.



### CAUTION

Always use first gear or a low speed range to start the vehicle in motion. The use of a higher gear or speed range forces undue strain on the engine, clutch, other transmission components, and may cause damage.

4

2. Evaluate the road surface conditions and terrain your vehicle is on. Select a gear low enough to let your vehicle start forward with the throttle at idle.
3. Push the parking brake valve handle (Yellow) against the dash panel to release the brakes.
4. Release the clutch pedal (manual only), then gradually accelerate to permit smooth starting,

5. Do not allow your vehicle to roll (even a little) in the opposite direction during clutch engagement. If you need to start up on an incline, apply your service brakes before you release the parking brake. Then release your service brakes as you engage the clutch and apply throttle.

For further instructions on operating your transmission, see the transmission manufacturer's Driver/Operator's Instruction Manual.

If you have a misaligned gear condition in your vehicle's transmission and cannot start, gradually release the clutch, allowing the drive gear teeth to line up properly. Then the drive gear can roll enough to allow the teeth to line up properly and complete the shift.

The best engine performance and maximum economy is obtained if gears are properly selected. This efficiency is achieved by always selecting gears within optimum engine RPM, which is where maximum torque and power are obtained. For further information, see More Driving Tips and Techniques on page 4-5.

## Shifting Gears in a New Vehicle

Shift carefully in a new vehicle. The transmission may be a little stiff at first. Avoid gear clashing, by closely following these procedures.

When you are operating a new vehicle or one that has been exposed to cold weather, you want the transmission lubricant (fluid) to circulate and coat the contacting surfaces of the gears. Metal contacting metal in moving parts may seriously damage your transmission, do not drive in one gear for long periods of time until the transmission lubricant has a chance to coat all contacting surfaces. Carefully observe the free travel in the clutch for the first few hundred miles. As the clutch lining wears and high spots get worn smooth, you will get less free travel.

## Clutch Brake and Travel

The clutch brake is used for stopping transmission gears, allowing you to easily shift into first gear or reverse without grinding gears. Approximately the last one inch of clutch pedal travel activates the clutch brake.

- To apply the clutch brake (while the vehicle is stopped) fully depress the clutch pedal to the floorboard to stop the gears. With the throttle at idle, select first gear then release the clutch pedal to let the vehicle start forward, until the clutch is fully engaged. See the manufacturer's Driver/Operator's Instruction Manual for further details.

If the transmission has a butt-tooth condition and you cannot engage a gear, gradually release the clutch. Then the drive gear can roll enough to allow the teeth to line up properly and complete the shift.

## During Normal Driving

If you want to shift directly into any gear other than first or reverse, depress the clutch pedal only far enough to release the clutch. Pushing the clutch to the floor applies the clutch brake and could cause gear hang-up.



### CAUTION

Be careful not to apply the clutch brake while the vehicle is moving. The purpose of the clutch brake is to stop the transmission so that you can shift into a starting gear without grinding gears. Applying the clutch brake when the vehicle is moving causes a braking effect on the drivetrain and shortens the service life of the clutch brake.

# OPERATING THE TRANSMISSION

---

## Double Clutching

Whether you are upshifting or downshifting, it is best to double clutch.

Double clutching is easier on the transmission and on the engine, helping your vehicle match engine speed with driveline speed and achieving clash-free shifts.

### To double clutch:

1. Push the clutch pedal down to disengage the clutch.
2. Move the gear shift lever to neutral.
3. Release the pedal to engage the clutch. This lets you control the RPM of the mainshaft gears, allowing you to match the RPM of the mainshaft gears to those of the output shaft.

- Upshifts: let the engine and gears slow down to the RPM required for the next gear.
  - Downshifts: press accelerator, increase engine and gear speed to the RPM required in the lower gear.
4. Now quickly press the pedal to disengage the clutch and move the gear shift lever to the next gear speed position.
  5. Release the pedal to engage the clutch.

## More Transmission Tips

### Riding the Clutch

The clutch is not a footrest. Do not drive with your foot resting on the clutch pedal. It will allow your clutch to slip, causing excessive heat and wear, damage could result.

### Release Bearing Wear

When you must idle your engine for any period of time, shift your transmission to neutral and disengage the clutch (take your foot OFF of the pedal). This helps prevent unnecessary wear to your clutch release bearing, and it is less tiring for you, too.

### Clutch Adjustment

Inspect manual clutches according to the manufacturer's recommendations. Regular maintenance should be followed to maintain correct clutch adjustment. Have your dealer's Service Department perform any adjustment necessary.

### Tips

- Always use the clutch when making upshifts or downshifts.
- Always select a starting gear that will provide sufficient gear reduction for the load and terrain.
- Never downshift when the vehicle is moving too fast.
- Never slam or jerk the shift lever to complete gear engagement.
- Never coast with the transmission in neutral and the clutch disengaged.

- To provide smooth gear engagements while shifting, use proper coordination between shift lever and clutch.

# OPERATING THE TRANSMISSION

## Transmission Oil Temperature Gauge

The Transmission Temperature Gauge (option), see Transmission Oil Temperature Gauge on page 3-66, indicates the temperature of the oil in the transmission. Watch this gauge to know when the transmission is overheating: if it is, have it checked by an authorized service representative.

## Operating Automatic Transmissions

An automatic transmission makes shifting much easier, of course. But because your truck pulls a heavy load, it is important to use it efficiently. For correct automatic transmission operation, see the manufacturer's Driver/Operator's Instruction Manual.

- On most automatic transmissions there is no PARK position, so you will need to apply the parking brake before leaving the cab. See Using the Parking Brake on page 4-20.

 <b>WARNING!</b>
If your vehicle has a Freedomline transmission, be aware that it can roll backwards when stopped on a hill or grade, or when starting from a stop on a hill or grade. Failure to comply may result in personal injury, death, equipment or property damage. Observe the following guidelines:

 <b>WARNING!</b>
Do not leave the cab without applying the parking brake. The truck could roll and cause an accident. Always apply the parking brake before you leave the cab. Failure to comply may result in personal injury, death, equipment or property damage.

## Auxiliary Transmissions

If you have an auxiliary transmission installed on your Kenworth, see the transmission manufacturer's Driver/Operator's Instruction Manual to learn how to operate it correctly.

## Steerable Drive Axle

	<b>CAUTION</b>
The customer cannot change axle ratios or tires without Kenworth Engineering approval.	

If you have a Steerable Drive Axle installed on your Kenworth, refer to the auxiliary transmission/transfer case manufacturer's Driver/Operator's Instruction Manual to learn how to operate correctly.

# SHUT-DOWN

## Introduction

After you have parked in a safe place check your vehicle to make sure it will be ready for the next trip. To make sure your vehicle is ready to go after a long stop (such as overnight), please follow the suggestions below. Your vehicle will be easier to get going when you are ready, and it will be safer for everyone who might be around it.

4

Please remember, too, that in some states it is illegal to leave the engine running and the vehicle unattended.

## Final Stopping Procedures

1. Set the parking brake before leaving the driver's seat.  
**To hold your vehicle while it is parked, DO NOT rely on the following:**
  - air brakes
  - hand control valve for trailer brakes
  - engine compression**Always use your parking brakes!**

 <b>WARNING!</b>
Do not use the trailer hand brake or service brakes to park and hold an unattended vehicle, use the parking brakes. Because service brakes work with air pressure, these brakes could slowly release. Your vehicle could roll, causing a serious accident. Always set the parking brakes. Never rely on the service brakes to hold a parked vehicle. Failure to comply may result in personal injury, death, equipment or property damage.

2. If you must park on a steep grade, always block the wheels.
3. Drain water from the air tanks.
4. While the engine and air supply system are still warm, drain moisture from the air tanks. Open the tank drains just enough to drain the moisture. Do not deplete the entire air supply.



5. Secure the vehicle, close all the windows, and lock all doors.

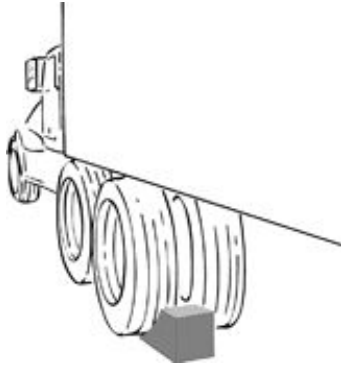

Blocked Wheels

## Before Stopping the Engine

Do not shut off the engine immediately. A hot engine stores a great amount of heat and it does not cool down immediately after you shut it off. Always cool the engine down before shutting it off. You will greatly increase its service life.

Idle the engine at 1,000 rpm for five minutes. Then low idle for thirty seconds before shutdown. This will allow circulating coolant and lubricating oil to carry away heat from the cylinder head, valves, pistons, cylinder liners, turbocharger, and bearings. This way you can prevent engine damage that may result from uneven cooling.

## Turbocharger

This cooling-down practice is especially important for a turbocharged engine. The turbocharger on your vehicle contains bearings and seals that are subjected to hot exhaust gases. While the engine is operating, heat is carried away by circulating oil. If you stop the engine suddenly after a hard run, the temperature of the turbocharger could rise to as much as 100° F (55° C) above the temperature reached during operation. A sudden rise in temperature like this could cause the bearings to seize or the oil seals to loosen.

# SHUT-DOWN

## Refueling

Air inside the fuel tanks allows water to condense in the tank. To prevent this condensation while the vehicle is parked for extended periods of time, fill the tanks to 95 percent of capacity. Never fill to more than 95 percent capacity as this provides room for expansion resulting from temperature extremes. When refueling, add approximately the same amount to each fuel tank on vehicles with more than one tank.

4



### WARNING!

Do not carry additional fuel containers in your vehicle. Fuel containers, either full or empty, may leak, explode, and cause or feed a fire. Do not carry extra fuel containers, even empty ones are dangerous. Failure to comply may result in personal injury, death, equipment or property damage.



### WARNING!

Do not remove a fuel tank cap near an open flame. Diesel fuel in the presence of an ignition source (such as a cigarette) could cause an explosion. A mixture of gasoline or alcohol with diesel fuel increases this risk of explosion. Use only the fuel and/or additives recommended for your engine. Failure to comply may result in personal injury, death, equipment or property damage.

**Specification:** Use only Ultra Low Sulfur Diesel (ULSD) Fuel, as recommended by engine manufacturers. If you need further information on fuel specifications, consult the Engine Operation and Maintenance Manual.

## Location of Fuel Shut-Off Valves

If your vehicle is equipped with shut-off valves for the take-off and return lines, they are located on the fuel lines entering the top of the fuel tank. Fuel shut-off valves for the fuel crossover line are on the bottom of the fuel tank, at the crossover line connection.

**PREVENTIVE MAINTENANCE**

Introduction . . . . . 5-7  
Safety Precautions . . . . . 5-7  
Environmental Protection and Material Hazards. . . . . 5-8

**MAINTENANCE SCHEDULE AND LUBRICATION**

Introduction . . . . . 5-10  
Preventive Maintenance Intervals and Schedule . . . . . 5-10  
Lubrication Specifications . . . . . 5-33  
Oil Reservoirs . . . . . 5-34  
Lubrication Chart . . . . . 5-35

**AIR SYSTEM MAINTENANCE**

Introduction . . . . . 5-38  
Scheduled Maintenance . . . . . 5-39  
Air Tanks . . . . . 5-41  
Air Gauges and Air Leaks . . . . . 5-41  
Air Compressor. . . . . 5-43  
Air Dryer. . . . . 5-44

Air Intake System . . . . .	5-46
Turbocharger . . . . .	5-47
Air Cleaners and Filter Replacement . . . . .	5-48

## **BRAKE SYSTEM MAINTENANCE**

Introduction . . . . .	5-49
Checks and Adjustments. . . . .	5-51
Anti-Lock Braking System (ABS) . . . . .	5-54

## **CAB MAINTENANCE**

Exterior Maintenance . . . . .	5-56
Cleaning, Protecting and Weather Stripping . . . . .	5-57
Safety Restraint System - Inspection . . . . .	5-60
Windshield Wiper/Washer . . . . .	5-64

## **COOLING SYSTEM MAINTENANCE**

Topping Up. . . . .	5-65
Adding Coolant . . . . .	5-67
Change and Refilling . . . . .	5-69
Radiator Cap . . . . .	5-70

Engine (Block) Heater . . . . . 5-70

**ELECTRICAL MAINTENANCE**

Electrical System . . . . . 5-71  
Fuses, Circuit Breakers, and Relays . . . . . 5-71  
Fuse Inspection and Replacement . . . . . 5-72  
Adding Electrical Options . . . . . 5-73  
Batteries . . . . . 5-78  
Battery Care . . . . . 5-81  
Battery Charging . . . . . 5-81  
Electrical and Alternator Precautions . . . . . 5-84  
Remote Keyless Entry . . . . . 5-84  
Halogen/HID Lamp Headlamp Servicing . . . . . 5-85

**ENGINE MAINTENANCE**

Engine Maintenance . . . . . 5-90  
Engine Lubrication . . . . . 5-91  
Fuel System . . . . . 5-94  
Accessory Drive Belts . . . . . 5-95  
Engine Fan . . . . . 5-96

Exhaust System . . . . . 5-96  
Engine Mounting . . . . . 5-97  
All Models . . . . . 5-97  
Multi-Function Message Display . . . . . 5-98

**FRAME MAINTENANCE**

Introduction . . . . . 5-99

**FRONT AXLE AND SUSPENSION MAINTENANCE**

Axle Lubrication . . . . . 5-103  
Inspection . . . . . 5-104  
Wheel Alignment . . . . . 5-104  
U-Bolt Torque . . . . . 5-104

**HEATER AND AIR CONDITIONER MAINTENANCE**

Introduction . . . . . 5-106  
Heater. . . . . 5-107  
Air Conditioner . . . . . 5-108

**NOISE AND EMISSION CONTROL MAINTENANCE**

Noise Emission Warranty . . . . . 5-109

Inspection and Maintenance Instructions . . . . .	5-111
Noise Control System - Maintenance Log . . . . .	5-116

## **REAR AXLE AND SUSPENSION MAINTENANCE**

General Maintenance . . . . .	5-119
Visual Inspection . . . . .	5-120
Rear Suspension Fasteners . . . . .	5-121
Rear Axle Lubrication . . . . .	5-122
Rear Axle Alignment . . . . .	5-123

## **STEERING AND DRIVELINE MAINTENANCE**

Power Steering . . . . .	5-124
Fluid Level and Refill . . . . .	5-125
Steering Driveline . . . . .	5-126
Driveshaft . . . . .	5-127

## **TIRES AND WHEEL MAINTENANCE**

Introduction . . . . .	5-128
General Safety Requirements . . . . .	5-128
Speed Restricted Tires . . . . .	5-129

Tire Inspection and Replacement . . . . . 5-130  
Tire Inflation and Loading . . . . . 5-130  
Wheel Mounting and Fastening . . . . . 5-133  
Wheel Bearing Adjustment . . . . . 5-135  
Wheel Replacement with Disc Brake Option . . . 5-136  
Disc Wheels . . . . . 5-137  
Comparing Hub Piloted and Ball Seat Parts . . . 5-137  
Tire Replacement . . . . . 5-138

**TRANSMISSION MAINTENANCE**

Introduction . . . . . 5-141

**CLUTCH**

Introduction . . . . . 5-142  
Clutch Linkage . . . . . 5-142  
Clutch Adjustment - Normal Wear . . . . . 5-143



# PREVENTIVE MAINTENANCE

## Introduction

This section will help you keep your Kenworth in good running condition. There are a number of checks you can do, and you may be able to do some of the service work yourself. But please, let your Kenworth Dealer do any work you do not have the tools or skill to perform. Authorized service mechanics are trained in the proper technical and safety procedures to maintain your Kenworth correctly.

Good driving practices, daily and weekly driver maintenance inspections, and periodic service inspections by an authorized Kenworth Dealer, will help keep your Kenworth in good working order and provide many years of dependable service.

	<b>WARNING!</b>
<p>It can be dangerous to attempt maintenance work without sufficient training, service manuals, and the proper tools. You could be injured, or you could make your vehicle unsafe. Do only those tasks you are fully trained and equipped to do. Failure to comply may result in personal injury, death, equipment or property damage.</p>	

## Safety Precautions

- **Before attempting any procedures in the engine compartment, stop the engine and let it cool down. Hot components can burn skin on contact.**
- **Be alert and cautious around the engine at all times while the engine is running.**
- **If work has to be done with the engine running, always (1) set the parking brake, (2) chock the wheels, and (3) ensure that the shift lever or selector is in Neutral.**
- **Exercise extreme caution to prevent neckties, jewelry, long hair, or loose clothing from getting caught in moving engine parts.**

## PREVENTIVE MAINTENANCE

---

- **Disconnect the battery ground strap whenever you work on the fuel system or the electrical system. When you work around fuel, do not smoke or work near heaters or other fire hazards. Keep an approved fire extinguisher handy.**
  - **Always support the vehicle with appropriate safety stands if it is necessary to work underneath the vehicle. A jack is not adequate for this purpose.**
  - **When working underneath the vehicle without appropriate safety stands but with the wheels on the ground (not supported), make sure that (1) the vehicle is on hard level ground, (2) the parking brake is applied, (3) all wheels are chocked (front and rear) and (4) the engine cannot be started. Remove the ignition key.**
  - **Never start or let the engine run in an enclosed, unventilated area. Exhaust fumes from the engine contain carbon monoxide, a colorless and odorless gas. Carbon monoxide can be fatal if inhaled.**
- Incomplete or improper servicing may cause problems in the operation of the vehicle. If in doubt about any servicing, have it done by your authorized Kenworth Dealer. Improper maintenance during the warranty period may also affect the warranty coverage.
- Modifying your vehicle can make it unsafe. Some modifications can affect your vehicle's electrical system, stability, or other important functions. Before modifying your vehicle, check with your Kenworth Dealer to make sure it can be done safely and correctly.

## Environmental Protection and Material Hazards

Some of the ingredients in engine oil, hydraulic oil, transmission and axle oil, engine coolant, diesel fuel, air conditioning refrigerant (R-134a and PAG oil), batteries, etc., may contaminate the environment if spilled or not disposed of properly. Non-compliance with environmental regulations can result in fines and/or jail terms. Contact your local government agency for information concerning proper disposal.



### WARNING!

This vehicle contains material known by the State of California to cause cancer and/or birth defects or other reproductive harm. This warning requirement is mandated by California law (Proposition 65) and does not result from any change in the manner in which Kenworth Truck Company vehicles are manufactured.



### CAUTION

Handle lubricants carefully. Vehicle lubricants (oil and grease) can be poisonous and cause sickness. They can also damage the paint on the vehicle.

# MAINTENANCE SCHEDULE AND LUBRICATION

## Introduction

The following section summarizes preventive maintenance and lubrication requirements for the maintenance of your Kenworth. In addition, supporting manuals and literature are included in the glove box literature package.

## Preventive Maintenance Intervals and Schedule

Your preventive maintenance program begins with daily checks you perform. See Driver's Check List on page 1-28. If your Kenworth is serviced regularly, you can avoid many large, expensive, and time-consuming repairs, as well as ensuring many years of safe and smooth operation. Also, be advised that neglect of recommended service may in some cases void your vehicle's warranty. So, for your safety and life of your vehicle, please follow Table 8, Maintenance Schedule on page 5-16. But remember, there may be maintenance operations that demands skills and equipment you do not have. If so, please take your Kenworth to an expert mechanic, for your safety and your vehicle's performance.



### WARNING!

It can be dangerous to attempt maintenance work without sufficient training, service manuals, and the proper tools. You could be injured, or you could make your vehicle unsafe. Do only those tasks you are fully trained and equipped to do. Failure to comply may result in personal injury, death, equipment or property damage.

In severe operating conditions such as earth moving, you will need to perform maintenance checks and services more frequently. Other severe operating conditions to be aware of are: where the vehicle is consistently operated under conditions of extreme temperature; conditions where heavy loads are being hauled; and contaminated environments, or steep grades. Consult the component manufacturer's maintenance manuals

## MAINTENANCE SCHEDULE AND LUBRICATION

for further information on maintenance procedures specific to these conditions.

### Maintenance and Lubrication Intervals

The following table (Recommended Lubrication Intervals) shows service intervals for Kenworth vehicles. All intervals shown are for normal and heavy-duty operations.

<b>i</b>	<b>NOTE</b>
Different lubricants or service intervals than those listed below may be required.	

**Table 6 Recommended Lubrication Intervals**

ITEM	INTERVALS	COMMENTS
Hood Pivot	None	
Front Brake Camshaft	10,000-15,000	Synthetic Grease with Special Fittings
Front Brake Camshaft	120,000	With LMS
Tie-Rod Ends	10,000-15,000	
Power Steering Reservoir - Check Fluid Level - Change Fluid & Filter	10,000-15,000	
	60,000	2 Times/Year (After Summer & Winter)
Drag Link	10,000-15,000	#2 NLGI extreme pressure, lithium-based, moly-filled, heavy duty grease with hand-operated gun only.
Steering Gear Box Trunnion	10,000-15,000	#2 NLGI extreme pressure, lithium-based, moly-filled, heavy duty grease with hand-operated gun only.
Steering U-joints	10,000-15,000	#2 NLGI extreme pressure, lithium-based, moly-filled, heavy duty grease with hand-operated gun only.

## MAINTENANCE SCHEDULE AND LUBRICATION

ITEM	INTERVALS	COMMENTS
Steering Slip Joint	10,000-15,000	#2 NLGI extreme pressure, lithium-based, moly-filled, heavy duty grease with hand-operated gun only.
Brake Treadle	10,000-15,000	
Clutch Pedal Shaft	None	
Main and Aux. Transmission - Check Fluid Level - Drain and Refill		Kenworth is Standard with Synthetic Lube (mineral gear lube optional) See manufacturer's operator's manual.
Rear Wheel Bearings - Standard	12 mo./100,000	See <a href="http://www.conmet.com">www.conmet.com</a> for maintenance details
Rear Wheel Bearings - LMS	12 mo./100,000 - Inspect 3 years/350,000 - Service	Inspect for leaks and check for end-play: 12 mo./100,000 miles. See hub manufacturer's service manual for details: <a href="http://www.conmet.com">www.conmet.com</a> If no oil leaks, then no need for service prior to 3 years/350,000 miles.
Rear Axle - Check Fluid Level - (Rear Axle) Drain, Flush, Refill		Kenworth is Standard with Synthetic Lube (mineral gear lube optional) See manufacturer's operator's manual.
Rear Brake Camshafts	10,000-15,000	Synthetic Grease with Special Fittings
Rear Brake Camshafts	120,000	With LMS
Spring Pins	10,000-15,000	With Rubber Bushed Pins - No Service
Front & Rear Slack Adjusters	10,000-15,000	Synthetic Grease with Special Fittings
King Pins	10,000-15,000	
Fifth Wheel	10,000-15,000	40,000 to 60,000 miles for Adjustment

## MAINTENANCE SCHEDULE AND LUBRICATION

ITEM	INTERVALS	COMMENTS
Front Wheel Bearings - Standard	12 mo./100,000	See <a href="http://www.conmet.com">www.conmet.com</a> for maintenance details
Front Wheel Bearings - LMS	12 mo./100,000 - Inspect 3 years/350,000 - Service	Inspect for leaks and check for end-play: 12 mo./100,000 miles. See hub manufacturer's service manual for details: <a href="http://www.conmet.com">www.conmet.com</a> If no oil leaks, then no need for service prior to 3 years/350,000 miles.
Engine Lubricating Oil - Check Fluid Level - Change Oil	Daily Trip Check	See Engine Manufacturers Recommendations
	10,000-15,000	Must Meet Engine Manufacturers Specifications
Spring Shackle Pins	10,000-15,000	No Service with Rubber Bushed Spring Pins
Clutch Linkage	10,000-15,000	
Clutch Release Bearing	10,000-15,000	Extended Grease Fittings
Clutch Cross Shaft	10,000-15,000	Extended Grease Fittings
Door Weatherstrip	100,000 or As Required	
Lock Cylinders	100,000 or As Required	
Door Hinges	100,000 or As Required	Teflon Bushing
Door Latches and Striker Plate	100,000 or As Required	
Driveline (all)		See manufacturer's operator's manual.
Center Bearing	None	

# MAINTENANCE SCHEDULE AND LUBRICATION

ITEM	INTERVALS		COMMENTS
Suspension	Per Specifications		
AG380			
AG400	None		No Lube Required
Chalmers	None		No Lube Required
Hendrickson			See Suspension Manufacturers Specifications & Recommendations - Contact your Kenworth Dealer for Preventive Maintenance Specifications/Schedule
Neway			
Reyco			

For additional Air System Scheduled Maintenance information, see Air System Scheduled Maintenance on page 5-39.

## Maintenance Schedule

Depending on the service package built into your Kenworth, use Table 8, Maintenance Schedule on page 5-16, as a guide to plan service work for Non-ESI and ESI vehicles. Be sure and follow the frequency recommendations for your vehicle.

i	NOTE
	If a scheduled service interval is shaded, skip to the next interval. The frequency of each service operation is identified by open (non-shaded areas).

## Maintenance Interval

Perform the listed operation in the shortest interval indicated. For example, if there is an "I" for Inspect listed under 15,000 mi, 60,000 mi and 120,000 mi, the shortest interval



indicated is 15,000 mi; therefore, you should inspect the operation listed every 15,000 miles. It just so happens that both 60,000 and 120,000 miles are multiples of 15,000 and the table indicates that a 15,000 mile interval will also occur at 60,000 and 120,000 miles.



## MAINTENANCE SCHEDULE AND LUBRICATION

OPERATION \ FREQUENCY	INTERVALS				COMMENTS
	7,500 mi (12,000 km)	15,000 mi (24,000 km)	60,000 mi (96,000 km)	120,000 mi (193,000 km) Annually	
Door Panels	I	I	I	I	
Headliner	I	I	I	I	
Dash	I	I	I	I	
Covers	I	I	I	I	
Wiper Operation	I	I	I	A	
Wiper Blade Condition	I	I	I	A	
Horns (Electric and Air)	I	I	I	A	
Mirrors	I	I	I	A	
<b>SAFETY EQUIPMENT</b>	<b>A</b>	<b>B</b>	<b>C</b>	<b>D</b>	
Drain Water from Air Tanks	I	I	I	I	Daily
Air Tank Check Valve	I	I	I	A	
Emergency Operation of Spring Brakes	I	I	I	A	
Air Press. Build-up time: _____ min.			I	A	
Governed Air Pressure: _____ psi			I	A	
Air Press. Drop-Brakes not Applied: ____			I	A	
Air Press. Drop-Brakes Applied: ____			I	A	
Fire Extinguisher Charge					Replace or Recharge per Extinguisher Manufacturer Recommendations

# MAINTENANCE SCHEDULE AND LUBRICATION

OPERATION \ FREQUENCY	INTERVALS				COMMENTS
	7,500 mi (12,000 km)	15,000 mi (24,000 km)	60,000 mi (96,000 km)	120,000 mi (193,000 km) Annually	
Flare Kit/Reflectors				A	
<b>CIRCLE INSPECTION</b>	<b>A</b>	<b>B</b>	<b>C</b>	<b>D</b>	
Physical Damage:					
Exterior Sheet Metal	I	I	I	I	
Grille and Radiator	I	I	I	I	
Trailer Light Cord and Connectors	I	I	I	A	
Air Lines and Gladhands	I	I	I	A	
Pintle - Hook/Eye Condition	I	I	I	A	
5th Wheel Mounting and Condition	I	I	I	A	
Headlights - High and Low Beams	I	I	I	A	
Road Lights	I	I	I	A	
Marker Lights	I	I	I	A	
Turn Signals	I	I	I	A	
Emergency Flasher	I	I	I	A	
Brake Lights	I	I	I	A	
Backup/Loading Lights	I	I	I	A	
License Plates: Permits and Mounting	I	I	I	A	

5

## MAINTENANCE SCHEDULE AND LUBRICATION

OPERATION \ FREQUENCY	INTERVALS					COMMENTS
	7,500 mi (12,000 km)	15,000 mi (24,000 km)	60,000 mi (96,000 km)	120,000 mi (193,000 km) Annually		
Mud Flaps/Serviceable	I	I	I	A		
Fuel Tank Mounting	I	I	I	A		
Exhaust System-Condition and Mounting Bolts	I	I	I	A		
Frame Fastener Torque:			I	A		See Table Key on page 5-16.
Lubricate: Door Hinges and Latches			I	I		
Body Mounts (Straight Truck Only)			I	I		
Body Sides and Roof Panels (Straight trucks)			I	I		
Cab Air Suspension Mounts			I	I		See Manufacturers Recommendations
Hood: Hold Down Latches			I	I		Replace if Damaged
Safety Lock			I	I		Replace as Required
Front Pivot Assembly			I	I		

# MAINTENANCE SCHEDULE AND LUBRICATION

OPERATION \ FREQUENCY	INTERVALS				COMMENTS
	7,500 mi (12,000 km)	15,000 mi (24,000 km)	60,000 mi (96,000 km)	120,000 mi (193,000 km) Annually	
ENGINE SERVICE	A	B	C	D	
Engine Oil - Change					See Engine Manufacturers Operator Manual provided with this chassis
Engine Oil Level					
Oil Filters					
Fuel Filters					
Diesel Particulate Filter (DPF)					
Drain Water from Fuel System					
Engine Tune-up					
Cooling: Check Supplemental Additive/ Conditioner to Manufacturer Specifications _____%					
Coolant Level	I	I	I	I	
Coolant Protection: _____ degrees			I	I	
Pressure Test		I	I	I	Check at Time of Coolant Replacement
Replace Water Filter				R	New Release at 100-120K - per Engine Filter Manufacturer Recommendations
Hose Condition and Connections		I	I	I	
Radiator Mounting			I	I	

## MAINTENANCE SCHEDULE AND LUBRICATION

OPERATION \ FREQUENCY	INTERVALS					COMMENTS
	7,500 mi (12,000 km)	15,000 mi (24,000 km)	60,000 mi (96,000 km)	120,000 mi (193,000 km) Annually		
Fan Shroud			I	I		
Ring Shroud			I	I		
Fan Assembly and Idler Pulley			I	I		No Service Required on ESI Units
Check Water Pump for Leaks/Play			I	I		
Radiator - Exterior Condition						Once every 240,000 Miles (384,000 km)
Replace Engine Coolant						For coolant replacement, please see engine Operator's Manual included with this chassis
Charge Air Cooler Piping (CAC)		*				Tighten clamps after the first 500 miles (800 km). * See Pipe and Hose Clamp Torque Values on page 5-93.
Air Cleaner:				R		Replace Annually/Air Cleaner Restriction: Replace if Greater Than 20
Air Intake Pipe Clamps		*				Tighten clamps after the first 500 miles (800 km). * See Pipe and Hose Clamp Torque Values on page 5-93.
Contaminant Accumulation			I	I		Check Every 15,000 Miles (24,000 km) in Dirty Conditions

# MAINTENANCE SCHEDULE AND LUBRICATION

OPERATION \ FREQUENCY	INTERVALS				COMMENTS
	7,500 mi (12,000 km)	15,000 mi (24,000 km)	60,000 mi (96,000 km)	120,000 mi (193,000 km) Annually	
Air Cleaner Restriction ___ (replace if greater than 20)		I	I	I	
Vacuator Valve-Operation & Condition			I	I	
Mounting Bolts			I	I	
Leaks			I	I	
Interference			I	I	
Hose Condition and Connections		I	I	I	Check for Leaks and Cracking
Power Steering - Reservoir Level	I	I	I	I	
Power Steering Fluid - Replace			R	R	Service 2 Times per Year - 60,000 Mile Intervals
Power Steering Filter - Replace			R	R	See Table Key on page 5-16
Fan and Accessory Drive Belt(s) Condition		I	I	I	For details on belt replacement see the Engine Operator's Manual included with this chassis.
Air Conditioner Compressor Mounting			I	I	
Cold Start Aids		I	I	I	
Governor and Pump Security Seals OK				A	
High Idle: _____ RPM				A	
Emergency Shutdown		I	I	I	



## MAINTENANCE SCHEDULE AND LUBRICATION

OPERATION \ FREQUENCY	INTERVALS				COMMENTS
	7,500 mi (12,000 km)	15,000 mi (24,000 km)	60,000 mi (96,000 km)	120,000 mi (193,000 km) Annually	
Vibration Damper Condition			I	I	
Cranking System: Check Harness/Cables For Loose Connections, Chafing, Broken Retention Clips Starter Draw: _____ volts		I	I	I	
Alternator/Charging System: Check Harness/Cables For Loose Connections, Chafing, Broken Retention Clips Output Voltage: _____ volts		I	I	I	To ensure proper inspection it may be necessary to inspect under and inside frame rails and unclip harness/cable bundles.
			I	A	
Exhaust System	I				Check for leaks and proper support.
Engine Mounting			I		Inspect engine mounts every 60,000 miles (96,560 km) (shown on page 5-97). Contact an authorized vehicle OEM dealership if engine mounts need servicing.
<b>FRONT COMPONENTS</b>	<b>A</b>	<b>B</b>	<b>C</b>	<b>D</b>	
Steering Components Condition:	I	I	I	I	
Steering Gear			I	A	
Steering Shaft Splines and Joint(s)	I	I	I	A	

# MAINTENANCE SCHEDULE AND LUBRICATION

OPERATION \ FREQUENCY	INTERVALS				COMMENTS
	7,500 mi (12,000 km)	15,000 mi (24,000 km)	60,000 mi (96,000 km)	120,000 mi (193,000 km) Annually	
Pitman Arm		I	I	A	
Drag Link		I	I	A	
Steering Arms		I	I	A	
Tie Rod Arms		I	I	A	
Tie Rod Ends		I	I	A	
Radius Rods/Torque Arms		I	I	A	
Chassis Frame Cracks or Breaks	I	I	I	A	
Spring Shackles and Hanger Brackets			I	A	No Service Required on ESI Units
Spring Pins		I	I	A	No Service Required on ESI Units
King Pin Wear				I	
Steering Axle Wheel Bearing - End Play Adjustment and Inspection	I	I	I	I	Inspect for leaks and check for end-play: 12 mo./100,000 miles. See hub manufacturer's service manual for details: <a href="http://www.conmet.com">www.conmet.com</a> If no oil leaks, then no need for service prior to 3 years/350,000 miles.
Front Hub Lubricant Level		I	I	A	
Spring Leaves			I	A	

5

## MAINTENANCE SCHEDULE AND LUBRICATION

OPERATION \ FREQUENCY	INTERVALS					COMMENTS
	7,500 mi (12,000 km)	15,000 mi (24,000 km)	60,000 mi (96,000 km)	120,000 mi (193,000 km) Annually		
Air Springs - AG130		I	I	A		See Front Suspension U-Bolt torque. on page 5-105
U-Bolt and Suspension Fastener Torque		I	I	I		Tighten U-bolts after the first 500 miles (800 km). See Table Key on page 5-16.

# MAINTENANCE SCHEDULE AND LUBRICATION

OPERATION \ FREQUENCY	INTERVALS				COMMENTS
	7,500 mi (12,000 km)	15,000 mi (24,000 km)	60,000 mi (96,000 km)	120,000 mi (193,000 km) Annually	
<b>REAR COMPONENTS</b>	<b>A</b>	<b>B</b>	<b>C</b>	<b>D</b>	
Rear Suspension Components - Condition					For Kenworth Non-Proprietary Suspensions, See your Kenworth Dealer for Preventive Maintenance Specifications/Schedule.
Track/Torque Rods					
Suspension Brackets & Welds - Cracks					
Springs, Hangers & Shackles					
Walking Beams					
Bushings - Worn					
Air Springs & Mounts					
Lubrication					
Suspension Air Fittings - Leaks					
U-Bolt and Suspension Fastener Torque					For other suspension, "see manufacturers recommendations". Rear suspension fasteners: re-torque after first 2,000 miles (3,218 km). See Rear Suspension U-Bolt torque on page 5-122.
Leaks:					
Coolant					

## MAINTENANCE SCHEDULE AND LUBRICATION

OPERATION \ FREQUENCY	INTERVALS				COMMENTS
	7,500 mi (12,000 km)	15,000 mi (24,000 km)	60,000 mi (96,000 km)	120,000 mi (193,000 km) Annually	
Engine Oil	I	I	I	A	
Power Steering	I	I	I	I	
Fuel	I	I	I	I	
Transmission	I	I	I	I	See manufacturer's operator's manual.
Axles	I	I	I	I	
Inner and Outer Hub Seals	I	I	I	I	
Engine and Transmission Mounts			I	I	
Drivelines - U-joints and Slip Yokes			I	I	
Rear Axle Lubricant Level		I	I	I	
Rear Axle Lubricant Flush & Refill					Non-ESI - 250,000 Miles/ESI - 500,000 Miles. See Table Key on page 5-16.
Rear Axle Breathers - Clear	I	I	I	I	
Vehicle Protection Valve Breakaway Test	I	I	I	I	
Brake Chamber Mounting Bolt Torque		I	I	A	
Brake Hoses for Cracks and Chafing	I	I	I	A	
Adjust Brakes		I	I	A	

# MAINTENANCE SCHEDULE AND LUBRICATION

OPERATION \ FREQUENCY	INTERVALS				COMMENTS
	7,500 mi (12,000 km)	15,000 mi (24,000 km)	60,000 mi (96,000 km)	120,000 mi (193,000 km) Annually	
Front & Rear Brake Camshaft Tube Lubrication			I	A	Synthetic Grease Required - Special Fitting
Clutch Pedal Shaft			I	I	No Service Required on ESI Units
Clutch Linkage			I	I	
Suspension Air Fittings		I	I	I	
Clutch Release Bearing				A	Required Extended Fittings
Driveline Center Bearing			I	I	No Service Required on ESI Units
Automatic Slack Adjusters	I	I	I	I	Standard (non-LMS)
Automatic Slack Adjusters				I	With LMS, Synthetic Lube Required - Special Fitting
Brakes: Lining Remaining (replace as required)		I	I	A	
RF _____ RRF _____ RRR _____					
LF _____ LRF _____ LRR _____					

5

## MAINTENANCE SCHEDULE AND LUBRICATION

OPERATION \ FREQUENCY	INTERVALS					COMMENTS
	7,500 mi (12,000 km)	15,000 mi (24,000 km)	60,000 mi (96,000 km)	120,000 mi (193,000 km) Annually		
Drum Condition: RF _____ RRF _____ RRR _____			I	A		
LF _____ LRF _____ LRR _____						
Chassis Lubrication						
Transmission Lubricant Level						See manufacturer's operator's manual.
Transmission Lubricant and Filter Change				A		See manufacturer's operator's manual.
Rear Axle Lubricant Change				A		See manufacturer's operator's manual.
Front Hub Lubricant Change				A		See manufacturer's operator's manual.
<b>BATTERIES</b>	<b>A</b>	<b>B</b>	<b>C</b>	<b>D</b>		
Check Harness/Cables For Loose Connections, Chafing, Broken Retention Clips		I	I	I		To ensure proper inspection it may be necessary to inspect under and inside frame rails and unclip harness/cable bundles.
Signs of Over-Charging			I	I		
Remove Corrosion and Seal Terminals			I	I		

# MAINTENANCE SCHEDULE AND LUBRICATION

OPERATION \ FREQUENCY	INTERVALS				COMMENTS
	7,500 mi (12,000 km)	15,000 mi (24,000 km)	60,000 mi (96,000 km)	120,000 mi (193,000 km) Annually	
Hold-down and Box - Mounting Bolts					
Load Test Batteries				A	
Sealed Type - Condition:					
(Color of charge indicator for each battery)					
1 _____ 2 _____ 3 _____					
<b>TIRES AND WHEELS</b>	<b>A</b>	<b>B</b>	<b>C</b>	<b>D</b>	
Missing Valve Caps and Stem Locks					
Cracks or Loose Wheel lugs				A	
Tandem Mating					
Irregular Wear				A	
Tire Pressure (Record below)					
Remaining Tread (Record below)				A	
Tires & Wheels Inspection				A	

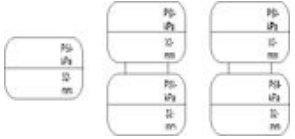
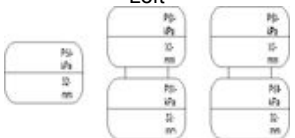

# MAINTENANCE SCHEDULE AND LUBRICATION

OPERATION \ FREQUENCY	INTERVALS					COMMENTS
	7,500 mi (12,000 km)	15,000 mi (24,000 km)	60,000 mi (96,000 km)	120,000 mi (193,000 km) Annually		
<b>Right</b> 						
<b>Left</b> 						
Air Pressure Adjusted to: _____						

# MAINTENANCE SCHEDULE AND LUBRICATION

OPERATION \ FREQUENCY	INTERVALS				COMMENTS
	7,500 mi (12,000 km)	15,000 mi (24,000 km)	60,000 mi (96,000 km)	120,000 mi (193,000 km) Annually	
<b>ALIGNMENT</b>	<b>A</b>	<b>B</b>	<b>C</b>	<b>D</b>	
Toe-in: _____ in (mm)		I	I		
Caster: L _____ R _____		I	I		
Rear Axle Alignment		I		A	
<b>ROAD TEST</b>	<b>A</b>	<b>B</b>	<b>C</b>	<b>D</b>	
Steering/Steering Play	I	I	I	I	
Shifting		I	I	I	
Brakes		I	I	I	
Engine Operation (noises, surging, black smoke)		I	I	I	
Throttle Linkage	I	I	I	I	
Engine Brake Operation		I	I	I	
Seat Belts		I	I	I	
Air Seat Operation		I	I	I	
Cab Heater		I	I	I	
Air Conditioner			I	I	
Instruments and Gauges:					
Speedometer/odometer		I	I	I	

## MAINTENANCE SCHEDULE AND LUBRICATION

OPERATION \ FREQUENCY	INTERVALS				COMMENTS
	7,500 mi (12,000 km)	15,000 mi (24,000 km)	60,000 mi (96,000 km)	120,000 mi (193,000 km) Annually	
Tachometer					
Oil Pressure					
Engine Temperature					
Illumination					
SRS Warning					
ABS Warning					
Low Brake Pressure Warning Devices				A	

### Lubrication Specifications

You will find a complete Engine Lubrication Service Guide in the Engine Operation and Maintenance Manual. There, the engine manufacturer explains more fully all the maintenance operations you and a qualified service mechanic will need. And please remember: one key to keeping your Kenworth running at top economy and in prolonging its life is proper

lubrication servicing. Neglecting this essential aspect of vehicle care can cost time and money in the long run.

Below you will find basic information needed to perform routine vehicle lubrication. Of course you will want to schedule service more frequently if operating in severe conditions such as extreme heat or cold, with very heavy loads, off-road, etc. For any special service requirements, consult your service manuals and your lubricant supplier. The component manufacturer's specification and

# MAINTENANCE SCHEDULE AND LUBRICATION

requirements take precedence over other specifications.



## CAUTION

Handle lubricants carefully. Vehicle lubricants (oil and grease) can be poisonous and cause sickness. They can also damage the paint on the vehicle.



## CAUTION

Do not mix different types of lubricants. Mixing lubricants (oil and grease) of different brands or types could damage vehicle components; therefore, drain (or remove) old lubricants from the unit before refilling it.

## Oil Reservoirs

For oil reservoirs with side filler plugs (transmissions, axles, steering gear boxes, transfer cases, etc.), the oil must be level with the filler opening.



## NOTE

Use care when checking the oil level with a finger. Just because you can reach the oil level with a finger, does not mean the oil level is correct.



## NOTE

Factory oil level may be above this level because it is measured as a volume and not as a specific oil level. This is acceptable to the axle manufacturers; however, refill should be per the Proper Oil Level as shown in the figure below.

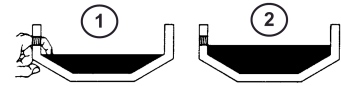

- 1 Improper Oil Level
- 2 Proper Oil Level

# MAINTENANCE SCHEDULE AND LUBRICATION

## Lubrication Chart

The following lubrication specifications (Table 10) are for an ambient operating

temperature range of -15° to 100° F (-26° to 38° C). For extreme temperature operations, consult the component manufacturers manuals.

**Table 10 Recommended Lubrication Types \* Non-ESI Units**

COMPONENTS	RECOMMENDED LUBRICANT
Power Steering Gear	ATF Dexron® III
Manual Steering Gear	SAE 80W-90 CP gear oil, miL-L-2105D, API GL5.
Slip-Joint Splines Hood Pivots Fan Drive Clutch Pedal Shaft Clutch Linkage Other chassis grease fittings not covered below.	EP chassis grease, lithium 12-hydroxystearate or lithium complex base, NLGI 2.
Wheel Bearings-Non Driving Axles Including Steerable Pushers and Tag Axles	OIL LUBRICATED: SAE 80W-90 EP gear oil, miL-L-2105D, API GL5; or SAE 50 Synthetic Transmission Oil (CD50).
	GREASE LUBRICATED: EP chassis grease, lithium 12-hydroxystearate or lithium complex base, NLGI 2.
Wheel Bearings-Non Steerable Pushers and Tag Axles	OIL LUBRICATED: SAE 80W-90EP gear oil, miL-L-2105D, API GL5; or SAE 75W-90 Synthetic Oil
	GREASE LUBRICATED: EP chassis grease, lithium 12-hydroxystearate or lithium complex base, NLGI 2.
Threaded Pins & Bushings (e.g., spring pins & bushings)	EP grease, lithium 12-hydroxystearate or lithium complex base, NLGI 2, with 3% molybdenum additive: Mobil Grease Special (Mobil), Molygrease EP (Chevron), or equal.

## MAINTENANCE SCHEDULE AND LUBRICATION

COMPONENTS	RECOMMENDED LUBRICANT
Suspension Fittings (other than threaded pins & bushings)	EP chassis grease, lithium 12-hydroxystearate or lithium complex base, NLGI 2.
Steering Axle: Grease Fittings on Steering Arm; Tie Rod Ends; Drag Link; King Pins	EP chassis grease, lithium 12-hydroxystearate base, NLGI 2.
Clutch Release Bearing (remove inspection plate for access); Driveshaft Center Bearing	High temperature ball bearing grease. Chevron SRI Mobil Grease HP, Texaco Multifax 2, or equivalent.
Manual Slack Adjusters	EP chassis grease, lithium 12-hydroxystearate base, NLGI 2.
Automatic Slack Adjusters; Wedge Brake Components; Disc Brake Caliper	High temperature EP grease; Texaco Thermotex EP-1, Shell Darina EP-1, Mobilith AW-1, Meritor 0-616A, or equivalent.
Cam Brake Camshaft Splines; Disc Brake Shaft Splines and Slide Pin Retainers; Brake Clevis Pins	Anti-seize type grease, Meritor specification 0-637.
Brake Camshaft Bushings	EP Chassis grease, lithium 12-hydroxystearate base, NLGI 2.
	 <b>CAUTION</b>
	Do not contaminate brake linings with grease.
Steering Shaft Grease Fittings	EP chassis grease, lithium 12-hydroxystearate base, NLGI 2.
Brake Treadle Hinge and Roller	Engine oil
Lock Cylinders	Lock lubricant.
Door Hinges	Not required - Teflon bushings
Door Latches & Striker Plates	Polyethylene grease stick.
Door Weatherstrip	Silicone lubricant.

## MAINTENANCE SCHEDULE AND LUBRICATION

COMPONENTS	RECOMMENDED LUBRICANT
Axle U-Bolt Threads	Chevron Zinc Lubrication anti-seize compound is recommended; or use EP chassis grease, lithium 12-hydroxystearate or lithium complex base, NLGI 2
Hub-piloted Aluminum Wheels	Coat the wheel pilot or hub pads with Freylube #3 lubricant (light colored) or Chevron Zinc lube. Do not get lubricant on the face of the wheel or the hub.
Other Items	Use manufacturers manuals.

## AIR SYSTEM MAINTENANCE

### Introduction

5



#### WARNING!

Prior to the removal of any air system component, always block and hold the vehicle by a secure means other than the vehicle's own brakes. Depleting air system pressure may cause vehicle to roll unexpectedly resulting in an accident. Keep hands away from chamber push rods and slack adjusters, they may apply as system pressure drops. Failure to comply may result in personal injury, death, equipment or property damage.

- **Never connect or disconnect a hose or line containing air pressure. It may whip as air escapes. Never remove a component or pipe plug unless**

**you are certain all system pressure has been depleted.**

- **Never exceed recommended air pressure and always wear safety glasses when working with air pressure. Never look into air jets or direct them at anyone.**
- **Never attempt to disassemble a component until you have read and understood recommended procedures. Some components contain powerful springs and injury or death can result if not properly disassembled. Use only proper tools and observe all precautions pertaining to the use of those tools.**



#### WARNING!

Do not release the parking brake or attempt to move the vehicle until air pressure in both circuits is at least 100 psi (689 kPa), the level required for normal brake operation. Failure to comply may result in personal injury, death, equipment or property damage.

- **Do not use the trailer hand brake control to hold vehicle while parked. This control utilizes air pressure for brake application. Because acceptable air leakage levels cause all truck air systems to gradually lose pressure, vehicle rollaway could occur, resulting in an accident, injuries or death.**
- **Always apply the vehicle and trailer parking brakes when the vehicle is unattended.**



Contamination of the air supply system is the major cause of problems in air-operated components such as brake valves, wiper motors,

and suspension height control valves. To keep contaminants to the lowest possible level, follow these maintenance procedures.

## Scheduled Maintenance

Use the following table, to schedule service operations and air system tests.

**Table 11 Air System Scheduled Maintenance**

TEST	MAXIMUM INTERVALS				
	EACH WEEK	EACH MONTH (10,000 mi) (16,000 km)	THREE MONTHS (25,000 mi) (40,000 km)	SIX MONTHS (50,000 mi) (80,000 km)	ANNUALLY (100,000 mi) (160,000 km)
Air Compressor			•		
Air Dryer			•		
Air Governor			•		
System Leakage	•				
Dual Air Brake Treadle Valve			• — or — •		
Hand Operated Trailer Brake Valve			• — or — •		
Vehicle Parking Valve			•		
Parking Brake Valve			•		
Trailer Air Supply			•		
Vehicle Protection Valves					•
Relay Valve					•

## AIR SYSTEM MAINTENANCE

TEST	MAXIMUM INTERVALS				
	EACH WEEK	EACH MONTH (10,000 mi) (16,000 km)	THREE MONTHS (25,000 mi) (40,000 km)	SIX MONTHS (50,000 mi) (80,000 km)	ANNUALLY (100,000 mi) (160,000 km)
Spring Brake Inversion Valve					•
Automatic Limiting Valve					•
Single Check Valves				•	
Double Check Valves	•				
Stop Light Switch				•	
Low Pressure Wig Wag	•				
Low Pressure Switch		•			
Automatic Drain Valve		•			
Safety Valve			•		
Quick Release Valve					•
Manual Drain Valve				•	

### Air System Function Test

Scheduled maintenance should be performed on the Kenworth's air system, as outlined on Table 11. In addition, perform an Air System Function Test at least every 3 months

or if there is any indication of a potential problem.

## Air Tanks

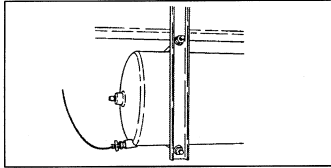

To eject moisture from the air system tanks, pull the line which is connected to the moisture ejection valve. Continue pulling until the air comes out free of water.

**Daily:** The supply and service air tanks, must be drained on a daily basis. Operate air devices daily to circulate lubricants within the unit.

**Periodically:** Clean filter screens ahead of the valves by removing the screens and soaking them in solvent. Blow them dry with pressurized air before reinstalling them.

	<b>WARNING!</b>
<p>If the supply and service air tanks are not drained at the recommended frequency, water could enter the air lines and valves. This could cause corrosion or blockage, which could compromise the brake system safety and potentially cause an accident. Failure to comply may result in personal injury, death, equipment or property damage.</p>	

	<b>CAUTION</b>
<p>Do not use penetrating oil, brake fluid, or wax-based oils in the air system. These fluids may cause severe damage to air system components.</p>	

- Maintain the air compressor to prevent excessive oil bypass.
- Replace worn seals in valves and air motors as they are needed. Your Kenworth Dealer carries rebuild kits for most units.

## Air Gauges and Air Leaks

Your Kenworth comes with two separate air pressure gauges for two separate systems, Primary and Secondary: the Primary gauge indicates pressure in the rear braking system; the Secondary gauge indicates pressure in the front braking system. Each gauge indicates the amount of air pressure in pounds per square inch (psi).

	<b>WARNING!</b>
<p>Do not operate the vehicle if leakage in the air system is detected. Failure to check the brakes or follow these procedures could cause a system failure, increasing the risk of an accident and may result in personal injury, death, equipment or property damage.</p>	

If the light and alarm do not turn off at start-up, do not try to drive the vehicle until the problem is found and fixed. If

## AIR SYSTEM MAINTENANCE

the pressure in either or both systems is too low for normal brake operation, i.e., the pointer of one gauge falls below 60 psi (414 kPa), a warning light on the gauge will glow and the audible alarm will sound.

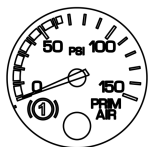

Primary Air Pressure Gauge

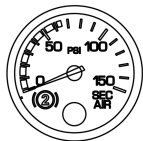

Secondary Air Pressure Gauge

**Follow the procedure below to check the compressed air system for leaks:**

1. Periodically, or after maintenance or replacement of air system components:
2. Build up air pressure in the system to the governor cutout point or until 120 psi (827 kPa) is reached.
3. Stop the engine and release the service brakes.
4. Without applying the brake pedal, observe the rate of air pressure drop. This rate should not exceed 2.0 psi (14 kPa) per minute.
5. Start the engine and build up the air pressure again.
6. Stop the engine, and apply the brakes fully. Apply the brake pedal and hold it down for five minutes. The pressure drop should not exceed 3.0 psi (21 kPa) per minute.
7. If you detect excessive leakage (air pressure loss greater than 3.0

psi (21 kPa) after five minutes of brake application), a leakage test should be made at the air line connections and at all air brake control units. These tests should determine where air is escaping.

### Air Compressor Operation

All compressors, regardless of make or model, run continuously while the engine is running. System pressure is controlled by the governor. The governor acts in conjunction with the unloading mechanism in the compressor cylinder block to start and stop compression of air. The compressor is unloaded when the system pressure reaches 120 psi (827 kPa) and compression is reestablished when system pressure falls to 100 psi (689 kPa).

### Preventive Maintenance

The following service checks are provided for your information only and should be performed by a certified mechanic. Contact your Kenworth Dealer or the engine manufacturer's Maintenance Manual for further information on servicing air compressors.

After completing any repairs to the air system, always test for air leaks, and check the brakes for safe operation before putting the vehicle in service.

According to Table 11, Air System Scheduled Maintenance on page 5-39:

- Inspect compressor air filter element, if so equipped, and replace element if clogged. Check compressor mounting and drive for alignment and belt tension. Adjust if necessary.

- Remove compressor discharge valve cap nuts and check for presence of excessive carbon. If excessive carbon is found, clean or replace the compressor cylinder head. Also, check compressor discharge line for carbon, and clean or replace the discharge line if necessary.
- Disassemble compressor and thoroughly clean and inspect all parts. Repair or replace all worn or damaged parts, or replace compressor with a factory exchange unit.



## CAUTION

When draining the engine cooling system is required, to prevent damage from freezing, the compressor must also be drained at the cylinder head and block. Engine damage could occur if the cooling system is not periodically drained and maintained. See Cooling System on page 5-65 for further information.

## Air Dryer

The function of the air dryer is to collect and remove air system contaminants in solid, liquid and vapor form before they enter the brake system. It provides clean, dry air to the components of the brake system, which increases the life of the system and reduces maintenance costs.



## NOTE

Because no two vehicles operate under identical conditions, maintenance and maintenance intervals will vary. Experience is a valuable guide in determining the best maintenance interval for any one particular operation.

Every 900 operating hours or 25,000 miles or every three (3) months check for moisture in the air brake system by opening air tanks, drain cocks, or

valves and checking for presence of water.



## NOTE

A small amount of oil in the system may be normal and should not, in itself, be considered a reason to replace the desiccant cartridge. Oil stained desiccant can function adequately.

A tablespoon of water found in the air tank would point to the need for a desiccant cartridge change. However, the following conditions can also cause water accumulation and should be considered before replacing the desiccant cartridge.

- Air usage is exceptionally high and not normal for a highway vehicle. This may be due to accessory air demands or some unusual air requirement that

does not allow the compressor to load and unload (compressing and non-compressing cycle) in a normal fashion or it may be due to excessive leaks in the air system.

- In areas where more than a 30° F (17° C) range of temperature occurs in one day, small amounts of water can accumulate in the air brake system due to condensation. Under these conditions, the presence of small amounts of moisture is normal and should not be considered as an indication that the dryer is not performing properly.
- An outside air source has been used to charge the air system. This air did not pass through the drying bed.

## Overhaul

Maintenance intervals typical for on-highway operation would be 2 - 3 years, 350,000 miles or 10,800 hours.

Maintenance intervals typical for high duty cycle usage such as transit bus, refuse hauler, dump truck, cement mixers and off-highway operation would be 1 year, 100,000 miles or 3,600 hours.

	<b>NOTE</b>
Review the warranty policy before performing any maintenance procedures. An extended warranty may be voided if unauthorized maintenance is performed during this period.	

## Bendix AD-IS Series Air Dryer

Your Kenworth vehicle may be equipped with a Bendix AD-IS series air dryer. Any air dryer replacement should be made with an identical component.

	<b>WARNING!</b>
If a different air dryer brand or model is installed on the vehicle other than what was originally installed, it could cause the air system to not perform correctly unless the full air system design is reviewed and modifications made to comply with Federal Motor Vehicle Safety Standards (FMVSS 121 - Air Brake Systems) or, in the case of chassis equipped with the European air system, ECE R13. Failure to abide by this warning and maintain compliance to FMVSS 121 or ECE R13 could cause loss of vehicle control and may lead to personal injury or death.	

<b>i</b>	<b>NOTE</b>
The AD-IS Series air dryer has incorporated into its design various components that have typically been installed separately on the vehicle.	

See below for components/areas affected.

- Pressure protection valves
- Safety valve
- Governor and plumbing
- Plumbing of the front and rear service air tanks
- Plumbing to accessory systems

These components are required to meet the Federal Motor Vehicle Safety Standards (FMVSS 121 - Air Brake Systems) or, in the case of chassis equipped with the European air system, ECE R13. As the Warning

above states, any other type of air dryer installed in the place of an AD-IS Series will require changes, modifications, and/or additions to your vehicle's air system to maintain compliance with FMVSS 121 or ECE R13. Kenworth strongly recommends that if the air dryer is changed from an AD-IS series, you consult your nearest authorized Kenworth dealer.

### Air Intake System

Engine heat, vibration, and age combine to loosen air intake connections and cause cracks in the tubing and elbows. Leaks in the intake system allow abrasive dust to enter the engine and quickly cause expensive damage. During your daily walk-around inspection, carefully check all tubing, elbows, clamps supports and fasteners for condition and tightness.

- Check the Charge-Air-Cooler for air leaks annually. The air leaks can be caused by cracked tubes or header. For service see your authorized Kenworth Dealer.





## CAUTION

Do not use air intake pipes and connections as a step or to pull yourself up. This could loosen the connections and open the system to unfiltered air which could damage the engine.

## Turbocharger

When servicing the air intake and exhaust systems on a turbocharged engine, check the items listed below.



## WARNING!

Do not operate engine with turbocharger intake piping disconnected. A suction is created when the engine is running. This suction could draw your hand or anything else near it into the impeller fan. You could be injured. Always keep the intake piping connected when you will be running the engine.

**High Frequency Vibration:** Vibration may indicate turbo rotor imbalance. Have your Kenworth Dealer investigate this immediately. If you detect any deficiencies, take the vehicle to an authorized Kenworth Dealer for servicing. Delay could lead to severe and expensive damage to your vehicle.

**Lubricating System:** Check the oil lines, housing, and connections. Look for leaks, damage, or deterioration. Leaks could mean you have damaged oil lines or oil seals.

**Manifold:** With the engine operating, check for leaking manifold or flange gaskets.

# AIR SYSTEM MAINTENANCE

---

## Air Cleaners and Filter Replacement

The following service information is basic to all air cleaner makes and models. Service the filter elements when the (option) locks in the extreme High position. Have the element serviced at an authorized Kenworth Dealer. Paper elements require care and proper handling, because they are critical to engine service life.

Service the air cleaner periodically. If the vehicle operates in areas with heavy dust, maintenance should be more frequent.

5

## BRAKE SYSTEM MAINTENANCE

### Introduction

To operate your vehicle safely, you need some understanding of its brake systems. Brake adjustment and brake balance must be set carefully to allow equal stopping forces at all wheels. Tires are also a very important part of the whole system. How fast you can stop depends on how much friction there is between the road and your tires.

**All of the following areas are interrelated and must conform to original specifications:**

- tire size
- cam radius
- wedge angle
- drum radius

- brake linings
- brake chambers
- slack adjusters

i	NOTE
<p>The air brake system of this vehicle was configured for ONE of the following operations, TRACTOR or TRUCK, and complies with the respective portions of Federal Motor Vehicle Safety Standards (FMVSS 121 - Air Brake Systems) or, in the case of chassis equipped with the European air system, ECE R13. <b>A tractor shall not be operated or configured as a truck, nor shall a truck be operated or configured as a tractor without significant modifications to the air brake system in order to retain compliance with FMVSS 121 or ECE R13.</b> Contact your Kenworth dealer for instructions.</p>	

Once a brake system is set to specifications, changing any one of its components or any combination of components may cause the system not to work as well. All parts have to work together to perform as they should.

Because your brake system is air operated, see Air System Maintenance on page 5-38 for more information on checking your brakes.

Any replacement components in the brake system should be the same or better than the original components. Any changes from the original specifications can affect the performance of the entire system.

# BRAKE SYSTEM MAINTENANCE

5

 <b>WARNING!</b>
Do not use any replacement part in the brake system unless it conforms exactly to original specifications. A nonconforming part in your vehicle's brake system could cause a malfunction resulting in an injury accident. Sizes and types are so related to one another that a seemingly unimportant change in one may result in a change in how well the brakes work for you on the road. If parts do not work together properly, you could lose control of your vehicle, which could cause a serious accident. Failure to comply may result in personal injury, death, equipment or property damage.

 <b>WARNING!</b>
Do not work on the brake system without the parking brake set and wheels chocked securely. If the vehicle is not secured to prevent uncontrolled vehicle movement, it could roll and may result in personal injury, death, equipment or property damage.

 <b>CAUTION</b>
Use wood blocks (4 in. X 4 in. or larger) against the front and rear surfaces of the tires. Be sure the vehicle cannot move.

## Lubrication

Cam-actuated brake components such as anchor pins and brake camshafts are subjected to high temperatures, and must be lubricated with non-melting, water resistant brake grease meeting R-S Specification 0-616 (NLGI-Grade 1).

- Lubricate according to Table 6, Recommended Lubrication Intervals on page 5-11.

 <b>WARNING!</b>
Do not apply too much lubricant to brake components, lubricate sparingly. Excessive amounts of lubricant could contaminate brake linings, which could reduce brake effectiveness and cause an accident. Failure to comply may result in personal injury, death, equipment or property damage.

## Brake and Slack Adjuster Lubrication

According to the interval, pressure lubricate the slack adjuster and brake camshaft (bracket/tube). Two grease fittings are provided for both the slack adjuster and camshaft bracket/tube.

- Use standard chassis lubricant (meeting No. 1 grade high temperature, water proof specifications).
- Do not use moly-disulfide loaded grease or oil (they may shorten the service life of the slack adjuster).
- Do not use pressure-release grease fittings when lubricating the slack adjuster.

## Checks and Adjustments

All vehicle Operator's should check the brakes regularly. Always adjust the brakes when they are cool.

- Park the vehicle on a level surface and block the wheels before attempting any brake checks or adjustments.

## Brake Linings



### WARNING!

Do not use brake linings with a thickness below the specified minimum. Such linings will have lining rivets exposed that can damage the brake drum and reduce brake efficiency, which could cause an accident or system failure. Failure to comply may result in personal injury, death, equipment or property damage.

- Brake linings should be inspected by a qualified mechanic at an authorized Kenworth Dealer for wear. See Table 9, Maintenance Schedule on page 5-16. In severe service applications inspect the linings more frequently.



### NOTE

Depending on your vehicles service package (ESI or Non-ESI), brake service requirements will vary.

# BRAKE SYSTEM MAINTENANCE

## Automatic Slack Adjusters

Your Kenworth is equipped with automatic brake (slack) adjusters.



### WARNING!

Do not work on the brake system without the parking brake set and/or the wheels chocked securely. If the vehicle is not secured to prevent uncontrolled vehicle movement, it could roll and may result in personal injury, death, equipment or property damage.



### CAUTION

Use wood blocks (4 in. X 4 in. or larger) against the front and rear surfaces of the tires. Be sure the vehicle cannot move.

1. Check brakes when the temperature of the service brake linings are cool and the system air pressure at 100 psi (689 kPa) minimum.



### NOTE

Chock the tires before proceeding.

2. Release the parking brakes to allow the slack adjusters to retract.
3. Measure the retracted pushrod length from the face of the brake chamber to the center of the pushrod pin.
4. Apply 80 to 90 psi (552 to 621 kPa) brake application and measure the same distance.
5. The difference is the pushrod travel distance (applied stroke).
6. Verify that the result is within the correct range. See the following

Brake Adjuster Stroke table for acceptable limits.

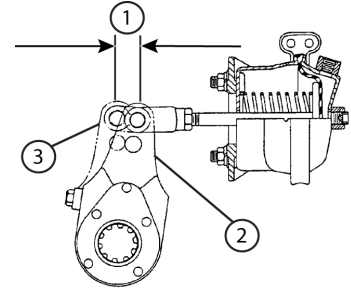

### Measuring Pushrod Travel

- 1 Short as Possible Without Brakes Dragging "Applied Stroke"
- 2 Released Position
- 3 Applied Position

**Periodically, brake adjustment should be checked using the following procedure:**

**⚠ WARNING!**

Automatic slack adjusters should not be manually adjusted to correct excessive pushrod travel/stroke. Excessive pushrod travel indicates a problem in either the automatic slack adjuster itself, the adjuster installation or with related foundation brake components. Improperly adjusting the slack adjuster(s) could reduce brake effectiveness and lead to an accident. Failure to comply may result in personal injury, death, equipment or property damage.

Correctly installed and functioning automatic slack adjusters will produce the pushrod travel for each chamber type listed in the following table.

**Table 12 Brake Adjuster Stroke**

80-90 PSI (552 - 621 KPA) BRAKE APPLICATION		
AIR CHAMBER TYPE (Size)	BRAKE	PUSHROD TRAVEL (Applied Stroke)
20-24	Front	1 to 1-3/4 in. (25-44mm)
16	Front	3/4 in. to 1-1/2 in. (19-38mm)
30	Rear	1-1/2 to 2 in. (38-51mm)

- If the pushrod travel exceeds the above specifications, have your Kenworth dealer inspect the slack adjuster and all other brake related components for excessive wear and/or damage. Replace components that are damaged or show signs of excessive wear.

**i NOTE**

The automatic brake adjuster alone does not ensure proper brake operation. Inspect all brake components. All brake components work together and must be checked periodically to ensure the brake system works properly.

# BRAKE SYSTEM MAINTENANCE

## Anti-Lock Braking System (ABS)

Below are some general notes on your Kenworth anti-lock braking system. All service work should be performed by a qualified technician at an authorized Kenworth Dealer. The foundation brake system must be in proper working order to ensure the best ABS performance.



### CAUTION

Before welding anywhere on the vehicle, detach the ABS Electronic Control Unit (ECU) connector and all other electronic control units. Failure to comply may result in equipment damage.



### CAUTION

Never detach the ECU connector with the ignition turned on. Failure to comply may result in equipment damage.



### NOTE

Check ABS wiring harnesses and piping periodically for chafing or other problems. No regular maintenance is required on the ABS components.



### NOTE

During wheel balancing, dyno testing, or any time the ignition is on with part of the ABS disconnected, a failure code will be recorded. Consult with your authorized Kenworth Dealer for information on clearing the failure code.

If, due to operating conditions, a brake application causes either wheel on the same axle to begin skidding, wheel speed sensors immediately signal the anti-lock controller in the modulator assembly. The controller responds instantly by signaling the solenoids in the modulator which activate the air valves, reducing application pressure as needed to prevent the wheels from locking up. If this over-riding correction is effective, application pressure is allowed to build up to the original input.

Any malfunction of the anti-lock system on one or more axles will cause the system to fail-safe, and the panel-mounted amber warning light will come on, indicating both a malfunction, and automatic shut-down of the system. If the air system is intact (indicated by the pressure gauges), the service brakes will continue to function normally, but without benefit of the anti-lock feature.





### NOTE

If one wheel on any driven axle continues to slip or spin for approximately 4 seconds, this will cause the anti-lock controller for that axle to go into the fail-safe mode, and the warning light will give a shutdown signal.

- In this case, the anti-lock system can be turned back on, and the warning light extinguished, by turning the key switch OFF and ON, after the vehicle has been brought to a full stop. When the key switch is turned back on, the warning light will illuminate and remain on for 3 to 5 seconds. This is a built-in function test of the warning light.



### WARNING!

Do not attempt to recycle the anti-lock system by turning the key switch OFF and ON until the vehicle has been brought to a full stop and the parking brakes set. Failure to do so could adversely affect steering and braking control, and may result in loss of vehicle control and an accident. Failure to comply may result in personal injury, death, equipment or property damage.



### WARNING!

Do not operate the vehicle in the event of a malfunction in any air circuit. Such a malfunction may prevent the brake system from operating properly, and could result in an injury accident. The vehicle should not be operated until the system is repaired and both braking circuits, including all pneumatic and mechanical components, are working properly. Failure to comply may result in personal injury, death, equipment or property damage.

### CAB MAINTENANCE

#### Exterior Maintenance Painted Surfaces

Wash painted surfaces frequently to remove grime and caustic deposits which may stain the finish. See Cleaning, Protecting, and Weather Stripping on page 5-57.

#### Chrome and Aluminum Surfaces

To prevent rust, keep chromed parts clean and protected with wax at all times, especially in winter conditions where the roads are salted.

- If necessary, use a commercial chrome cleaner to remove light rust.
- Chrome surfaces are best cleaned with fresh water. Wipe dry to preserve their luster. A commercial chrome cleaner will remove light rust. After cleaning, wax flat surfaces and apply a thin coat of rust preventive lubricant around bolts or other fasteners.
- Clean aluminum wheels and bumpers with warm water. Tar remover will get rid of heavy deposits of road grime. To prevent spotting, wipe aluminum surfaces dry after washing.

- Under corrosive conditions, such as driving on salted roads, clean aluminum parts with steam or high pressure water from a hose. A mild soap solution will help. Rinse thoroughly.

**Tail Pipe Surface Cleaning**

To maintain your quality finish, wash with a soft cloth, mild soap and water or glass cleaner. A non-abrasive chrome polish can be used sparingly on hard to clean areas. Do Not clean your high heat chrome using scouring pads, abrasive chrome polish, highly acidic chemical cleaners or any other abrasive cleaners.

	<b>CAUTION</b>
Using improper cleaning agents can harm your high heat chrome and invalidate your warranty.	

**Stainless Steel**

Even high quality stainless steel parts can rust under prolonged exposure to salt water, especially when the salt-laden moisture is held against the metal surface by road grime. It is, therefore, important to frequently clean salty moisture and grime from stainless steel surfaces.

- If surface rust is encountered, wash the surface and use a commercial polishing compound to clean off the rust, followed by a coating of wax (do not apply wax to hot parts, such as exhaust pipes).
- Never use steel wool when cleaning stainless steel because minute particles of the steel wool can embed in the surface of the stainless steel and cause rust staining.

**Cleaning, Protecting and Weather Stripping**

Frequent washings of the vehicle are required to remove grime and contaminants that can stain and oxidize paint and accelerate corrosion of plated and polished metal surfaces.

Waxing offers added protection against staining and oxidation. But to allow enough time for your truck's finish to cure, wait about 30 days after the date of manufacture before waxing. Do not apply wax in the hot sun and do not friction burn the paint with a buffing machine.

Occasionally spray weather-stripping on doors and windows with silicone compound to help preserve resiliency. This is especially useful in freezing weather to prevent doors and windows from sticking shut with ice.

# CAB MAINTENANCE

## Vehicle Cleaning

### Precautions

 <b>WARNING!</b>
Handle cleaning agents carefully. Cleaning agents may be poisonous. Keep them out of the reach of children.

- Observe all caution labels.
- Always read directions on the container before using any product.
- Do not use any solution that can damage the body paint.
- Most chemical cleaners are concentrates which require dilution.
- Only use spot removing fluids in well ventilated areas.

- Do not use gasoline, kerosene, naphtha, nail polish remover or other volatile cleaning fluids. They may be toxic, flammable or hazardous in other ways.
- Do not clean the underside of chassis, fenders wheel covers, etc. without protecting your hands and arms. You may cut yourself on sharp-edged metal parts.
- Moisture, ice, and road salt on brakes may affect braking efficiency. Test the brakes carefully after each vehicle wash.
- Any vehicle is subjected to deterioration from industrial fumes, ice, snow, corrosive road salt, etc., to name just a few causes. A well-cared-for vehicle can look like new many years later. Regular and correct care will contribute to maintaining the

beauty and the value of your vehicle.

Your Kenworth Dealer has a number of vehicle-care products and can advise you on which ones to use for cleaning the exterior and interior of your vehicle.

 <b>CAUTION</b>
Do not aim the water jet directly at door locks or latch. Tape the key holes to prevent water from seeping into the lock cylinders. Water in lock cylinders should be removed with compressed air. To prevent locks from freezing in the winter, squirt glycerin or lock deicer into the lock cylinders.

## Washing the Exterior

1. Begin by spraying water over the dry surface to remove all loose dirt before applying the car wash and wax solution.  
Do not wash the vehicle in direct sunshine.  
Do not spray water directly into the cab and sleeper vents.
2. Using soapy water, wash the vehicle with a clean soft cloth or a soft brush made for automotive cleaning.  
Use cool or warm water and a mild, household type soap. Strong industrial detergents and cleaning agents are not recommended.  
Do not use stiff brushes, paper towels, steel wool, or abrasive cleaning compounds because they will scratch painted, plated, and polished metal surfaces.
3. Rinse surfaces frequently while washing to flush away dirt that might scratch the finishes during the washing operation.
4. Wipe everything dry with a chamois to avoid water spots.  
To prevent water spotting, dry off the cosmetic surfaces with a clean cloth or chamois.
5. Remove road tar with an automotive type tar remover or mineral spirits.
6. After cleaning and drying, apply a quality automotive wax.
  - Do not apply wax in the hot sun.
  - Never dust off dry surfaces with a cloth because it will scratch the finishes.

	<b>NOTE</b>
To allow enough time for your truck's finish to cure, wait at least thirty days after the date of manufacture before waxing.	

# CAB MAINTENANCE

---

## Cleaning the Chassis

- Hose dirt and grime from the entire chassis. Then, if an oil leak develops, you will be able to detect it easier.
- Corrosive materials used for ice and snow removal and dust control can collect on the underbody. If these materials are not removed, accelerated corrosion (rust) can occur on underbody parts such as fuel lines, frames, floor pan, and exhaust system, even though they have been provided with corrosion protection.

At least every spring, flush these materials from the under body with plain water. Be sure to clean any area where mud and other debris can collect. Sediment packed in closed areas of the frame should be loosened before being flushed. If desired, your Kenworth Dealer can do this service for you.

## Cleaning Interior Vinyl and Upholstery

- Wipe vinyl upholstery and lining with a good commercial upholstery cleaner. Do not use acetone or lacquer thinner.
- Clean fabric upholstery with upholstery shampoo specially formulated for this purpose. Follow instructions on the container.

## Safety Restraint System - Inspection

The seat belt system, including webbing, buckles, latches, and mounting hardware, endures heavy use in heavy-duty vehicles, much more than seat belt systems in passenger cars. All users should be aware of the factors contributing to this heavy use and reduced belt life.



### **WARNING!**

Failure to properly inspect and maintain restraint systems can lead to injury or loss of life. Without periodic inspection and maintenance to detect unsafe conditions, seat restraint components can wear out or not protect you in an accident.

### Factors contributing to reduced seat belt life:

- High mileage heavy trucks, often accumulate mileage in excess of 500,000 total miles (800,000 km) during the vehicle lifetime. This is much greater than a typical passenger car, which frequently will not exceed 125,000 total miles (200,000 km).
- Seat and cab movement in trucks, there is almost constant movement of the belt due to ride characteristics and seat design. The constant movement of the belt inside the restraint hardware and the potential for the belt to come in contact with the cab and other vehicle parts, contributes to the wear of the entire system.

- Environmental conditions, such as dirt and ultraviolet rays from the sun, will reduce the life of the seat belt system.

Due to these factors, the three-point safety belt system installed in your vehicle requires thorough inspection every 20,000 miles (32,000 km). If the vehicle is exposed to severe environmental or working conditions, more frequent inspections may be necessary.

Any seat belt system that shows cuts, fraying, extreme or unusual wear, significant discoloration due to UV (ultraviolet) exposure, abrasion to the seat belt webbing, or damage to the buckle, latch plate, retractor hardware or any other obvious problem should be replaced immediately, regardless of mileage.



### WARNING!

It is important to remember that any time a vehicle is involved in an accident, the entire seat belt system must be replaced. Unexposed damage caused by the stress of an accident could prevent the system from functioning properly the next time it is needed. Failure to comply may result in personal injury or death.

# CAB MAINTENANCE

## Inspection Guidelines

Follow these guidelines when inspecting for cuts, fraying, extreme or unusual wear of the webbing, and damage to the buckle, retractor, hardware, or other factors. Damage to these areas indicates that belt system replacement is necessary.



### WARNING!

Replace the entire belt system (retractor and buckle side) if replacement of any one part is necessary. Unexposed damage to one or more components could prevent the system from functioning properly the next time it is needed. Failure to comply may result in personal injury or death.

5

1. Check the web wear in the system. The webbing must be closely examined to determine if it is coming into contact with any sharp or rough surfaces on the seat or

other parts of the cab interior. These areas are typical places where the web will experience cutting or abrasion. Cuts, fraying, or excessive wear would indicate the need for replacement of the seat belt system.

2. The pillar web guide (D-loop) is the area where almost constant movement of the seat belt webbing occurs because of relative movement between the seat and cab.
3. Check the Comfort Clip for cracks or possible damage and check for proper operation.
4. Check buckle and latch for proper operation and to determine if latch plate is worn, deformed, or damaged.
5. Inspect the retractor web storage device, which is mounted on the floor of the vehicle, for damage. The retractor is the heart of the

occupant restraint system and can often be damaged if abused, even unintentionally. Check operation to ensure that it is not locked up and that it spools out and retracts webbing properly.

6. If tethers are used, be sure they are properly attached to the seat and, if adjustable, that they are adjusted in accordance with installation instructions. Tethers must also be inspected for web wear and proper tightness of mounting hardware.
7. Mounting hardware should be evaluated for corrosion, and for tightness of bolts and nuts.
8. Check web in areas exposed to ultraviolet rays from the sun. If the color of the web in these areas is gray to light brown, the physical strength of the web may have deteriorated due to exposure to



the sun's ultraviolet rays. Replace the system.

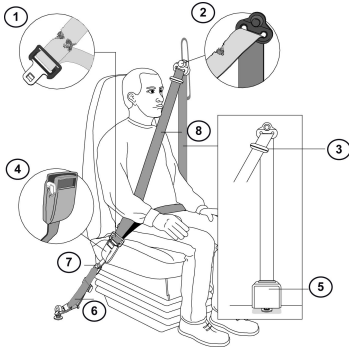

### Seat Belt Inspection Points

- 1 Web cut or frayed or extremely worn at latch area.
- 2 Web cut or frayed at D-loop web guide.
- 3 Comfort Clip cracked or damaged.
- 4 Buckle casting broken.

- 5 Retractor Web Storage for damage. (located behind trim panel)
- 6 Tethers for web wear and proper tightness of mounting hardware.
- 7 Mounting hardware for corrosion, proper tightness of bolts and nuts.
- 8 Web for deterioration, due to exposure to the sun

 <b>WARNING!</b>
<p>Failure to adjust tether belts properly can cause excessive movement of the seat in an accident. Tether belts should be adjusted so that they are taut when the seat is in its most upward and forward position. Failure to comply may result in personal injury or death.</p>

Once the need for replacement of the seat belt has been determined, be certain it is only replaced with an authorized PACCAR Parts replacement seat belt.

If the inspection indicates that any part of the seat belt system requires replacement, the entire system must be replaced. An installation guide is attached to every replacement belt. Utilize the proper guide for your type of seat, and follow the instructions very closely. It is vitally important that all components be reinstalled in the same position as the original components that were removed and that the fasteners be torqued to specification. This will maintain the design integrity of the mounting points for the seat belt assembly. Contact your Authorized Kenworth Dealer if you have any questions concerning seat belt replacement.

## CAB MAINTENANCE

---

### Windshield Wiper/Washer

The windshield wiper system is maintenance free. Check wiper blades annually or every 60,000 miles (96,000 km). Anco wiper blades are recommended. See Windshield Wipers/Washer on page 3-105, for more information.

### Washer Reservoir

	CAUTION
Do not use antifreeze or engine coolant in the windshield washer reservoir, damage to seals and other components will result.	

**Daily:** Check reservoir water level, located in the engine compartment. If necessary, refill to the proper level.

### COOLING SYSTEM MAINTENANCE



#### WARNING!

Do not remove the radiator cap on a hot engine. It can cause scalding coolant to spray out and you could be burned. If the engine has been operated within the last 30 minutes, be very careful in removing the radiator cap. Failure to comply may result in personal injury, death, equipment or property damage.



#### WARNING!

Do not work on the fan with the engine running. The engine fan can engage at any time without warning. Anyone near the fan when it turns on could be injured. Before turning on the ignition be sure that no one is near the fan. Failure to comply may result in personal injury, death, equipment or property damage.

Kenworth Trucks are standard with Air-to-Air cooling systems. These cooling systems incorporate a radiator to cool engine jacket water, a Charge Air Cooler to cool turbo-charged engine intake air, and a refrigerant condenser to provide cab air conditioning.

### Topping Up

Check the coolant level after each trip when the engine has cooled. The coolant level should be visible within the sight gauge (glass level indicator) on the surge tank. Add coolant as necessary (see Adding Coolant on page 5-67).

With the engine cold, top up with premixed coolant. Add the coolant through the pressure cap neck on the surge tank. The surge tank is located on the firewall, right side.

With the engine cold, the coolant level should be at the full cold coolant level. Use caution not to overfill the system with coolant. An overfilled cooling system will cause loss of coolant through the radiator cap as the coolant expands during heating. Replacement or makeup coolant should have the same antifreeze concentration and corrosion inhibitor content as

## COOLING SYSTEM MAINTENANCE

the original coolant in the cooling system. Never add 100% antifreeze to the cooling system. Always dilute anti-freeze to the correct concentration based on freeze protection prior to adding it to the cooling system. Adding or using 100% antifreeze in a cooling system may result in cooling system plugging and overheating problems.



### NOTE

If frequent topping up is necessary and there are not visible signs of coolant leaks when the engine is cold, check for leaks with the engine operating at normal operating temperature.



### WARNING!

Do not remove the radiator cap on a hot engine. It can cause scalding coolant to spray out and you could be burned. If the engine has been operated within the last 30 minutes, be very careful in removing the radiator cap.

- **Protect face, hands, and arms against escaping fluid and steam by covering the cap with a large, thick rag.**
- Carefully and slowly turn cap (on expansion surge tank) one quarter of a turn to allow excess pressure to escape before completely removing cap. If you see any steam or coolant escaping, do not even try to remove it until the radiator cools down.

If you see nothing escaping, still remove the cap very slowly and carefully. Be ready to back off if any steam or coolant begins to escape.



### WARNING!

Handle coolant and antifreeze carefully. Ethylene glycol antifreeze is poisonous. Store in original fluid container only, and always keep out of reach of children. Failure to comply may result in personal injury, death, equipment or property damage.



### WARNING!

Never remove the cap on the surge tank while the engine is still hot. Wait until the coolant temperature is below 120° F (50° C). Scalding steam and fluid under pressure may escape and cause personal injuries.



### WARNING!

Do not work on the fan with the engine running. The engine fan can engage at any time without warning. Anyone near the fan when it turns on could be injured. Before turning on the ignition, be sure that no one is near the fan.

### Adding Coolant

A mixture of water and low silicate antifreeze should be used for coolant. Water must be clean and free of corrosive and scale-forming chemicals. Drinking water may not be good for your vehicle. New vehicles come premixed with antifreeze and corrosion inhibitor. Be sure different types of coolant are not mixed. Stay with the same coolant until a complete Replacement is performed.

### Coolant Conditioner

A variety of test methods are available for measuring coolant conditioner levels. Test strips provide convenient and consistent results with minimal training. Other test methods can be used when appropriate training is provided. The actual test (i.e. test strips, etc.) and coolant conditioner maintenance schedule should be done in accordance with the actual coolant conditioner manufacturer recommendations.

The coolant conditioner should be recharged according to Table 6, Recommended Lubrication Intervals on page 5-11, unless otherwise specified in the Engine Manufacturers Maintenance Manual.

# COOLING SYSTEM MAINTENANCE

## Additives

If you add supplemental coolant additives to the radiator, maintain them at the recommended levels. Read the label carefully. Too much additive could harm your vehicle.

Approved additives help neutralize the water's harmful effects on your vehicle's cooling system. Ask your dealer to recommend the best ones for you.

- Do not add rust inhibitors, radiator sealants, or water pump lubricants containing soluble oil to the coolant. These additives can cause the anti-corrosion chemicals not to work.
- If the cooling system in your truck has a treated spin-on water filter, install the service filter on all B or E scheduled service intervals. See Table 9, Maintenance Schedule on page 5-16.

For more detailed recommendations check with your Kenworth Dealer or check the manufacturer's Engine Operation and Maintenance Manual.

- Antifreeze solutions containing anti-leak additives will quickly restrict the water filter. If this happens, the filter will not work. So stay away from anti-leak additives.

 CAUTION	
Do not add inhibitor if the engine has a Dry Charge Additive (DCA4) water filter cartridge containing corrosion inhibitor, engine damage from over concentration of silicates may occur.	

- The water filter cartridge containing DCA4 inhibitor must be periodically changed. Refer to the Engine Operation and Maintenance Manual for details.

 CAUTION	
Do not mix inhibitor types. Improper mixing of coolant may damage the engine.	

- For coolant conditioner recharge intervals see the Engine Operation and Maintenance Manual.

## Change and Refilling

The coolant must be changed periodically. When draining coolant, capture old coolant and dispose of it properly.

## Refilling

**To refill the cooling system, follow the recommendations below:**

1. Before refilling be sure the radiator and engine block drains are closed.
2. Move the heater control to maximum heat position.
3. Remove the surge tank pressure cap.
4. Through the surge tank, fill the system with premixed coolant. Pour it in a steady flow until the radiator is full.
5. Start the engine and idle it at low RPM.
6. Complete the filling as quickly as possible. Idle the engine until it reaches normal operating temperature.

7. Fill the radiator as necessary to raise the coolant level to the proper level.
8. Replace the surge tank pressure cap.

You may find the coolant level is not up to the correct level soon after you have filled the radiator. This may be because all the trapped air in the system has not yet been purged. It takes a little time for all the air to leave the system after you fill the radiator.

For further details on coolant, coolant capacities, water filters, and antifreeze mixture see the Engine Operation and Maintenance Manual (supplied with the vehicle).

## COOLING SYSTEM MAINTENANCE

---

### Radiator Cap

 CAUTION
When replacing the radiator cap always use one with the correct rated pressure. Failure to do so could cause engine or cooling system damage.

All radiator caps are marked with the rated pressure (psi) of the cap.

### Engine (Block) Heater

Regularly inspect the engine block heater wiring and connector for damaged or frayed wires. Contact your authorized Kenworth Dealer or the manufacturer of the heater if you are in need of repairs or information.

 <b>WARNING!</b>
Do not use the heater if there are any signs of problems. Engine block heaters can cause fires resulting in personal injury, death, equipment or property damage if not properly maintained and operated.

 CAUTION
Always unplug the block heater before starting your engine. Damage to the cooling system could occur if not turned OFF (unplugged).

Use a solution of half ethylene glycol antifreeze and half water for best

heater performance. Do not use more than 65 percent concentration of antifreeze, as a shortened heater life will result.

After servicing the cooling system, operate the vehicle for a day or two before using the heater. Trapped air inside the engine needs time to escape.



## ELECTRICAL MAINTENANCE

### Electrical System



#### WARNING!

Battery posts, terminals and related accessories contain lead and lead compounds, chemicals known to the State of California to cause cancer and reproductive harm. Wash hands after handling.



#### CAUTION

Do not modify or improperly repair the vehicles electrical system or power distribution box. All electrical repairs should be performed by an authorized Kenworth dealer. Improper repair or modifications will void your warranty and/or cause serious damage to your vehicle.

### Fuses, Circuit Breakers, and Relays

Fuses, circuit breakers, and relays are located in the Power Distribution Box to the left of the steering column behind the clutch pedal. See Power Distribution Box on page 5-73. Additional fuses for the alternator, engine electronics and trailer battery charge circuit may be located in the Power Distribution Center (PDC) inside the battery box and/ or on the engine side of the cab firewall.

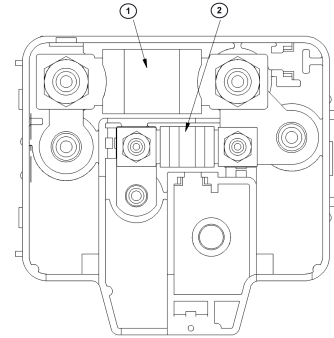

Power Distribution Center (shown without fuse cover)

1. MEGA FUSE
2. MIDI FUSE

## Fuse Inspection and Replacement



### WARNING!

Do not replace a fuse with a fuse of a higher rating. Doing so may damage the electrical system and cause a fire. Failure to comply may result in personal injury, death, equipment or property damage.



### CAUTION

Before replacing a fuse, turn OFF all lights and accessories and remove the ignition key to avoid damaging the electrical system.



### CAUTION

Never patch fuses with tin foil or wire. This may cause serious damage elsewhere in the electrical circuit, and it may cause a fire.



### CAUTION

If a circuit keeps blowing fuses, have the electrical system inspected for a short circuit or overload by an authorized Kenworth dealer as soon as possible. Failure to do so could cause serious damage to the electrical system and/or vehicle.



### NOTE

If a fuse of the same rating is not available, a fuse of a lower rating may be temporarily substituted. You can also use a fuse from a circuit you can do temporarily without (for example an accessory circuit or radio).

See the Kenworth Shop Manual for instructions on fuse replacement.

All the electrical circuits have fuses to protect them from a short circuit or overload. If something electrical on your chassis stops working, the first

thing you should check for is a blown fuse.

1. Turn OFF all lights and accessories and remove the ignition key to avoid damaging the electrical system.
2. Determine from the chart on the fuse panel which fuse controls that component.
3. Remove that fuse and see if it is blown.

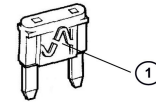



If a fuse is blown, replace it with a fuse of the same rating.

- 1 Blown

## Adding Electrical Options

 <b>WARNING!</b>
Do not add a fuse with a rating higher than 30 amps. Follow the circuit protection size/type recommended by the component manufacturer. Installing a fuse or circuit breaker greater than designated may damage the electrical system which could lead to equipment damage and/or personal injury.

 <b>CAUTION</b>
Follow all manufacturers' circuit protection recommendations for the components and wires being added. Failure to comply may result in equipment damage.

 <b>NOTE</b>
If you are unfamiliar with proper electrical repair practices and procedures, see your authorized Kenworth dealer for assistance.

 <b>NOTE</b>
Easy addition of circuits is provided by plug-in connectors that have a ground and a power wire.

For proper electrical system performance, refer to a wiring diagram for your chassis before adding electrical options.

 <b>WARNING!</b>
Never install a circuit breaker in a circuit that is designated as "fuse-only" circuit(s). Fuse-only circuits are marked with an * on the reverse side of the Power Distribution Box cover. Using a circuit breaker in those fuse-only circuits may cause the circuit to overheat when a short exists which could lead to equipment damage and/or personal injury.

## ELECTRICAL MAINTENANCE



### NOTE

Do not install a circuit breaker in place of a fuse for the following circuits:

- ACC FEED
- BODY IGN
- CAB ABS - BATT
- CAB ABS - IGN
- CAB ACC
- CB PWR
- CECU - BATT (2 PLCS)
- CECU IGN
- DOOR IGN
- ENG AUX
- ENG SD
- FOG LMPS
- GAUGE CL
- HIGH BEAM SUP
- LH DR / DOOR LOCK
- LOW BEAM SUP
- PARK LMP SNSE
- RADIO MEM
- RADIO PWR
- RH DOOR
- RKE
- TRLR ABS
- TURN MOD PWR



Power Distribution Box: Typical - See reverse side of Power Distribution Box cover for fuse and relay locations

1. Clutch Pedal

	1	2	3	4	5	6	7	8	9	10	11	12
SP												
A	SPACE BATT A	SPACE BATT B	SPACE BATT C	SPACE BATT D	SPACE BATT E	SPACE BATT F	SPACE BATT G	SPACE BATT H	SPACE BATT ACC	SPACE BATT ACC	SPACE BATT ACC	SPACE BATT ACC
B	SPACE SW A	SPACE SW B	SPACE SW C	SPACE SW D	SPACE SW A	SPACE SW B	SPACE SW A	SPACE SW B	SPACE SW A	SPACE SW B	SPACE SW A	SPACE SW B
C	MISC ACC	KEY FLOOD	NOT SW	HOT LINES	CAB USED	IGN MKR	SIGN LMP	SPOT LMP	WIPR LMP	PARK LMP	RH LMP	DOOR LMP
D	PARK LAMP	TRLR LAMP	RADIO STOP	MEM LAMP	STOP SIG	CCCU STOP	TRLR INTR	RXC INTR	DR L/P	MIRR CAB	HEAT ASS	
E	PARK LAMP RELAY	IGN BUS RELAY	IGN BUS RELAY	MARKER FLASH RELAY	WIPER RELAY	TRAILER STOP RELAY	TRAILER STOP RELAY	TRAILER STOP RELAY	TRAILER STOP RELAY	TRAILER STOP RELAY	TRAILER STOP RELAY	TRAILER STOP RELAY
F	ENG DOOR	AC RELAY	WARM FEED	AIR LMP	ENG TANK	CCCU TANK	AUX TANK	15A	15A	15A	15A	15A
G	IDLE TIMER	ACC BUS RELAY	CAB MKR	LP RELAY	WIPER ON RELAY	SLEEPER HYVAC RELAY	TRAILER MKR	LP RELAY	TRAILER MKR	LP RELAY	TRAILER MKR	LP RELAY
H	CAB DOME LPS	SLPR ACC	SLPR ACC	SLPR ACC	SLPR ACC	SLPR ACC	SLPR ACC	SLPR ACC	SLPR ACC	SLPR ACC	SLPR ACC	SLPR ACC
J	AC CMP CLUTCH RELAY	FLOOD LAMP RELAY	HORN LAMP RELAY	REFER INTFT	START INTFT	SPARE RELAY #1	SPARE RELAY #2	SPARE RELAY #2	SPARE RELAY #2	SPARE RELAY #2	SPARE RELAY #2	SPARE RELAY #2

THIS SECTION OF CENTRAL PANEL BEHIND INSTRUMENT PANEL.



REFER TO MANUAL OR CONTACT AN AUTHORIZED SERVICE PERSON TO SERVICING.

THE CIRCUITS MARKED WITH (\*) MUST BE PROTECTED BY FUSE ONLY. NO CIRCUIT BREAKER, FUSE, OR INSTRUMENT OR DETAIL.

ADDITIONAL FUSES FOR ENGINE LOCATED IN BATTERY BOX COMPARTMENT.

SPARE FUSE MAX RATING 30 AMP.

70 AMP RELAYS IN BATTERY BOX ACCESSORY BUS



PS-1190

**Power Distribution Box**  
(2010 T6 - T8 - T4)

# ELECTRICAL MAINTENANCE

5

	1	2	3	4	5	6	7	8	9	10	11	12
SP												
A	SPARE BATT A	SPARE BATT B	SPARE BATT C	SPARE BATT D	SPARE BATT E	SPARE BATT F	SPARE BATT G	SPARE BATT H	SPARE BATT A	SPARE ACC B	SPARE ACC C	SPARE ACC D
B	SW A	SW B	SW C	SW D	SW A	SW B	SW A	IGN B	IGN C	IGN D	IGN	IGN
C	MISC CURR SW	KEY FLOOD	NOT USED	NOT USED	HOT CAB	IGN	SPOT W/PR	PARK LAMPS	W/PR LAMPS	TRAILER LAMPS	TRAILER LAMPS	TRAILER LAMPS
D	PARK LAMP SW	STOP LAMP SW	STOP LAMP SW	STOP LAMP SW	STOP LAMP SW	STOP LAMP SW	STOP LAMP SW	STOP LAMP SW	STOP LAMP SW	STOP LAMP SW	STOP LAMP SW	STOP LAMP SW
E	PARK LAMP RELAY	IGN BUS RELAY	IGN BUS RELAY	IGN BUS RELAY	IGN BUS RELAY	IGN BUS RELAY	IGN BUS RELAY	IGN BUS RELAY	IGN BUS RELAY	IGN BUS RELAY	IGN BUS RELAY	IGN BUS RELAY
F	ENG DOOR SW	ACC RELAY	FEED RELAY	FEED RELAY	FEED RELAY	FEED RELAY	FEED RELAY	FEED RELAY	FEED RELAY	FEED RELAY	FEED RELAY	FEED RELAY
G	IDLE TIMER RELAY	ACC BUS RELAY	ACC BUS RELAY	ACC BUS RELAY	ACC BUS RELAY	ACC BUS RELAY	ACC BUS RELAY	ACC BUS RELAY	ACC BUS RELAY	ACC BUS RELAY	ACC BUS RELAY	ACC BUS RELAY
H	CAB LPS ACC	SLPR ACC	SLPR ACC	SLPR ACC	SLPR ACC	SLPR ACC	SLPR ACC	SLPR ACC	SLPR ACC	SLPR ACC	SLPR ACC	SLPR ACC
J	AC CHP RELAY	FLOOD RELAY	HORN RELAY	REPER RELAY	START RELAY	START RELAY	START RELAY	START RELAY	START RELAY	START RELAY	START RELAY	START RELAY

THIS SECTION OF CENTRAL PANEL BEHIND INSTRUMENT PANEL.



**WARNING!**  
REFER TO OPERATOR MANUAL FOR CONTACT AN AUTHORIZED KW DEALER, SERVICING

THE CIRCUITS WITH (W) MUST BE PROTECTED WITH FUSE NO CIRCUIT BREAKERS. SEE OPERATOR MANUAL FOR DETAILS.

ADDITIONAL ELECTRONIC ENGINE LOCATED IN BATTERY BOX OR ENGINE COMPARTMENT SPARE FUSE MAX RATING 30 AMP.

70 AMP RELAYS ACCESSORY BUS



PGS-1209 REV. A

**Power Distribution Box**  
(2013 T440 - 470)

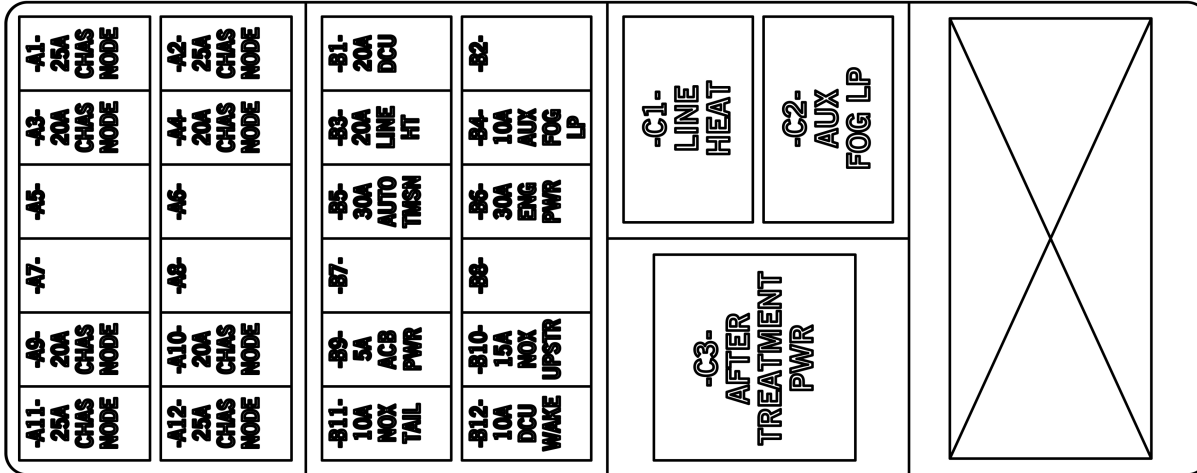

Chassis Load Center Fuse Box (Cummins)

## Batteries

### Battery Access

The vehicle is originally equipped with three or four batteries. Replacement batteries must meet the following specifications: maintenance-free, group 31 size, threaded stud, 12V/ 650 cold cranking ampere (CCA), and 160 minutes of reserve capacity.

The battery compartment is located on the left side of the vehicle, under the cab access steps.

1. Remove steps by removing 2 bolts from each step.
2. Remove 4 bolts and washers from forward fairing.
3. Remove 2 bolts (A) from step strut.
4. Remove battery cover for access.

### In-Cab Battery Box

Your vehicle may be equipped with Optima brand Absorbed Glass Mat (AGM) batteries located in the cab under the passenger's seat. The glass mat in AGM batteries is designed to absorb the battery acid inside the battery that can leak or spill out in conventional batteries. This design feature allows Optima batteries to be positioned in any orientation without risk of leaking.

To access the batteries:

1. Remove 6 fasteners securing the passenger side seat base to the battery box assembly.
2. Remove the seat and seat base as one unit to gain access to the batteries.



### WARNING!

Batteries release gases that are flammable. Batteries are equipped with vent tubes and flash arrestors which vent battery gases out of the cab. Ensure all vent tubes, flash arrestors and grommets are properly installed and ensure they are clear and functioning properly. Failure to reinstall or keep the vent tubes and grommets clear or ensure the flash arrestor(s) are functioning properly could result in personal injury or equipment damage. Failure to comply may result in personal injury, death, equipment or property damage.





### WARNING!

Replace only with Optima brand AGM (Group 31) batteries. Use of other batteries could result in acid leaks causing personal injury in the event of a vehicle accident. Failure to comply may result in personal injury, death, equipment or property damage.



### WARNING!

Battery cables and air/electrical harnesses are mounted to the bottom of the floor. Do not drill or screw into floor pan without first checking the location of the cables, harnesses or any other component that might be damaged. Damaging any component could result in electrical shock which could cause personal injury and/or loss of a critical truck system. Failure to comply may result in personal injury, death, equipment or property damage.



### WARNING!

Electrical damage or battery explosion can occur when improperly charging batteries. Refer to the operation and service manual for appropriate charging instructions. Failure to comply may result in personal injury, death, equipment or property damage.



### CAUTION

Do not store other items in this battery box. Failure to comply could result in damage to the truck and/or batteries.



### CAUTION

Properly secure battery tie downs and battery box cover when reinstalling batteries after service. Do not over tighten. Over tightening can crack the battery case which can lead to equipment damage.

### Replacing Parts Removed for Access

1. Replace battery cover.
2. Install 2 bolts in step strut. Torque to 24-32 lb-ft (33-43 Nm).
3. Install fairing and install 4 bolts. Torque to 6-7 lb-ft (8-9 Nm).
4. Install steps by installing 2 bolts in each step. Torque to 24-32 lb-ft (33-43 Nm).



### WARNING!

Always reinstall the steps before entering the cab. Without the steps you could slip and fall, resulting in possible injury to yourself.

# ELECTRICAL MAINTENANCE



## WARNING!

Fairings not installed properly could come loose and cause other motorists to have an injury accident. It is important that fairings be installed properly. Failure to comply may result in personal injury, death, equipment or property damage.



## WARNING!

Before attempting any work on the batteries or electrical system, remove all jewelry. If metal jewelry or other metal comes in contact with electrical circuits, a short circuit may occur causing you to be injured, as well as electrical system failure and damage.

## Removing and Installing Batteries:

1. Be sure all switches on the vehicle are turned OFF.
2. Disconnect negative ground cable first.
3. Disconnect positive cable.
4. Unscrew bolt of holding plate with open end wrench.



## NOTE

Always dispose of automotive batteries in a safe and responsible manner. Contact your authorized Kenworth dealer for disposal standards. Call your local authorized recycling center for information on recycling automotive batteries.



## NOTE

Make sure to reconnect the ground (negative) cable last.

1. Place batteries in vehicle and tighten bolt of holding plate.
2. Reconnect positive cable.
3. Reconnect ground (negative) ground cable.



## CAUTION

Battery replacement may alter or disturb battery cable routing. Check to insure battery cables are free from any point of chaffing. Failure to do so could result in personnel injury or property damage.

Follow the procedure below to reinstall batteries on the vehicle:

## Battery Care

Regular attention to the charging system will help prolong the service life of the batteries. Here are some common causes of battery failure:

**Overcharge:** this condition results from improper voltage regulator adjustment. It results in overheating of the battery, warped plates, and evaporation of electrolyte.

**Undercharge:** the voltage regulator is malfunctioning, the drive belt is slipping, or your vehicle has undergone long periods of standing idle or short distance driving. These conditions result in battery plates becoming covered with a hard coating.

**Vibration:** loose battery hold-downs may cause battery plate failure.

**Short Circuits:** these discharge the battery by draining electricity.

### Dirty or Loose Connections:

improper connections may stop the flow of electrical power to and from the battery.

## Battery Charging

Except for using small trickle charges to maintain battery condition, you should have your vehicle's batteries charged by a qualified service facility.



### WARNING!

Batteries can injure you severely. They contain acid, produce poisonous and explosive gases, and supply levels of electric current high enough to cause burns. A spark or flame near a battery on charge may cause it to explode with great force. Never remove or tamper with the battery caps. Failure to comply may result in personal injury, death, equipment or property damage.

**To help reduce the risk of personal injuries, follow these guidelines carefully when recharging a battery:**

- Before attempting any service in the electrical installation,

# ELECTRICAL MAINTENANCE

---

5

disconnect the battery negative cable.

- Allow no sparks or open flame anywhere near the charging area.
- Charge a battery only in a well-ventilated area, such as outdoors or in a fully open garage which contains no pilot lights or other flames. Gases generated during the charging process must be allowed to escape.
- Always make sure the battery charger is OFF before connecting or disconnecting the cable clamps.
- To avoid short circuits, damage to the vehicle, or personal injury, never place metal tools or jumper cables on the battery or nearby. Metal that accidentally comes in contact with the positive battery terminal or any other metal on the vehicle (that is in contact with the

positive terminal), could cause a short circuit or an explosion.

## Charging Reminders

- Use protective eyewear.
- Keep all batteries away from children.
- Never reverse battery poles.
- Never attempt to place the vehicle in motion, or run the engine with batteries disconnected.
- Keep the battery clean and dry.
- Look for any signs of damage.
- Battery terminals should not be coated with improper grease. Use petroleum jelly or commercially available, noncorrosive, nonconductive terminal coatings.
- Never use a fast charger as a booster to start the engine. This can seriously damage sensitive electronic components such

as relays, radio, etc., as well as the battery charger. Fast charging a battery is dangerous and should only be attempted by a competent mechanic with the proper equipment.

## Slow Battery Charging

	NOTE
Follow the instructions that come with your battery charger.	

- It is not necessary to remove the battery from the compartment.

	<b>WARNING!</b>
Charger cables must be connected positive to positive (+ to +) and negative to negative (- to -). If connected improperly, batteries could explode. Failure to comply may result in personal injury, death, equipment or property damage.	

- **Always make sure the battery charger is OFF before connecting or disconnecting the cable clamps. To reduce the danger of explosions and resulting personal injury, do not connect or disconnect charger**

**cables while the charger is operating.**

1. Disconnect the battery cables.
2. Connect charger cables.
3. Start charging the battery at a rate not over 6 amperes. Normally, a battery should be charged at no more than 10 percent of its rated capacity.
4. After charging, turn OFF charger and disconnect charger cables.

## Electrical and Alternator Precautions

### Take the following precautions to avoid burning out alternator diodes:

- Do not start the engine with alternator disconnected (connections removed) from the circuit.
  - Before welding, disconnect all electronic connections to the vehicle batteries.
  - Remove battery power cable and insulate it from the vehicle.
  - Do not run the engine with the batteries disconnected.
  - Do not disconnect the battery cables or alternator connection cables with the engine running.
  - Never turn the ignition switch from the ON position to the START position with the engine running.
- When charging the battery (installed in the vehicle) disconnect the battery cables.
  - Do not reverse the cables of the alternator, starter motor, or battery.
  - Do not polarize the alternator. The alternator should not be polarized like a generator. To ensure correct polarity, use a test lamp or a voltmeter.

## Remote Keyless Entry Troubleshooting

The remote keyless entry system may become non-operational due to failure of a key fob battery. If you have issues with a key fob, replace the battery and re-synchronize the key fob. In some situations, the key fob may need to be replaced and in others, a fuse may have failed and may render both key fobs inoperative.

See battery replacement instructions on page 1-13.

See synchronization instructions on page 1-13.

Contact your dealer for more help, if a key fob does not work and it is not because of a bad battery.

## Halogen/HID Lamp Headlamp Servicing

A Halogen or HID (High Intensity Discharge) Projector headlamp assembly comprises of a Halogen or HID projector low beam, a complex reflector high beam, two side marker/turn signal lamps, housing and mounting/wiring hardware.

<b>i</b>	<b>NOTE</b>
It is normal for some fogging on the inside of the lens to occur. This condensation may be removed by driving the vehicle for an extended period with the headlights turned on. Servicing is required if water droplets or puddles of water form on the inside of the headlamp.	

### Servicing

Access is gained from the rear of the assembly.

### Rear of Halogen/HID Housing

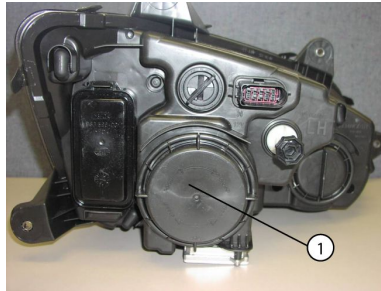

1 Low-beam Access Cover

Follow the procedure below to replace HID bulbs.

### Removing Ignition Device

1. Rotate low-beam access cover counter-clockwise and remove cover.

### Low-Beam Access Cover

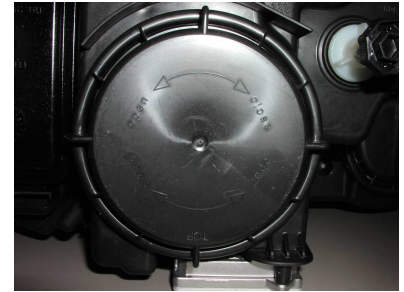

2. Rotate Ignition Device 25° counter-clockwise.
  - ° High-voltage line will be automatically ejected as a safety precaution.

# ELECTRICAL MAINTENANCE

## Ignition Device



- 1 High-voltage cable ejected
- 2 Ignition Device

## Projector Housing Spring Clips

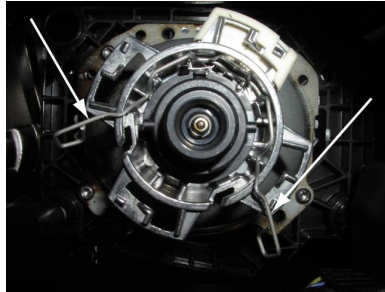

2. Release spring ends and let hang free.

 <b>CAUTION</b>
The spring clip cannot be displaced "upwards." The arms of the spring can be moved only so far apart to remove the bulb. Discharge bulbs are filled with overpressure. The glass bulb may burst if improperly handled.

3. Carefully remove the bulb.

## Cleaning or Disposal

 <b>NOTE</b>
Do not touch glass bulb with bare fingers. Oil from your skin can damage the life of the bulb. If touched, the glass can be cleaned with de-natured alcohol and wiped clean with a lint-free cloth. Discharge bulbs may be filled with a trace amount of mercury. The bulb will be marked with a Symbol indicating Mercury (Hg). Follow Hazardous Waste regulations for disposal.

5

3. Pull Ignition Device away from bulb.

## Remove HID Bulb

1. Squeeze the two projector housing spring ends marked with arrows towards each other and then deflect away from bulb housing.



## Bulb

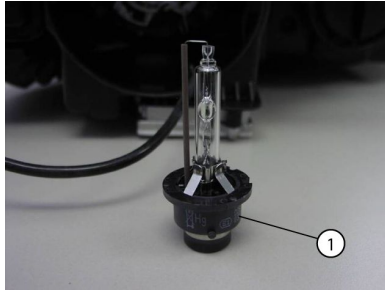

- 1 Symbol Indicating Mercury (Hg)

## Bulb Installation

1. During installation of the bulb the wire with the ceramic insulation should be pointed down.

## Bulb Details

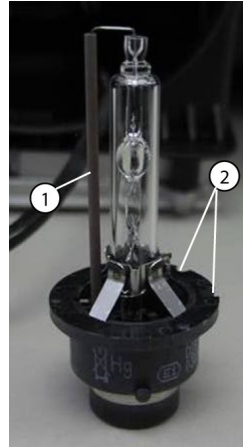

- 1 Ceramic Insulated Wire
  - 2 Indexing Grooves
2. Install bulb into the projector housing.

i	NOTE
There are two indexing grooves (12 o'clock and 2 o'clock) located on the largest diameter of the bulb. These index the bulb only one way in the projector housing.	

3. Squeeze the two projector housing spring ends towards each other and then make sure they engage in the grooves.

# ELECTRICAL MAINTENANCE

## Projector Housing Installation

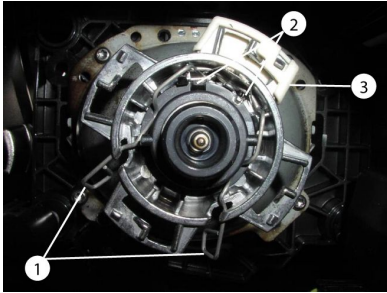

- 1 Spring Grooves
- 2 Index Points (12 o'clock and 2 o'clock)
- 3 White Tab

1. Verify white ring alignment. If needed, carefully rotate ring with a small blunt tool, so that the 4 grooves in the housing and ring are aligned or the device cannot be installed.
2. This tab indexes with white tab on projector housing (see following Fig.).

## Ignition Device

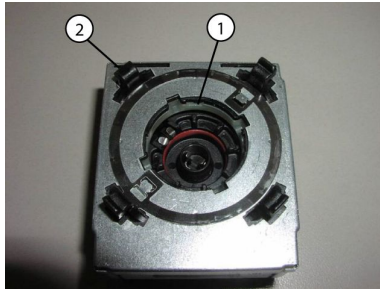

- 1 White Ring Tab
- 2 White Ring

3. Push Ignition Device onto back of projector housing.
4. Rotate Ignition Device 25° clockwise until it locks into place.
5. Lastly, install the high-voltage cable to the ignition device.

## Ignition Device Installed

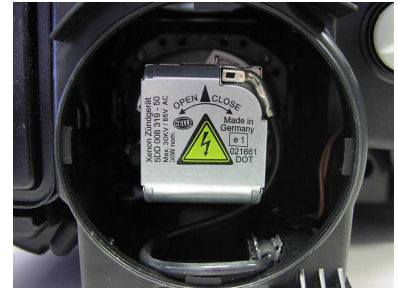

## Close Cover

1. Install and rotate low-beam access cover clockwise.

5

## Ignition Device Installation



### CAUTION

Care must be taken to **NOT** install the High-voltage cable until after the Ignition device is fully installed, otherwise, damage may result to either the Ignition Device or the HID Bulb.

### Close Low-Beam Access Cover



3. Keep your headlamps clean. A dirty headlamp reduces headlamp performance and creates glare.
  - Use only clean soap and water.
  - Your headlamp is coated with a special substance to resist chips and hazing. Harsh chemicals and polishing can remove this coating.

### Final Checks

1. After everything is reconnected, turn on your headlamps and check for operation.
2. Have your headlamps periodically checked for proper alignment. Headlamps should be adjusted to  $-0.6^{\circ}$  ( $-1.0\%$ ) Vertical.

## ENGINE MAINTENANCE

### Engine Maintenance



#### WARNING!

Exhaust fumes from the engine contain carbon monoxide, a colorless and odorless gas. Do not breathe the engine exhaust gas. A poorly maintained, damaged or corroded exhaust system can allow carbon monoxide to enter the cab. Entry of carbon monoxide into the cab is also possible from other vehicles nearby. Failure to properly maintain your vehicle could cause carbon monoxide to enter the cab and cause illness or death.



#### WARNING!

Never idle your vehicle for prolonged periods of time if you sense that exhaust fumes are entering the cab. Investigate the cause of the fumes and correct it as soon as possible. If the vehicle must be driven under these conditions, drive only with the windows open. Failure to repair the source of the exhaust fumes may result in personal injury, death, equipment or property damage.



#### NOTE

Keep the engine exhaust system and the vehicle's cab ventilation system properly maintained.

It is recommended that the vehicle's exhaust system and cab be inspected:

- By a competent technician every 15,000 miles
- Whenever a change is noticed in the sound of the exhaust system
- Whenever the exhaust system, underbody or cab is damaged

**Engine Lubrication**

Refer to the engine manufacturer's Engine Operation and Maintenance Manual supplied with your vehicle for information about draining and refilling engine oil, engine crank case capacity, engine oil type, and changing oil filters, etc.

	<b>WARNING!</b>
<p>Hot engine oil can be dangerous. You could be burned. Let the engine oil cool down before changing it. Failure to comply may result in personal injury, death, equipment or property damage.</p>	

<b>Lubricant Symbol Key</b>	
ATF	MD3 or MERCON®-approved automatic transmission fluid
BB	High temperature ball bearing grease. Chevron SRI Mobile Grease HP, Texaco Multifax 2 or equivalent
CD50	SAE50W synthetic transmission fluid
CJ-4	Engine oil for PACCAR MX and Cummins ISX engines
CL	Multipurpose chassis grease
EP	Extreme Pressure Lubricant (Lithium 12-hydroxystearate base NGLI 2)
GL	Straight mineral gear lubricant
HD	Hypoid Gear Oil, A.P.I. - GL-5, SAE 75W-90FE synthetic gear lubricant
HT	High Temperature grease (Timken Spec. 0-616)
MP	Multipurpose gear lubricant (MIL-L-2105B)
DOT3 or DOT4	Brake Fluid

# ENGINE MAINTENANCE

## Inspection of the Engine Oil Level

i	NOTE
It takes approximately 15 minutes for all the oil to run into the sump when the engine is 'warm.' If the level is checked immediately after switching off the engine, the dipstick will show a low oil level.	

1. Make sure that the vehicle frame rail is standing on a flat and level surface.
2. Make sure that the vehicle is horizontal, both lengthwise and crosswise. Check this carefully on a vehicle with air suspension. Note that the engine may be inclined up to 4° depending on the vehicle model and wheelbase.
3. Twist the dipstick handle to unlock it, then pull the dipstick out of the holder.

4. Wipe the dipstick clean with a lint-free cloth.
5. Place the dipstick back into the holder.
6. Pull the dipstick out again and check the oil level. The oil level should always be between the 2 marks on the dipstick.
7. Reinstall the dipstick and twist to lock it in place.

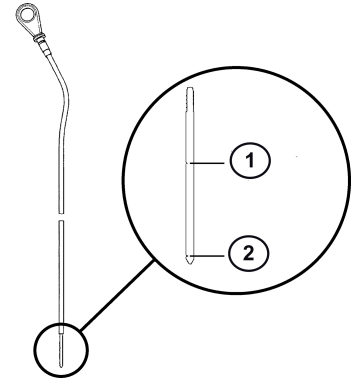

1. Engine Oil High Level
2. Engine Oil Low Level

## Topping Up the Engine Oil

1. Top up with oil, if necessary, via the filler opening. Use the correct grade in the correct quantity. For oil replacement, please see engine Operator's Manual included with this chassis.
2. After topping up, wait 1 minute and check the oil level again.

3. Reinstall the oil fill cap and twist to lock it in place.

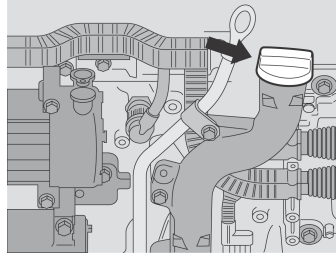

## Pipe and Hose Clamps

Use the following table for torque specifications to check pipe and hose clamps.

**Table 13 Pipe and Hose Clamp Torque Values**

APPLICATION	APPROVED CLAMP	TORQUE	
		Nm	Lb-In
Radiator & Heat Exchanger Hoses	Constant-Torque CT-L	10.2-12.5	90-110
Heater Hoses	Constant Tension	not required	not required
Air Intake Pipes	Hi-Torque HTM-L	11.3-14.2	100-125
Charge Air Intake Hoses	Flex Seal 667	7.9-11.3	70-100
	B9296	6-7	50-60
Fuel, Oil & Water Heat Exchangers (for hoses less than 9/16 diameter)	Miniature 3600L	1.1-1.7	10-15
Exhaust Clamps	Breeze V-Band	54	480

## Fuel System

Please follow these recommendations when you are changing your fuel filters or strainer elements. Your vehicle's engine will run better and last longer if you do. See the engine manufacturer's recommendations for proper water and micron requirements.

### Installing Fuel Filters

When removing filters, cover any electrical equipment and wiring that might get soaked with fuel. Diesel fuel may permanently damage electrical insulation.

#### When installing spin-on (throwaway) filters:

1. Pre-fill filter with fuel.
  2. Moisten gasket with diesel fuel.
  3. Hand tighten them only to 1/2 - 2/3 turn after gasket contact. Mechanical tightening of these filters may distort or crack the filter head.
- When replacing a fuel filter element, do not use a substitute. Install only filter elements designed for fuel filtration. First clean and inspect the shell. Then insert the new element and fill the container

at least 2/3 full of clean fuel before installing the shell.

i	NOTE
To expel air from density-type strainer elements, soak them in clean fuel before installing them.	

- Throw away old gaskets. Replace them with new ones to ensure a positive seal.
- Position the shell and gasket properly. Then tighten the cover nut or bolt just enough to prevent fuel leakage.
- After starting the engine, check for leaks around the filter.



## Filter Draining

1. Check fuel filter/water separator daily. Check with engine OFF. Depending on the fuel storage facility, more frequent draining may be required.
2. Open drain valve (by hand only): turn valve screw counter clockwise approximately 1- to 2 turns until draining occurs. Drain filter sump of water until clear fuel is visible.
3. If entrapped water exceeds sump volume, you can either:
4. Close valve and run engine until smooth idle is established, then repeat drain procedures.
5. Remove filter from mounting head, completely drain all fluid, and reassemble filter assembly. Be sure to follow new filter assembly instructions.

6. Close drain valve by turning valve screw clockwise approximately 1- to 2 turns.

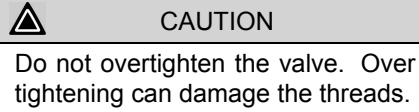

## Accessory Drive Belts

You can avoid costly downtime by periodically checking belt wear and replacing worn and damaged belts. Neglect could cause belt failure. The result could be the loss of the electrical or air system as well as possible engine damage from overheating. So, it is a good idea to check the belts frequently and replace them as soon as you detect trouble.

# ENGINE MAINTENANCE

---

## Engine Fan

### Thermatic (Clutch) Type Fan



#### WARNING!

Do not work on the fan with the engine running. The engine fan can engage at any time without warning. Anyone near the fan when it turns on could be injured. Before turning on the ignition, be sure that no one is near the fan.

#### To check the fan:

- Check the fan assembly mounting bolts for tightness. Inspect the blades for damage.
- Check the clutch operation by starting the engine when it is cold. Then idle it at about 800 rpm. Listen for air leaks.

## Fan Drive and Blade

**Fan Blade Clearance:** Around the fan shroud, the recommended distance is 1 in. (25 mm) from front edge of any fan blade-to-radiator side member. Minimum clearance is 3/4 in. (19 mm).

- Rear edge of any blade must be no closer than 3/8 in. (9 mm) to the nearest engine component. If this cannot be obtained, the fan spacer or fan is not correct.
- The leading edge of any fan blade must be 1 in. (25 mm) from the inside edge of the shroud.

## Exhaust System

The exhaust system is part of the noise control system. Periodically check the exhaust for wear and loose or missing parts. For details see Noise and Emission Control on page 5-109.

## Engine Mounting

**Periodic Inspection:** Inspect engine mounts every 60,000 miles (96,560 km). Check for the following:

- Inspect both mount and leg fasteners. Check for loose or broken bolts. Replace as necessary.
- Check mount and leg for fractures, breaks or deformation. Replace as necessary.
- Check for complete insertion of motor mount. Replace as necessary.
- New leg to mount flange head bolts should be torqued to 210-230 lb-ft (284-311 Nm).



### CAUTION

Do not re-torque or reuse existing flange head bolts. These bolts are factory set to the specified torque. If bolts are loose or damaged, they must be replaced with the new bolts. Failure to comply may result in equipment or property damage.

## All Models

Proper operation, driving techniques and maintenance are key factors in obtaining the maximum service life of the muffler and/or converter. Some precautions should be taken if the engine is equipped with a muffler and converter. Avoid excess idling. Excessive idling or extended low load periods can cause the muffler and converter to plug. A plugged muffler and converter will lead to an increase in exhaust back pressure. Operating the engine in extremely cold conditions can cause the muffler and converter to plug sooner. Use the procedure below to clean out the muffler and converter if extended idle periods or extended low load periods are required.

1. Operate the engine at rated conditions for five to fifteen minutes.
2. Contact an authorized Engine Service Center, if the engine

continues to run at low power or the engine does not respond properly.

### **Multi-Function Message Display**

The Multi-function Display will display diagnostic messages that are intended to alert you that trouble may be developing in one of the systems, do not ignore these messages, they are important indicators that your vehicle should be serviced immediately.

See your Kenworth Dealer for trouble shooting and diagnostic information.

## FRAME MAINTENANCE

### Introduction



#### WARNING!

Do not cut, splice or weld frame rails or drill through the top or bottom flanges of the rails. These operations could affect frame rail strength leading to a failure resulting in an accident. Rail failures resulting from such modifications are not warrantable. Failure to comply may result in personal injury, death, equipment or property damage.

### Emergency Welding

Kenworth DOES NOT recommend frame welding. The high heat of welding nullifies the special heat treatment of the rails, greatly reducing the tensile strength of the frame rail. If a frame member becomes cracked from overloading, fatigue, surface damage or a collision, the only permanent repair is to replace the damaged frame member with a new part. In an emergency, a temporary repair may be performed. Observe the following precautions to protect electronic systems during welding operations.

### Welding Precautions

In the event of emergency welding of a frame rail and when welding any other part of your truck or any component attached to your truck, observe the following precautions before welding:

- Disconnect all electronic devices. It is not possible to list all of the electronics that could be affected, but a few examples include the following: alternator, engine Electronic Control Unit (ECU), transmission ECU, ABS ECU, navigation devices, diagnostic devices, and monitoring devices.
- Disconnect battery cables and insulate them from the vehicle.
- Do not use the ECU or engine ground stud for the ground of the welding probe.
- Ensure that the ground connection for the welder is as close to the weld point as possible. This ensures maximum weld current and minimum risk to damage of electrical components on the vehicle.

# FRAME MAINTENANCE

---

## Painting

Do not electrostatically paint your truck or any component on your truck without first removing all of the electronic components from the truck. It is not possible to list all of the electronics that could be affected, but a few examples include the alternator, engine Electronic Control Unit (ECU), transmission ECU, ABS ECU, navigation devices, diagnostic devices, and monitoring devices.

## Fifth Wheel Maintenance

Proper preventive maintenance is essential to trouble-free service and safe operation of the fifth wheel.

### Every 2 Months or 25,000 Miles:

- Refer to specific manufacturer's literature for any special instructions.
- Steam clean the fifth wheel.
- Check lock guard operation using a commercial lock tester.
- Clean and oil all moving parts.
- Lubricate the following part with a lithium-base grease.
  - Lock mechanism
- All grease fittings (especially those which grease the top surface of the fifth wheel).

### Every 6 Months or 50,000 Miles:

- Refer to specific manufacturer's literature for any special instructions.
- Remove fifth wheel from vehicle. Refer to the Kenworth Shop Manual, "Fifth Wheel Removal."
- Steam clean the fifth wheel and mounting brackets.
- Check all moving parts for excessive wear or damage. Replace all worn or broken parts.
- Complete two-month service procedure.
- Install fifth wheel. Refer to the Kenworth Shop Manual, "Fifth Wheel Installation."

## Frame Fastener Torque Requirements

- Tighten all frame fasteners with a torque wrench. Torque specifications apply to the following fasteners with lightly lubricated threads.

	<b>NOTE</b>
Whenever possible, torque all frame fasteners on the nut end, not the bolt head.	

**Table 14 Standard Grade 8 UNF or UNC and Metric**

FAS-TENER SIZE	TORQUE *	
	Nm	lb-ft
5/16	22-30	16-22
3/8	41-54	30-40
7/16	75-88	55-65
1/2	109-122	80-90
9/16	156-190	115-140
5/8	224-265	165-195
3/4	394-462	290-340
7/8	517-626	380-460
1	952-1,129	700-830
1-1/8	1,346-1,591	990-1,170
1-1/4	1,877-2,217	1,380-1,630
METRIC WITH NYLON INSERT NUTS		
M5	8-12	6-9
M6	9-15	7-11
M8	23-31	17-23

FAS-TENER SIZE	TORQUE *	
	Nm	lb-ft
M10	33-43	24-32
M12	75-101	55-75
M16	163-217	120-160
M20	352-460	260-340
* ESNA Style Lock Nut, with nylon insert. Lubricate nylon insert nut lightly with SAE 20/30 oil.		

## FRAME MAINTENANCE

---

### Sliding Fifth Wheels

- Lubricate bearing surface of support bracket through the grease fittings on the side of the fifth wheel plate. Use a water resistant lithium-base grease.

	NOTE
The plate must be lifted up slightly to relieve the weight of the bracket while applying grease.	



## FRONT AXLE AND SUSPENSION MAINTENANCE

### Axle Lubrication

See the axle manufacturer's operator's manual for lubrication specifications and service intervals.

### Kingpin Lubrication

- Lubricate with approved lubricant. Lubricate knuckle thrust bearings, knuckle pins, and tie rod ends. See Table 6, Recommended Lubrication Intervals on page 5-11. Lack of lubrication causes premature wear and hard steering. Lubrication schedule may be shortened if necessary.

### Suspension Lubrication

Each standard spring anchor pin has a grease fitting. Pressure lubricate spring pins as specified. See Table 6, Recommended Lubrication Intervals on page 5-11.

- At regular intervals, the spring leaves may be lubricated with a rust-inhibiting oil applied with a spray gun or brush.
- Depending on your suspension, lubricate all spring pins until grease flows out of both ends of the bushing. Look for signs of rust or water in the flushed grease. If a pin will not accept grease, it should be removed, cleaned, and inspected.



#### CAUTION

Do not spray the suspension with chemical products or mineral oil; it can cause damage to the bushings.

# FRONT AXLE AND SUSPENSION MAINTENANCE

---

## Inspection

- For all vehicles, mandatory maintenance procedures include retightening all U-bolts and inspecting the suspension for loose fasteners, abnormal wear, or damage. However, even with proper maintenance, the service life of leaf springs is affected by many factors, such as: fatigue, vehicle gross weight, type of load, road conditions, and vehicle speed.
- Check for cracks, wear marks, splits, or other defects on the surface of the spring. Defective parts must be replaced. Because repaired springs cannot be fully restored to their original service life, replace the complete assembly if cracks or other defects are detected.
- Visually inspect shock absorbers and rubber bushings.

## Wheel Alignment

For driving safety and comfort, and to prolong the life of your vehicle, it is important to have wheels correctly aligned. Check tire wear frequently. Uneven tire wear is a sign that the wheels may be misaligned.

If you see uneven wear, take your vehicle to a Kenworth Dealer familiar with aligning wheels on Kenworth vehicles.

## U-Bolt Torque

It is important that U-bolts remain tight. Severe use of your vehicle will cause them to loosen faster. But all vehicles need to have their U-bolts checked and tightened regularly. Be sure someone with the proper training and the right tools checks and tightens the U-bolts on your Kenworth.

New springs can settle in after service, relieving the tension on the U-bolts. Loose U-bolts can cause leaf spring breakage, axle misalignment, hard steering and abnormal tire wear.

- All vehicles should have suspension U-bolts tightened after the first 500 miles (800 km) of operation. And re-torque the front spring pinch bolts and shackle pinch bolts.

## FRONT AXLE AND SUSPENSION MAINTENANCE

 **WARNING!**

Do not operate the vehicle if the U-bolts are not properly tightened. Loose U-bolts will cause the axle to not be properly secured to the suspension, which could cause loss of vehicle control and an accident. Loose U-bolts can also cause uneven tire wear and poor alignment. Failure to comply may result in personal injury, death, equipment or property damage.

U-bolts are difficult to tighten unless you have the right equipment. If you cannot tighten them correctly yourself, be sure to have them checked and tightened regularly by an authorized mechanic.

Tighten U-bolt nuts to the specified torque value with the vehicle loaded to its normal gross weight. The following torque values apply to U-bolts and nuts with clean threads lubricated with

Chevron zinc lubricant (SAE 20 or 30 oils acceptable but not preferred).

 **WARNING!**

Do not replace U-bolts and nuts with common U-bolts or standard nuts. These parts are critical to vehicle safety. If the wrong U-bolts or nuts are used, the axle could loosen or separate from the vehicle and cause a serious accident. Use only U-bolts and nuts of SAE Grade 8 specification or better. Failure to comply may result in personal injury, death, equipment or property damage.

Table 15 Front Spring Suspension U-Bolts, Grade 8

U-BOLT SIZE DIAMETER (Inch Dimensions)	TORQUE	
	Nm	lb-ft
3/4	333-408	245-300
7/8	598-734	440-540
1	925-1,060	680-780
1-1/8	1,470-1,660	1,080-1,220
1-1/4	1,890-2,120	1,390-1,560
1-1/2	3,130-3,860	2,300-2,840

# HEATER AND AIR CONDITIONER MAINTENANCE

## HEATER AND AIR CONDITIONER MAINTENANCE

### Introduction

The combination heater-air conditioner provides comfort for those in the cab through accurate control of the cab environment in all weather conditions. Regular attention to the items below will help you keep the heater-air conditioner unit running well.

	<b>NOTE</b>
Keep the vehicles ventilation system, engine exhaust system and cab joints properly maintained.	

It is recommended that the vehicles exhaust system and cab be serviced as follows:

- Inspected by a competent technician every 15,000 miles (24,000 km)
- Whenever a change is noticed in the sound of the exhaust system
- Whenever the exhaust system, underbody or cab is damaged

	<b>NOTE</b>
To allow for proper operation of the vehicle ventilation system, proceed as follows:	

- Keep the inlet grille at the base of the windshield clear of snow, ice, leaves and other obstructions at all times.
- Keep the exhaust pipe area clear to help reduce the buildup of exhaust gas under the vehicle.

### Special Precautions

	<b>WARNING!</b>
Excessive heat may cause the pressurized components of the air conditioning system to explode. Never weld, solder, steam clean, or use a blow torch near any part of the air conditioning system. Failure to comply may result in personal injury, death, equipment or property damage.	

- **If a refrigerant leak develops in the presence of excessive heat or an open flame, hazardous gases may be generated. These gases may cause unconsciousness or death. If you become aware of a refrigerant leak on your vehicle have your system service immediately and observe the following precautions:**

- **Stay away from the hot engine until the exhaust manifold has cooled.**
- **Do not permit any open flame in the area. Even a match or a cigarette lighter may generate a hazardous quantity of poisonous gas.**
- **Do not smoke in the area. Inhaling gaseous refrigerant through a cigarette may cause violent illness.**

## Heater

- Check all heater controls for full-range operation.
- Check hoses, connections, and heater core for condition and leaks.
- Check the drain tube of the fresh air inlet for trapped water before assuming that there is a leak in the heating system. If the heater core is leaking, a reliable radiator shop should be able to repair it.
- Check the heater core for debris blocking the air flow. If the blower and air controls are functioning properly, yet the heater is not operating properly, the heater core or the hot water valves may be clogged or closed. Clean the heater core if necessary. If the condition persists, take the vehicle to a Kenworth Dealer for proper heater service or repair.



### CAUTION

During extreme cold weather, do not blow hot defroster air onto cold windshields. This could crack the glass. Turn the air direction lever to Defrost and adjust the fan speed accordingly while the engine warms. If the engine is already warm, move the temperature selector to Cool, then gradually increase the temperature when you see that the windshield is starting to warm-up.

# HEATER AND AIR CONDITIONER MAINTENANCE

## Air Conditioner

5

 <b>WARNING!</b>
The air conditioning system is under pressure. If not handled properly during servicing, it could explode. Any servicing that requires depressurizing and recharging the air conditioning system must be conducted by a qualified technician with the right facilities to do the job. Failure to comply may result in personal injury, death, equipment or property damage.

- Check the compressor and drive clutch for noise and vibration. If you find problems, have the system checked thoroughly. A malfunctioning clutch usually indicates trouble elsewhere in the system.
- Check the evaporator core, filter, and condenser core for debris restricting air flow. Clean if

necessary. Small particles may be removed with compressed air blown through the core in the opposite direction of normal air flow.

 <b>WARNING!</b>
Wear eye protection any time you blow compressed air. Small particles blown by compressed air could injure your eyes.

- Inspect and clean cab air filter element every 3 - 6 months of service. Depending on the operating environment, if air flow from the air conditioner and heater is less efficient or windows fog easier, you may need to replace the cab air filter.
- Check the compressor belt for condition and proper tension.
- Check all hoses for kinks, deterioration, chafing, and leaks.

Adjust kinked or chafing hoses to eliminate restrictions and prevent further wear.

- Check all components and connections for refrigerant leaks. If you discover a leak, do not try to tighten a connection. Tightening a connection may cause a worse leak. Have a qualified technician correct the problem.

 <b>NOTE</b>
A leaking evaporator or condenser core cannot be repaired; it must be replaced.

Have the air conditioning system fully serviced annually by your Kenworth Dealer. Qualified service technicians will have to evacuate and recharge the system.

# NOISE AND EMISSION CONTROL MAINTENANCE

## Noise Emission Warranty

Kenworth Truck Company warrants to the first person who purchases this vehicle (for purposes other than resale) and to each subsequent purchaser: that this vehicle, as manufactured by Kenworth Truck Company, was designed, built and equipped to conform, at the time it left Kenworth's control, with all applicable U.S. EPA Noise Control Regulations.

This warranty covers this vehicle as designed, built and equipped by Kenworth, and is not limited to any particular part, component or system of the vehicle manufactured by Kenworth.

Defects in design, assembly or in any part, component or system of the vehicle as manufactured by Kenworth, which at the time it left Kenworth's control caused noise emissions to exceed Federal standards, are covered by this warranty for the life of the vehicle.

## Tampering with Noise Control System

**Federal law prohibits the following acts or the causing thereof:**

1. The removal or rendering inoperative by any person other than for purposes of maintenance, repair, or replacement, of any device or element of design incorporated into any new vehicle for the purpose of noise control prior to its sale or delivery to the ultimate purchaser or while it is in use, or
2. The use of the vehicle after such device or element of design has been removed or rendered inoperative by any person.

# NOISE AND EMISSION CONTROL MAINTENANCE

---

Among those acts presumed to constitute tampering are the acts listed below:

## Air Intake System

- Removing or rendering inoperative the air cleaner/silencers or intake piping.

## Engine Cooling System

- Removing or rendering inoperative the fan clutch.
- Removing the fan shroud.

## Engine

- Removing or rendering engine speed governor inoperative so as to allow engine speed to exceed manufacturer's specifications.
- Modifying ECU parameters.

## Exhaust System

- Removing or rendering inoperative exhaust system components.

## Fuel System

- Removing or rendering engine speed governor inoperative, allowing engine speed to exceed manufacturer's specifications.
- Removing of air signal attenuator on engines equipped with this device.

## Inner Fender Shields and Cab Skirts

- Removing shield or skirts.
- Cutting away parts of shields, skirts or damaged or loose portions of shields or skirts.

## Noise Insulating Blankets

- Removing noise insulators from engine block or from around the oil pan.

- Cutting holes in, or cutting away part of noise insulators.
- Removing hood-mounted noise insulation.



## Inspection and Maintenance Instructions

The following instructions are based on inspection of the noise control system at regular intervals as indicated in the Noise Control System Maintenance Log on page 5-117.

If, during periodic inspection and maintenance of other systems and components, it is found that parts of the noise control system require attention, we recommend that those parts be inspected at more frequent intervals to assure adequate maintenance and performance.

### Air Intake System

- Do all checks and maintenance procedures listed in this manual under Engine Air Intake System and Air Cleaner. See Air Dryer on page 4-18.
- Check the induction tubing, elbow connections, clamps, brackets, and fasteners for deterioration, cracks, and security.
- If you find an air leak anywhere between the air cleaner and the engine, repair that leak immediately.

	<b>CAUTION</b>
Air leaks cause excessive noise and may result in serious damage to the engine. If you do not repair them the engine damage will not be covered by your warranty. Repair all air leaks as soon as you find them.	

### Engine Mounted Noise Insulators

- Check condition. Is the insulator secure? How you do this will depend on the method of attaching the noise insulators on the engine and around the oil pan (bolts, snap fasteners, or straps). Tighten loose fasteners and repair or replace any worn or damaged fasteners.
- Check insulators around fasteners and stress points, especially where they may be affected by engine vibration. Repair any cracked or damaged mounting points. Use suitable reinforcing plates to ensure that the insulators will remain in position.

## NOISE AND EMISSION CONTROL MAINTENANCE

---

### Exhaust System

- Check for exhaust leaks, which would indicate a leaking manifold gasket; replace gasket if necessary.
- Check cap screws for tightness, including those at the flanges. Refer to the engine manufacturer's service manual for proper tightening sequence and torque values.

### Joints and Clamps

- Check for leaks, and tighten as necessary. Check for deterioration or dents in pipes and clamps which could allow exhaust to escape.

### Selective Catalyst Reduction (SCR)

- Check SCR canister filter, clamps and mounting brackets. Tighten if necessary. Inspect SCR canister for signs of rust or corrosion.

# NOISE AND EMISSION CONTROL MAINTENANCE

---

## Exhaust Piping

- Check exhaust piping for rust, corrosion, or damage. Replace deteriorated piping before holes appear. If piping is perforated at any point, temporary patching or lagging is acceptable until you can have permanent repairs made. On turbocharged engines, check joints at flanges and mounting brackets for tightness.

## Diesel Particulate Filters (DPF)

- Check the DPF, clamps, and mounting brackets. Tighten if necessary. Inspect the DPF for signs of rust or corrosion.
- Check internal baffling. You can do this by listening for rattling sounds while tapping on the DPF with a rubber mallet or revving the engine up and down through its normal operating range.

## Mufflers

- Check muffler, clamps, and mounting brackets. Tighten if necessary. Inspect muffler for signs of rust or corrosion.
- Check internal baffling. You can do this by listening for rattling sounds while tapping the muffler with a rubber mallet or revving the engine up and down through its normal operating range.

# NOISE AND EMISSION CONTROL MAINTENANCE

---

## Exhaust Tail Pipe

- Check the mounting. Tighten as necessary. The miter cut at the tip of the pipe must be facing the rear of the vehicle. Do not modify the end of the pipe in any way.

## Engine Fan and Shroud

 <b>WARNING!</b>
Do not work on the fan with the engine running. The engine fan can engage at any time without warning. Anyone near the fan when it turns on could be injured. Before turning on the ignition, be sure that no one is near the fan.

- Check all fasteners for tightness. Check for stress cracks in the shroud. Make sure the shroud is adjusted so that it does not touch the fan blades.
- Check to verify that the fan is disengaged (not turning) with the engine running at normal operating temperatures (from cold to the point that the fan engages).
- Check fan blade mounting bolts. Inspect fan blades to be sure they are not cracked or bent.

## Transmission and Driveline

- Substituting a different main transmission or driveline components, other than design-specified units, may result in increased vehicle noise emission.

## NOISE AND EMISSION CONTROL MAINTENANCE

---

### Hood Insulation Blanket

- Check all fasteners for condition and security. Repair or replace any broken or defective fasteners.

### Blanket

- Check for chafing or tears. Patch it if necessary. Find the cause of the damage. If any component or accessory is causing wear or damage and cannot be relocated, put reinforcing pads on the blanket at the site of wear.

### Inner Fender Shields and Cab Skirts

- Check all fasteners, especially the self-tapping hex head screws. Are they secure? Remove and replace any loose rivets.

# NOISE AND EMISSION CONTROL MAINTENANCE

---

## Shields and Skirts

- Check shields and skirts for cracks at mounting and stress points. Check fender shields for tire marks, worn spots, or damage from objects thrown from tire treads. You can repair cracked or damaged fiberglass fender shields with fiberglass and resin.
- If you find damage at a fastening point, you can gain additional strength by installing a suitable reinforcing plate. This plate should be drilled to accept a rivet and laminated to the shield with fiberglass and resin.
- Check cab skirts, sills, and brackets for overall condition and repair them as necessary. Damaged rubber fender shields or cab skirting cannot be repaired. You will need to replace it.

i	NOTE
Your Kenworth Dealer can perform all of these checks and repairs or replacements.	

## Noise Control System - Maintenance Log

To ensure your Kenworth's noise control requirements are maintained, record maintenance checks. Use the following log sheet and retain copies of documents regarding maintenance services performed and parts replaced on the vehicle.

# NOISE AND EMISSION CONTROL MAINTENANCE

**Table 16 Noise Control System - Maintenance Log**

Component	Recommended Interval (Miles)	Date & R.O. No.	Repair Facility & Location	Work Performed	Date & R.O. No.	Repair Facility & Location	Work Performed
Exhaust System Routing Integrity	25,000						
Shutters Shrouds	25,000						
Hood Insulation Blanket	10,000						
Engine Mounted Hose Insulators Fasteners	10,000						
Inner Fender Shields	50,000						
Cab Skirts Fasteners	50,000						
Air Intake System Integrity Element	5,000						

# NOISE AND EMISSION CONTROL MAINTENANCE

Component	Recommended Interval (Miles)	Date & R.O. No.	Repair Facility & Location	Work Performed	Date & R.O. No.	Repair Facility & Location	Work Performed
Clutch Type Fan Drive	10,000						



## REAR AXLE AND SUSPENSION MAINTENANCE

### General Maintenance



#### WARNING!

Do not work on the vehicle without the parking brake set and wheels chocked securely. If the vehicle is not secured to prevent uncontrolled vehicle movement, it could roll and may result in personal injury, death, equipment or property damage.



#### NOTE

Use wood blocks (4 in. X 4 in. or larger) against the front and rear surfaces of the tires. Be sure the vehicle cannot move.

Your vehicle's suspension, by design, requires a minimal amount of maintenance. However, suspensions in over-the-road operations require periodic inspection to ensure trouble-free performance.



#### WARNING!

Do not operate the vehicle if the U-bolts are not properly tightened. Loose U-bolts will cause the axle to not be properly secured to the suspension, which could cause loss of vehicle control and an accident. Loose U-bolts can also cause uneven tire wear and poor alignment. Failure to comply may result in personal injury, death, equipment or property damage.



#### WARNING!

Failure to maintain the specified torque values or to replace worn parts can cause component system failure, possibly resulting in an accident. Improperly tightened (loose) suspension U-bolts can lead to unsafe vehicle conditions, including: hard steering, axle misalignment, spring breakage or abnormal tire wear. See Front Spring Suspension U-bolts on page 5-105 for proper torque specifications. Failure to comply may result in personal injury, death, equipment or property damage.



#### CAUTION

Do not spray the suspension with chemical products or mineral oil; it can cause damage to the bushings.

## REAR AXLE AND SUSPENSION MAINTENANCE

---

	NOTE
Failure to follow these recommendations could void warranty.	

### Visual Inspection

For all vehicles, mandatory maintenance procedures include retightening of U-bolts and complete inspection. However, even with proper maintenance, many factors affect the service life of springs and suspension components, such as: fatigue, vehicle gross weight, type of load, road conditions and vehicle speed.

It is important that U-bolts remain tight. Severe use of your vehicle can cause them to loosen faster. But all vehicles need to have their U-bolts checked and tightened regularly. Be sure someone with the proper training and the right tools checks and tightens the U-bolts on your Kenworth.

- After the first 500 miles (800 km) of operation, inspect the suspension periodically, as noted below:

- Visually check for loose or missing fasteners, cracks in hanger or axle connection brackets.
- Check that springs are centered in hangers and in good condition.
- Check for cracks, wear marks, splits, or other defects on the surface of the spring.
- Replace defective parts. Because repaired springs cannot be fully restored to their original service life, replace the complete assembly if cracks or other defects are detected.
- After replacement of any part or discovery of loose components, check the torque of all fasteners.
- New springs settle-in after the vehicle's initial service, causing the U-bolts to become loose.

## Rear Suspension Fasteners

To maintain the performance of the air suspension, check fastener torque values after the first 2,000 miles (3,218 km) of service and every 60,000 miles (96,000 km) thereafter.

Torque recommendations apply to fasteners supplied and installed by Kenworth. The values listed in Table 17 and Table 18 below, are for cadmium plated or phosphate and oil fasteners only.

U-bolts are difficult to tighten unless you have the right equipment. If you cannot tighten them correctly yourself, be sure to have them checked and tightened regularly by an authorized mechanic.

### U-Bolt Torque

	<b>NOTE</b>
<p>To ensure an accurate torque reading, use properly maintained and calibrated torque wrenches.</p> <ul style="list-style-type: none"> <li>Clean the nut and bolt. No dirt, grit, or rust should be present.</li> </ul>	

	<b>WARNING!</b>
<p>Do not operate the vehicle if the U-bolts are not properly tightened. Loose U-bolts will cause the axle to not be properly secured to the suspension, which could cause loss of vehicle control and an accident. Loose U-bolts can also cause uneven tire wear and poor alignment. Failure to comply may result in personal injury, death, equipment or property damage.</p>	

	<b>NOTE</b>
Torque all fasteners on the nut end.	

**Table 17 Rear Suspension Fasteners (Metric & Standard)**

SIZE/ TYPE	TORQUE*	
	Nm	LbFt
M16 nylon-insert nuts	163-217	120-160
M20 nylon-insert nuts	352-460	260-340
M20 all-metal lock nuts	427-475	315-350
1/2 in. nut	109-122	80-90
3/4 in. nut	394-462	290-340
1-1/4 in. nut	1,877-2,217	1,380-1,630
<p>* Torque requirements apply to Kenworth proprietary suspensions. All other suspensions must refer and adhere to original manufacturers shop manual.</p>		

# REAR AXLE AND SUSPENSION MAINTENANCE

**Table 18 Rear Suspension U-Bolts, Grade 8 (lubricated\*)**

U-BOLT SIZE DIAMETER THREAD	TORQUE**	
	Nm	lb-ft
3/4	333-408	245-300
7/8	598-734	440-540
1	925-1,060	680-780
1-1/8	1,470-1,660	1,080-1,220
1-1/4	1,890-2,120	1,390-1,560
1-1/2	3,130-3,860	2,300-2,840

\* Chevron Zinc Lubricant or SAE 20/30 oil should be used on U-Bolt threads

\*\* Torque requirements apply to manufacturer proprietary suspensions. All other suspensions must refer and adhere to original manufacturers shop manual.

- Load the vehicle to its normal gross weight before tightening U-bolts. Loading the vehicle

ensures proper adjustment of the U-bolt and spring assembly.

 <b>WARNING!</b>
Do not replace U-bolts and nuts with common U-bolts or standard nuts. These parts are critical to vehicle safety. If the wrong U-bolts or nuts are used, the axle could loosen or separate from the vehicle and cause a serious accident. Use only U-bolts and nuts of SAE Grade 8 specification or better. Failure to comply may result in personal injury, death, equipment or property damage.

## Rear Axle Lubrication

See the axle manufacturer's operator's manual for lubrication specifications and service intervals.

### Rear Axle Alignment

Continual road shock and load stresses may force the rear axles out of alignment. If you detect rapid tire wear on the rear axles, you may have misaligned axles. If you suspect rapid tire wear, have your rear axle alignment checked and adjusted by a Kenworth Dealer.

In addition to pre-delivery inspections, suspension alignment should be checked when any one of the following conditions exist:

- Discovery of loose suspension fasteners. (Loose, defined as any torque below the recommended torque value.)
- Discovery of elongated holes in a suspension component.
- Bushing replacement.
- Excessive or abnormal tire wear.

## STEERING AND DRIVELINE MAINTENANCE

### STEERING AND DRIVELINE MAINTENANCE

#### Power Steering

Oil (under low pressure) provides the power to operate the steering gear. It also serves to lubricate moving parts and remove heat. A loss of steering efficiency will occur if too much heat builds up in the system.

 <b>WARNING!</b>
Do not operate the vehicle if the steering system is not working properly. You could lose control of your vehicle if the steering system is not in good working condition, which could result in a serious accident. For driving safety, visually check the steering gear and components. Frequent checks are important for driving safety, especially after traveling over rough roads. Failure to comply may result in personal injury, death, equipment or property damage.

 <b>NOTE</b>
If the steering feels unbalanced from side-to-side while turning, check for the following possible causes:

- unequal tire pressures

- vehicle overloaded or unevenly distributed load
- wheels out of alignment
- wheel bearings improperly adjusted

If you cannot correct the problem, check with an authorized Kenworth Dealer.

The Kenworth is equipped with integral power steering. The system includes an engine-driven fluid pump, a fluid reservoir, the steering gear, and connecting hoses. Because of the hydraulic power assist, little effort is required to turn the steering wheel. When no input is applied through the steering wheel, the steering gear will return to the neutral position. If, for any reason, the power assist system goes out, steering the vehicle is still possible, yet it will require much greater effort.

Visually check the following parts:

- Crosstube: Is it straight?
- Draglink tube clamp: Check for looseness or interference.
- Ball joints and steering U-joints: Check for looseness.
- Steering wheel for excessive free-play. Check the simplest probable causes first:
  - unequal tire pressures
  - loose cap nuts
  - bent crosstube
  - lack of lubrication
- If these checks do not reveal the problem, or if you correct them and still have a steering problem, take your truck to an authorized Kenworth Dealer for evaluation.

## Fluid Level and Refill

Have the power steering fluid and filters changed at an authorized Kenworth Dealer.

- Check and completely change the fluid level according to Table 6, Recommended Lubrication Intervals on page 5-11. Use the following procedure:

<b>i</b>	<b>NOTE</b>
Before removing reservoir cover, wipe outside of cover so that no dirt can fall into the reservoir.	

- Maximum/Minimum level is indicated on the reservoir. These same levels are also indicated by two lines on the dipstick in the reservoir.
- There are two ways to check whether the power steering fluid

is at its proper level. Both checks are with the engine NOT running.

1. If you check the fluid with the engine and steering system COLD, the fluid level should be at/or above the Minimum indicator level and should generally not exceed the middle point between Maximum and Minimum level indicators.
2. If you check the fluid with the engine and steering system WARM, the fluid should NOT exceed the Maximum level indicator and should generally not drop below the middle point between the Maximum and Minimum level indicators.

# STEERING AND DRIVELINE MAINTENANCE

## Fluid Refill

The following recommendations are for general purpose steering systems, commonly installed on Kenworth vehicles.

- For normal temperatures, use Automatic Transmission Fluid (ATF) Type E or F or Dexron® III.
- For cold temperatures of -22° F (-30° C) and above use ATF Type A.
- For extremely cold temperatures between -22° F (-30° C) and -40° F (-40° C) use ATF Type B.

## Steering Driveline

The following are common torque specifications for most drivelines.

- Torque on U-joint pinch bolt and nut (7/16 in) 74–81 Nm (55 to 60 lb-ft), lubricated.
- Torque on Pitman arm clamp bolt and nut (3/4 in): 406–433 Nm (300 to 320 lb-ft), lubricated.
- For off-highway vehicles, tighten the U-bolts after the first day or two of operation. Then check weekly.



### WARNING!

If any part of the steering system (e.g. linkage, steering driveline, column, front-end alignment, etc) is repaired, removed, or disassembled in any way, or if the steering angle sensor is replaced, the steering angle sensor must be recalibrated. Failure to do so could cause loss of vehicle control. Any repairs or adjustments to any part of the steering system must be performed by an authorized Kenworth Dealer. Failure to comply may result in personal injury, death, equipment or property damage.



### Driveshaft

See the driveshaft manufacturer's operator's manual for lubrication specifications and service intervals.

### TIRES AND WHEEL MAINTENANCE

#### Introduction

Keeping the tires in good condition is essential to the safe, efficient operation of your Kenworth. Regular, frequent inspection and the right care will give you the assurance of safe and reliable tire operation.

#### General Safety Requirements

- **Each mounting system is engineered only for use with its correct mating part. Be sure that properly matched components are used for each type of mounting. The comparison chart, Comparing Hub-piloted and Ball-seat Wheels on page 5-138, illustrates the differences between parts used in hub-piloted mount and ball seat mount applications. Only OEM supplied hub-piloted or ball-seat mounted wheels may be used on this vehicle.**



#### WARNING!

Use only original equipment manufactured (OEM) components. Use of non-original equipment could cause wheel breakage and wheel separation from vehicle. Failure to comply may result in personal injury, death, equipment or property damage.

- **If you are not fully qualified and not equipped with the proper tools and equipment, do not attempt to raise the vehicle or remove or install the damaged tire and wheel assembly. Obtain expert help. A person can be injured and/or damage can result from using the wrong service methods. Truck tires and wheels should be serviced only by trained personnel using proper equipment. Do not reinflate a tire that has been run flat or is low on air without first**

removing the tire from the rim and inspecting for damage.

- Follow OSHA regulations per section 1910.177.
- Do not exceed the speed rating of tires. Exceeding the speed rating may result in sudden tire failure and loss of vehicle control.
- Follow all warnings and cautions contained within the tire and wheel manufacturers literature.
- Only properly trained personnel should service tire and rim assemblies.



### WARNING!

Always support the vehicle with appropriate safety stands if it is necessary to work underneath the vehicle. A jack is not adequate for this purpose. Failure to comply may result in personal injury, death, equipment or property damage.

### Speed Restricted Tires



### WARNING!

This vehicle may be equipped with speed restricted tires. Check each tires sidewall for maximum rated speed. Vehicle should not be operated at sustained speed in excess of maximum rated speed. Failure to comply with these speed restrictions could cause sudden tire failure which may result in personal injury, death, equipment or property damage.

# TIRES AND WHEEL MAINTENANCE

---

## Tire Inspection and Replacement

Visually inspect your tires frequently for any abnormal conditions such as scrapes, bulges, and uneven wear. This must be done immediately after known or suspected contact with an object in the road, with a pothole, road irregularity or after severe braking. Refer these conditions to an Authorized Tire Service Center for repair or replacement. Never drive on a tire if such conditions appear.

If the tire looks under-inflated, stand off to the side and check for damage to the wheel assembly. This can be done by visually comparing the wheel in question to other wheels on the vehicle. For dual wheel assemblies, check between the wheels for damage. If any damage is found, or you suspect damage, do not attempt further repair. Call for expert tire service.

## Tire Inflation and Loading

Low pressure is a tire's worst enemy. Under-inflation allows tires to flex improperly, causing high temperatures to build up. Heat causes early tire damage such as flex break, radial cracks, and ply separation. And low pressure may affect control of your vehicle, especially at the front wheels.



### WARNING!

Do not operate vehicle with under-inflated tires. The extra heat caused by under-inflation can cause sudden tire failure such as a tire fire or blow out. Low pressure may affect control at the front wheels, which could result in an accident. Keep your tires inflated to the manufacturer's recommended air pressure. Failure to comply may result in personal injury, death, equipment or property damage.

## Tire Inflation

Most tire wear problems are caused by under-inflation as the result of slow leaks. So you will want to check tire pressure regularly. Give the tires a visual test every day, and check inflation with a gauge every week.

When checking tire pressure, inspect each tire for damage to sidewalls, cuts, cracks, uneven wear, rocks between dual wheels (tires), etc. If a tire appears under-inflated, check for damage to the wheel assembly. Do not forget to check between dual wheels. If you find wheel damage, have an expert tire service repair it.

**⚠ WARNING!**

Do not repair damaged tires unless you are fully qualified and equipped to do so. Wheel and tire assemblies cannot be worked on without proper tools and equipment, such as: safety cages or restraining devices. Have all tire repairs performed by an expert. And stand away from the tire assembly while the expert is working. Failure to comply may result in personal injury or death.

**⚠ CAUTION**

Pressure should be checked when the tires are cool. Warm or hot tires cause pressure buildup and will give you an inaccurate reading. So never deflate a warm tire to the specified pressure. Failure to comply may result in equipment damage.

**Under-inflated tires will adversely affect the operation of the vehicle and tires:**

- making steering difficult
- causing extra strain on the tire sidewalls
- reducing the tread life of tires due to the high temperatures generated from excess flexing of the tire
- Inflate tires to the manufacturer's cold air pressure specification molded into the tire side wall.

Lower tire pressure does not give you more traction on ice or snow. Under-inflation actually reduces traction and steering control. See the tire manufacturer's Driver's Handbook for more information on proper operation and use of tires.

1



TREAD CONTACT WITH ROAD

**Proper-Inflation:** the correct profile for full contact with the road.

2



TREAD CONTACT WITH ROAD

**Under-Inflation:** causes abnormal tire deflection, which builds up excessive heat, running the risk of failure. It also causes irregular wear.

# TIRES AND WHEEL MAINTENANCE

3



**Over-Inflation:** reduces the tread contact area with the road surface, concentrating all of the vehicle weight on the center of the tread. This causes premature wear of the tire.

- Too much air pressure reduces the tire tread contact area and results in rapid wear in the center of the tire. It also causes tires to run hard and makes them more vulnerable to impact and other road hazard damage.

 <b>WARNING!</b>	
<p>Over-inflated tires can cause accidents. They wear more quickly than properly inflated tires and are more subject to punctures, cracks, and other damage. They could fail and cause you to lose control of your vehicle resulting in an accident. Be sure all tires are inflated correctly according to the manufacturer's recommendations. Failure to comply may result in personal injury, death, equipment or property damage.</p>	

If over-inflation is noted during travel, do not deflate tires. The increased pressure is caused by temperature build-up during operation. This condition has been taken into account during manufacturing of the tires. Allow tires to cool, then recheck and adjust if necessary.

## Tire Loading

 <b>WARNING!</b>	
<p>Do not exceed the load rating of your tires (molded on the side wall of your tire) or the maximum vehicle load rating, whichever is less. Overloading could result in premature tire failure causing you to lose control of your vehicle and result in an accident. The maximum vehicle load rating (GVWR) is found on the Tire and Rim Data label on the driver's door. Failure to comply may result in personal injury, death, equipment or property damage.</p>	

Overloading your vehicle is as damaging to the tires as under-inflation. It significantly affects the expected life (total mileage of a tire). The following chart shows how neglect or deliberate abuse can affect the life of your vehicle's tires.

**Table 19 Effect of Load Pressure on Tire Life**

Vehicle Load	Normal	20% Over	40% Over	60% Over	80% Over	100% Over
Tire Pressure	Normal	20% Low	30% Low	35% Low	45% Low	55% Low
<b>Expected Total Tire Mileage</b>	Normal	70%	50%	40%	30%	25%

## Wheel Mounting and Fastening

After the vehicle travels about 50 to 100 miles (80 to 160 km), wheel mountings seat in and will lose some initial torque. Check hub/wheel mountings after this initial period and retighten.

## Wheel Cap Nut Torque

At the first scheduled lube interval, have all wheel cap nuts torqued to their specified value. See Table 20, Wheel Cap Nut Torque on page 5-133. After that, check wheel cap nuts at least once a week. Contact an authorized Kenworth Dealer for information on the proper installation procedure for the wheels on your truck. This is a job you may not be able to do yourself. You need the right torquing equipment to do it.

	<b>WARNING!</b>
<p>Never use oil or grease on studs or nuts; improper torque readings will result, which could cause improper wheel clamping and could lead to a wheel failure resulting in an accident. Failure to comply may result in personal injury, death, equipment or property damage.</p>	

# TIRES AND WHEEL MAINTENANCE

**Table 20 Wheel Cap Nut Torque**

WHEEL & NUT CONFIGURATION	STUD SIZE	TORQUE FOR INNER & OUTER CAP NUTS & RIM CLAMP NUTS	
		Nm	lb-ft
Steel or Aluminum Disc-Type Wheel; Double Cap Nut Mounting; Standard 7/8 Radius Ball Seat	3/4-16	610-680	450-500
	1-1/8-16	610-680	450-500
Heavy-Duty Steel Disc-Type Wheel; Double Cap Nut Mounting; 1-3/16 Radius Ball Seat:	15/16-12	1,020-1,220	750-900
	1-1/8-16	1,020-1,220	750-900
	1-15/16-12	1,020-1,220	750-900
Hub-Piloted Disc-Type Wheel w/Two Piece Flanged Cap Nuts: Steel or Aluminum Wheel	M22-1.5	610-680	450-500
Stud Backnuts (when used)	3/4-16	240-270	175-200
	1-14	240-410	175-300

5

Threads should be clean and dry. Do not lubricate wheel nuts or studs.

### Proper Torque and Sequence

Proper wheel torque can best be obtained on level ground. Install lug nuts and finger-tighten in the numerical sequence as shown below, see Nut Tightening Sequence for Hub Piloted Disc Wheels on page 5-135 or Nut

Tightening Sequence for Stud Piloted Disc Wheels on page 5-135. This procedure will ensure that the wheel is drawn evenly against the hub. Torque each nut to the torque value listed in Table 20, Wheel Cap Nut Torque.





## WARNING!

Tighten wheel cap nuts properly. If they are not tightened properly, wheel nuts could eventually cause the wheel to become loose, to fail, and/or to come off while the vehicle is moving, possibly causing loss of control and may result in personal injury, death, equipment or property damage.

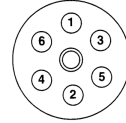
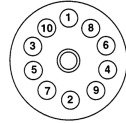

Nut Tightening Sequence for Stud Piloted Disc Wheels

## Wheel Bearing Adjustment

For safe, reliable operation and adequate service life, your wheel bearings must be adjusted properly at the recommended intervals. Contact your authorized dealer to make sure the wheel bearings are properly adjusted.

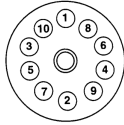
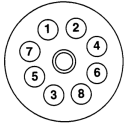

Nut Tightening Sequence for Hub Piloted Disc Wheels

## TIRES AND WHEEL MAINTENANCE

### Wheel Replacement with Disc Brake Option

Use only the wheel brand, size and part number originally installed by Kenworth. Use of a different wheel brand or size could cause valve stem to interfere with a brake component which could lead to loss of vehicle control and may lead to personal injury.

Vehicles equipped with front disc brakes are fitted with wheels designed specifically for disc brake applications. If it ever becomes necessary to replace an original equipment wheel, the replacement wheel must be the same brand and size as the take-off wheel. On vehicles equipped with 22.5 in. disc wheels, installing the wrong replacement wheel could result in the wheel valve stem making contact with the disc brake assembly. When installing any replacement wheel, always inspect the tires/wheels to

ensure there is adequate clearance between other vehicle components.

With the hood open, check for clearance between the wheel and disc brake assembly. Use a hydraulic jack to raise the front of the vehicle off the ground to allow the wheel to spin freely. While rotating the wheel, check to ensure there is adequate clearance between the wheel and disc brake assembly



#### WARNING!

If the hood falls, anyone under it could be injured. Always attach the safety cable and/or hood stop when the hood is in its open position any time anyone gets under the hood for any reason. Failure to comply may result in personal injury, death, equipment or property damage.



#### WARNING!

Always support the vehicle with appropriate safety stands if it is necessary to work underneath the vehicle. A jack is not adequate for this purpose.



#### WARNING!

Improperly mounting and demounting tire and rim assemblies is dangerous. Failure to observe proper precautions could cause the tire-rim assembly to burst explosively, causing serious injury or death. See the wheel manufacturer's literature for the proper way to mount and demount your tires and rims. Follow their precautions exactly.

## Disc Wheels

 <b>WARNING!</b>
<p>Use the correct components and tools when working on wheels. Grooves in the wheel disc or other damage to the disc can weaken the wheel and cause it to eventually come off. This could cause you to lose control of your vehicle, and may result in an accident. Failure to comply may result in personal injury, death, equipment or property damage.</p>

The end of the wheel wrench must be smooth. Burrs on the end of the wrench can tear grooves in the disc. These grooves may lead to cracks in the disc, and can cause it to fail.

## Comparing Hub Piloted and Ball Seat Parts

 <b>WARNING!</b>
<p>Do not mismatch wheel components. Equipment that does not exactly match original specifications or that is mismatched could cause the wheels to break and separate from the vehicle. The resulting accident could be very serious. Each mounting system is engineered for use only with its correct mating part. Be sure properly matched components are used for each type of mounting. Failure to comply may result in personal injury, death, equipment or property damage.</p>

The following comparison (Table 21, Comparing Hub-piloted and Ball-seat Wheels), shows the difference between parts used in hub pilot mount and ball seat mount applications.

# TIRES AND WHEEL MAINTENANCE

Table 21 Comparing Hub-piloted and Ball-seat Wheels

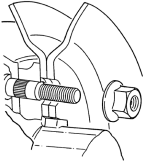
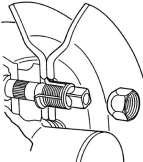
<p style="text-align: center;"><b>HUB-PILOTED MOUNT</b></p> 	<p style="text-align: center;"><b>BALLSEAT MOUNT</b></p> 
<b>Hub, Drum, and Stud Assembly</b>	
<p>Hub-piloted mountings use M22 x 1.5 metric threads (about 7/8 in. diameter). The stud stands out at least 1.94 in. beyond the brake drum. All studs are right-hand threads. Pilot bosses (machined surfaces) on the hub, fit tightly to the wheel center bore.</p>	<p>Ball-seat (stud-piloted) mountings use 3/4x16 or 1-1/8x16 threads. The dual mounting studs provide 1.30 in. 1.44 in. standout. Right-hand and left-hand threads are required. Inner and outer wheel nuts center the wheels by seating against wheel ball seats.</p>
<b>Wheels</b>	
<p>Hub-piloted wheels have stud holes reamed straight through (no ball seats). Center bore diameter is 8-21/32 in.</p>	<p>Ball-seat wheels have spherical chamfers machined on each stud hole. Center bore diameter is 8-23/32 in.</p>
<b>Wheel Nuts</b>	
<p>Hub-piloted wheel nuts have a hex body and a flange for clamping against wheel face. Hex size is 1-5/16 in. (33 mm).</p>	<p>Ball-seat inner and outer wheel nuts mate with spherical chamfers on wheels. The inner nut has 13/16 in. square end. The outer nut has a 1-1/2 in. hex.</p>

## Tire Replacement

Front: replace front tires when less than 4/32 in. of tread depth remains.

Check depth at three places equally spaced around the tire.

Drive Axles or Trailers: replace tires on drive axles when less than 2/32 in. of tread depth remains in any major

groove. Check depth at three places equally spaced around the tire.



## WARNING!

Do not install regrooved or reinforcement-repaired tires on steering axles. They could fail unexpectedly and cause you to lose control of your vehicle resulting in an accident. Failure to comply may result in personal injury, death, equipment or property damage.



## WARNING!

Do not replace original equipment tires with load ratings less than the original tires. Doing so could lead to unintentional overloading of the tire, which could cause a failure resulting in loss of vehicle control and an accident. Failure to comply may result in personal injury, death, equipment or property damage.



## NOTE

To prolong the tires' life and make them safer, have their radial and lateral run-out checked at your Kenworth Dealer. And of course have the tires balanced any time you change a tire.

## Matching Tires

Be sure to buy matched tires for your vehicle, especially on the rear axles. Mismatched tires can cause stress between axles and cause the temperature of the axle lubricant to get too hot. Matched tires will help the driveline last longer and will give you better tire mileage.



## WARNING!

Do not mismatch tires, it can be dangerous. Never mix tires of different design such as steel belted radials and bias ply tires, etc. Mixing tire types and sizes will adversely affect the road-holding ability of both types of tires and can lead to loss of vehicle control. Failure to comply may result in personal injury, death, equipment or property damage.

Make sure, too, that you use the right size tires on each wheel. Some trucks

# TIRES AND WHEEL MAINTENANCE

---

require different sizes on front and rear wheels. For safety, always use the recommended size and type of tires.

## Greenhouse Gas Certified Tires

### Replacing a tire that is greenhouse gas certified.

i	NOTE
The tires installed on this vehicle at the factory as original equipment may be certified for Greenhouse Gas and Fuel Efficiency regulations. Replacement tires must be of equal or lower rolling resistance level (TRRL or $C_{rr}$ ). Consult with your tire supplier(s) for appropriate replacement tires.	

Verify if your vehicle is equipped with Greenhouse Gas certified tires by checking the Vehicle Emission Control label on the driver's side door frame. If these tires were installed at the factory, Lower Rolling Resistance codes (LRR) identify which tires are certified.

### Maintaining a greenhouse gas certified tire.

In order to limit the rolling resistance of the tires and optimize fuel economy, the maintenance procedures specified by the tire manufacture must be followed.

For warranty information, See Greenhouse Gas Tires on page 6-9.

# TRANSMISSION MAINTENANCE

## Introduction

See the transmission manufacturer's operator's manual for lubrication specifications and service intervals.

# CLUTCH

---

## CLUTCH

### Introduction

Free pedal is the distance the clutch pedal moves by applying only slight pressure. During free pedal the release yoke in the transmission moves until its bearing pads contact the release bearing. This movement of the release yoke is called free travel. Thus, free pedal and free travel are directly related to each other.

As the clutch pedal is depressed further, with harder pressure, the release yoke moves the release bearing away from the engine. This causes the clutch plate to release from the driven disks in the clutch. This is called release travel. And finally, as the pedal is pushed to the last 1/2 to 1 inch of travel, the release bearing contacts and engages the clutch brake. This is called clutch brake squeeze. When the clutch wears, the release bearing

gradually moves toward the engine, decreasing free pedal and free travel. When all free pedal and free travel are gone, the clutch requires adjustment.

The clutch is adjusted by turning an adjustment ring that is built into the clutch. When the ring is turned, the release bearing moves back toward the transmission, restoring free pedal and clutch free travel. Under normal clutch wear this is the only adjustment needed. Do not attempt to change any other component.

### Clutch Linkage

Have your authorized Kenworth Dealer service the clutch according to the clutch manufacturer's service guidelines.

- The Kenworth is equipped with a rod and lever mechanical clutch linkage. Lubricate each pivot point on the clutch linkage.



## Clutch Adjustment - Normal Wear

See the clutch manufacturer's Service Manual for the proper adjustment procedures.



### NOTE

This procedure is all that is required for normal clutch adjustment. Adjustment of any other components is not required.

## External Linkage Adjustment

1. Adjust clutch to clutch manufacturer's specification.
2. Verify 1/8 in. free travel (distance the release yoke moves before the release yoke bearing pads contact the release bearing).
3. Verify free pedal of 1.75 in. (44 mm  $\pm$  6 mm).



**CONSUMER INFORMATION AND VEHICLE IDENTIFICATION**

Introduction . . . . . 6-3  
Reporting Safety Defects . . . . . 6-3  
Vehicle Identification . . . . . 6-4  
Certification Labels . . . . . 6-5  
Component Identification. . . . . 6-8  
How to Order Parts . . . . . 6-8

**VEHICLE EMISSIONS LIMITED EXPRESS WARRANTY**

Original Equipment Tires. . . . . 6-9  
Greenhouse Gas (GHG) Components Other Than  
Tires . . . . . 6-10  
Your Warranty Rights and Obligations . . . . . 6-10  
Manufacturer's Warranty Coverage . . . . . 6-11  
Owner's Warranty Responsibilities . . . . . 6-11  
Replacement Parts . . . . . 6-12  
PACCAR Responsibilities . . . . . 6-13  
Warranty Limitations. . . . . 6-13



# CONSUMER INFORMATION AND VEHICLE IDENTIFICATION

## Introduction



### WARNING!

This vehicle contains material known by the State of California to cause cancer and/or birth defects or other reproductive harm. This warning requirement is mandated by California law (Proposition 65) and does not result from any change in the manner in which Kenworth trucks are manufactured.

## Reporting Safety Defects

### United States

If you believe that your vehicle has a defect which could cause a crash or could cause injury or death, you should immediately inform the National Highway Traffic Safety Administration (NHTSA) in addition to notifying Kenworth Truck Company.

If NHTSA receives similar complaints, it may open an investigation, and if it finds that a safety defect exists in a group of vehicles, it may order a recall and remedy campaign. However, NHTSA cannot get involved in individual problems between you, your Kenworth Dealer, and Kenworth Truck Company.

To contact NHTSA, you may either call the Auto Safety Hotline toll-free at 1-800-424-9393 (366-0123 in Washington, D.C.) or write to:

Administrator, NHTSA, 400 Seventh Street, S.W., Washington, D.C. 20590. You can also get other information about auto safety from the Hotline.

### Canada

Canadian customers who wish to report a safety-related defect to Transport Canada, Defect Investigations and Recalls, may telephone the toll free hotline 1-800-333-0510, or contact Transport Canada by mail at: Transport Canada, ASFAD, Place de Ville Tower C, 330 Sparks Street, Ottawa ON K1A 0N5.

For additional road safety information, please visit the Road Safety website at: [www.tc.gc.ca/roadsafety](http://www.tc.gc.ca/roadsafety)

# CONSUMER INFORMATION AND VEHICLE IDENTIFICATION

## Vehicle Identification

The 17-digit Vehicle Identification Number (VIN) is used to register your vehicle for warranty, license and insurance.

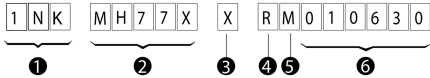

- 1 Manufacturer Identifier
- 2 Vehicle Attributes
- 3 Reserved Space
- 4 Model Year
- 5 Assembly Plant (Chassis Number)
- 6 Serial Number (Chassis Number)

Table 22 Model Year Designations

CODE	YEAR
9	2009
A	2010
B	2011
C	2012
D	2013
E	2014
F	2015
G	2016
H	2017
I	2018

## Assembly Plant Code

F = KENMEX

M = Ste. Therese

R = Renton

J = Chillicothe

# CONSUMER INFORMATION AND VEHICLE IDENTIFICATION

---

## VIN Location

The full, 17-digit VIN is exclusively located on the Weight Rating Data Label. The label is located on the driver's side door edge or on the driver's side door frame.

## Chassis Number

The Chassis Number refers to the last seven characters of the VIN. This number will allow your Kenworth Dealer to identify your vehicle. You will be asked for this number when you bring it in for service.

### Chassis Number Locations

- Right frame rail, top flange, about 3 ft. from the front end
- Cab back, left-hand rear panel, lower edge
- Tire, Rim, and Weight Rating Data label (truck)
- Components and Weights label
- Noise Emission label
- Paint Identification label

## Certification Labels

Vehicle information and specifications for your Kenworth are documented on labels. As noted below, each label contains specific information pertaining to vehicle capacities and specifications that you should be aware of.

# CONSUMER INFORMATION AND VEHICLE IDENTIFICATION

## Components and Weights Label

The Components and Chassis Weight Label is located on either the driver's side door edge or on the driver's side door frame. It includes chassis number, chassis weight and gross weight, plus model information for the vehicle, engine, transmission, and axles.

## Tire, Rim and Weight Rating Data Label

The Tire, Rim and Weight Rating Data Label is located on the driver's side door edge or on the driver's side door frame. It contains the following information:

- GVWR - Gross Vehicle Weight Rating
- GAWR FRONT, INTERMEDIATE and REAR - Gross Axle Weight Ratings for Front, Intermediate and Rear Axle
- TIRE/RIM SIZES AND INFLATION PRESSURES - Tire/Rim Sizes and Cold Pressure Minimums
- VIN including CHASSIS NUMBER

 <b>WARNING!</b>	
Do not exceed the specified load rating. Overloading can result in loss of vehicle control and personal injury, either by causing component failures or by affecting vehicle handling. Exceeding load ratings can also shorten the service life of the vehicle.	

The components of your vehicle are designed to provide satisfactory service if the vehicle is not loaded in excess of either the gross vehicle weight rating (GVWR), or the maximum front and rear gross axle weight ratings (GAWRs).

 <b>NOTE</b>	
GVW is the TOTAL SCALE WEIGHT the vehicle is designed to carry. This includes the weight of the empty vehicle, loading platform, occupants, fuel, and any load.	



## CONSUMER INFORMATION AND VEHICLE IDENTIFICATION

---

### Noise Emission Label

The Noise Emission Label is located in the driver's side door frame. It contains information regarding U.S. noise emission regulations, chassis number, and date of manufacture.

### Paint Identification Label

The Paint Identification Label contains the paint colors used by the factory to paint your vehicle. It lists frame, wheels, cab interior and exterior colors. This label is located inside the glove box.

### Federal Safety Standard Certification Label

The NHTSA regulations require a label certifying compliance with Federal Safety Standards, for United States and U.S. Territories, be affixed to each motor vehicle and prescribe where such label may be located. This certification label, which indicates the date of manufacture and other pertinent information, is located on the driver's side door edge or on the driver's side door frame.

# CONSUMER INFORMATION AND VEHICLE IDENTIFICATION

---

## Component Identification

Each of the major components on your vehicle has an identification label or tag. For easy reference, record component numbers such as, model, serial, and assembly number.

**Engine:** For further information, please refer to the Engine Operation and Maintenance Manual.

**Transmission:** For both manual and automatic transmissions, the identification number is stamped on a tag affixed to the right rear side of the transmission case.

**Clutch:** Enclosed in clutch housing. Location depends on manufacturer.

6

**Steer Axle:** The front axle serial number is stamped on a plate located on the center of the axle beam.

**Drive Axles:** The drive axle numbering system includes three labels or stamps:

1. Axle Specification Number, usually stamped on the right rear side of the axle housing. This number identifies the complete axle.
2. Axle Housing Number Tag, usually located on the left forward side of the housing arm. This tag identifies the axle housing.
3. Axle Differential Carrier Identification, usually located on the top side of the differential carrier. The following information is either stamped, or marked with a metal tag: Model No., Production Assembly No., Serial No., Gear Ratio, and Part Number.

## How to Order Parts

Replacement parts may be obtained from an authorized dealership.

When you order, it is **IMPORTANT** that you have the following information ready:

- Your name and address.
- Serial number of the truck.
- The name of the part you need.
- The name and number of the component for which the part is required.
- The quantity of parts you need.
- How you want your order shipped.

## VEHICLE EMISSIONS LIMITED EXPRESS WARRANTY

### Original Equipment Tires

PACCAR Inc warrants the tires installed as original equipment on this vehicle only against defects in materials and workmanship which cause the vehicle to fail to comply with applicable U.S. and Canadian greenhouse gas emission limits ("Warrantable Emissions Failures"). This vehicle emissions limited express warranty relating to original equipment tires is valid for two (2) years or 24,000 miles, whichever occurs first.

YOUR SOLE AND EXCLUSIVE REMEDY AGAINST PACCAR Inc IS LIMITED TO THE REPAIR OR REPLACEMENT OF ORIGINAL EQUIPMENT TIRES, SUBJECT TO PACCAR'S TIME AND MILEAGE

LIMITATIONS LISTED ABOVE. This Vehicle Emissions Limited Express Warranty relating to original equipment tires begins on the date of delivery of the vehicle to the first purchaser or lessee and accrued time and mileage is calculated when the vehicle is brought in for correction of the Warrantable Emissions Failures relating to the original equipment tires.

PACCAR MAKES NO OTHER VEHICLE EMISSIONS WARRANTIES RELATING TO THE ORIGINAL EQUIPMENT TIRES, EXPRESS OR IMPLIED. WHERE PERMITTED BY LAW, PACCAR EXPRESSLY DISCLAIMS ANY WARRANTY OF MERCHANTABILITY OR FITNESS FOR A PARTICULAR PURPOSE RELATING TO VEHICLE EMISSIONS. PACCAR AND THE SELLING DEALER SHALL NOT BE LIABLE FOR INCIDENTAL OR CONSEQUENTIAL DAMAGES INCLUDING, BUT NOT LIMITED TO: LOSS OF INCOME

OR LOST PROFITS; VEHICLE DOWNTIME; COMMUNICATION EXPENSES; LODGING AND/OR MEAL EXPENSES; FINES; APPLICABLE TAXES OR BUSINESS COSTS OR LOSSES; ATTORNEY'S FEES; AND ANY LIABILITY YOU MAY HAVE IN RESPECT TO ANY OTHER PERSON OR ENTITY RELATING TO WARRANTABLE EMISSIONS FAILURES.

**This Vehicle Emissions Limited Express Warranty relating to original equipment tires is limited to emissions compliance only.**

The tires are separately warranted by their manufacturer for defects in materials and workmanship other than those which cause non-compliance with U.S. and Canadian GHG regulations, subject to limitations and conditions contained within the tire manufacturer's warranty agreement. You are responsible for the safe operation and maintenance of the

## VEHICLE EMISSIONS LIMITED EXPRESS WARRANTY

---

vehicle and its tires. PACCAR does not warrant wear and tear of the tires.

### **Greenhouse Gas (GHG) Components Other Than Tires**

This GHG vehicle Warranty applies to the vehicle (hereafter, vehicle) certified with the US Environmental Protection Agency.

### **Your Warranty Rights and Obligations**

This vehicle is warranted for components that directly impact the manufacturer's greenhouse gas (GHG) certification with the US Environmental Protection Agency. PACCAR must warrant these components for the periods of time listed below provided there has been no abuse, neglect or improper maintenance of the vehicle.

If a GHG-related part on your vehicle is found to have a defect in material or assembly, the part will be repaired or replaced by PACCAR.

# VEHICLE EMISSIONS LIMITED EXPRESS WARRANTY

## Manufacturer's Warranty Coverage

This warranty coverage is provided for five years or 100,000 miles (160,000) km, whichever first occurs, from the date of delivery of the vehicle to the first purchaser or first lessee. Where a Warrantable Condition exists, PACCAR will diagnose and repair the vehicle, parts and labor included, at no cost to the first purchaser or first lessee and each subsequent purchaser or lessee. This warranty does not override any extended warranty purchased to cover specific vehicle components.

## Owner's Warranty Responsibilities

The vehicle owner is responsible for performing required maintenance that is listed in your engine and vehicle Operator's Manuals. The owner is responsible for presenting the vehicle to a service location as soon as a problem exists. Any warranty repairs should be completed in a reasonable amount of time.

Retain all receipts covering maintenance on this equipment. PACCAR cannot deny warranty solely for the lack of receipts or for the failure to ensure the performance of all scheduled maintenance.

PACCAR may deny warranty coverage if a vehicle component has failed due to abuse, neglect, improper maintenance, unapproved modifications (both physical components and computer

programming) or using non-Original Equipment replacement parts.

If there are any questions regarding these warranty rights and responsibilities, please contact the vehicle OEM manufacturer at the customer center telephone number provided with the vehicle operating instructions.

Prior to the expiration of the applicable warranty, Owner must give notice of any warranted failure to an authorized PACCAR dealer and deliver the vehicle to such facility for repair.

Owner is responsible for incidental costs such as: communication expenses, meals, lodging incurred by Owner or employees of Owner as a result of a Warrantable Condition.

Owner is responsible for downtime expenses, cargo damage, fines, all applicable taxes, all business costs,

## VEHICLE EMISSIONS LIMITED EXPRESS WARRANTY

---

and other losses resulting from a Warrantable Condition.

Owner is responsible for maintaining all emissions related engine and vehicle computer program settings in accordance with manufacturer specifications. This responsibility includes GHG specific settings that may not be altered before the GHG-related expiration mileage has been reached for each system.

Owner is responsible for maintaining all physical parts related to GHG-regulations in the as-built configuration and in proper working order for the full regulatory useful life of 435,000 miles for Class 8 vehicles, 185,000 miles for Class 6-7, and 110,000 for Class 5.

### Replacement Parts

PACCAR recommends that any service parts used for maintenance, repair or replacement of GHG components be new or genuine approved rebuilt parts and assemblies. The use of non-genuine engine or vehicle replacement parts that are not equivalent to the PACCAR engine or OEM vehicle manufacturer's original part specification as built from the factory may impair the engine and vehicle emissions control system from working or functioning effectively, and may jeopardize your GHG warranty coverage.

In addition, genuine vehicle or engine parts must be replaced with the same material and function as the part assembled on the vehicle from the factory.

The owner may elect to have maintenance, replacement or repair of

the emission control parts performed by a facility other than an authorized PACCAR dealer and may elect to use parts other than new or genuine approved rebuilt parts and assemblies for such maintenance, replacement or repair; however, the cost of such service or parts and subsequent failures resulting from such service or parts may not be fully warranted if the manufacturer determines that the replacement part is not of similar material and function as the OEM part assembled to the vehicle at the factory.

# VEHICLE EMISSIONS LIMITED EXPRESS WARRANTY

## PACCAR Responsibilities

The warranty coverage begins when the vehicle is delivered to the first purchaser or first lessee. Repairs and service will be performed by any authorized PACCAR dealer using new or genuine approved rebuilt parts and assemblies PACCAR will utilize replacement parts that are selected and installed to support the GHG compliance certification. PACCAR will repair parts found by PACCAR to be defective without charge for parts or labor (including diagnosis which results in determination that there has been a failure of a warranted part).

## Warranty Limitations

Sole and exclusive remedy against PACCAR and the Selling Dealer arising from the purchase and use of this vehicle is limited to the repair or replacement of "warrantable failures", for replacement parts that are similar in material and function to OEM specifications and subject to PACCAR's time, mileage, and hour limitations of the greenhouse gas warranty. The maximum time, mileage and hour limitations of the warranty begin with the Date of Delivery to the first purchaser or first lessee. The accrued time, mileage, or hours is calculated when the vehicle is brought in for correction of warrantable failures.

PACCAR is not responsible for failures or damage resulting from what PACCAR determines to be abuse, neglect or uncontrollable acts of nature, including, but not limited to: damage due to accident; operation without

adequate coolants or lubricants; overfueling; overspeeding; lack of maintenance of cooling, lubricating or intake systems; improper storage, starting, warm-up, run-in or shutdown practices; unauthorized modifications to the vehicle and its components. PACCAR is also not responsible for failures caused by incorrect oil, fuel or diesel exhaust fluid or by water, dirt or other contaminants in the fuel, oil or diesel exhaust fluid. Failure of replacement parts used in repairs due to the above non-warrantable conditions is not warrantable.

This warranty is void if the vehicle is altered with parts that do not meet the material and functional specifications as manufactured from the factory. Any alterations to vehicle or engine computer settings will void GHG warranty and potentially cause the vehicle to become non-compliant with the GHG regulation of the EPA Clean Air Act. Any alterations to

## VEHICLE EMISSIONS LIMITED EXPRESS WARRANTY

---

GHG specific settings prior to the GHG related expiration mileage for each system will void GHG warranty and potentially cause the vehicle to become non-compliant with the GHG regulation of the EPA Clean Air Act. This warranty is void if certain GHG components are not properly maintained and thus cannot perform to their designed capability.

PACCAR is not responsible for failures resulting from improper repair or the use of parts which are not genuine approved parts.

PACCAR is not responsible for the material and labor costs of emission control parts and assemblies replaced during Scheduled Maintenance of the engine as specified in PACCAR Operator's Manuals.

THIS WARRANTY, TOGETHER WITH THE EXPRESS COMMERCIAL WARRANTIES ARE THE SOLE

WARRANTIES MADE BY PACCAR IN REGARD TO THIS VEHICLE.

THIS LIMITED GHG WARRANTY IS THE SOLE WARRANTY MADE BY PACCAR AND THE SELLING DEALER. EXCEPT FOR THE ABOVE LIMITED WARRANTY, PACCAR AND THE SELLING DEALER MAKE NO OTHER WARRANTIES, EXPRESS OR IMPLIED. PACCAR AND THE SELLING DEALER EXPRESSLY DISCLAIM ANY WARRANTY OF MERCHANTABILITY OR WARRANTY OF FITNESS FOR A PARTICULAR PURPOSE.

PACCAR AND THE SELLING DEALER SHALL NOT BE LIABLE FOR INCIDENTAL OR CONSEQUENTIAL DAMAGES INCLUDING, BUT NOT LIMITED TO: LOSS OF INCOME OR LOST PROFITS; ENGINE OR VEHICLE DOWNTIME; THIRD PARTY DAMAGE, INCLUDING DAMAGE OR LOSS TO OTHER ENGINES,

VEHICLES OR PROPERTY, ATTACHMENTS, TRAILERS AND CARGO; LOSS OR DAMAGE TO PERSONAL CONTENTS; COMMUNICATION EXPENSES; LODGING AND/OR MEAL EXPENSES; FINES; APPLICABLE TAXES OR BUSINESS COSTS OR LOSSES; ATTORNEYS' FEES; AND ANY LIABILITY YOU MAY HAVE IN RESPECT TO ANY OTHER PERSON OR ENTITY.



# Index

5th wheel  
maintenance ..... 5-100

## A

About This Manual ..... 1-3

### Accessories

cigarette lighter ..... 3-6

radio ..... 3-6

Adding electrical options ..... 5-73

Additional sources of information... 1-9

installed equipment - operator's

manuals ..... 1-9

other sources ..... 1-9

Adjustable auxiliary axles ..... 4-63

liftable/non-steerable pusher

calibration ..... 4-66

liftable/steerable calibration .... 4-66

tag axle calibration ..... 4-66

Adjustments ..... 5-51

Advanced ABS with Stability

Control ..... 4-31

Air cleaner and filter ..... 5-48

Air cleaner restriction gauge ..... 5-48

Air compressor ..... 5-43

Air dryer ..... 4-18, 5-44

Air dryer (Bendix AD-IS series)... 5-45

Air dryer overhaul ..... 5-45

Air filter restriction pressure

gauge ..... 3-54

Air gauges

air filter restriction pressure .... 3-54

air pressure - air suspension air

bags #1 & #2 ..... 3-64

air pressure #1 & #2 ..... 3-62

brake application air pressure .. 3-56

pusher axle(s) air pressure ..... 3-55

tag axle air pressure ..... 3-56

tractor air brake pressure ..... 3-65

tractor air brake pressure -

primary/secondary ..... 3-63

trailer air brake pressure ..... 3-65

trailer air tank pressure ..... 3-66

Air intake system ..... 5-46

Air system

air cleaner ..... 5-48

air compressor ..... 5-43

air dryer ..... 5-44

air gauges and air leaks ..... 5-41

air intake system ..... 5-46

draining air tanks ..... 5-41

filter elements ..... 5-48

primary air pressure gauge ..... 5-41

scheduled maintenance ..... 5-39

scheduled maintenance table .. 5-39

secondary air pressure gauge . 5-41

turbocharger ..... 5-47

Air system maintenance ..... 5-38

Air tanks ..... 5-41

Alarms ..... 3-68

engine oil pressure ..... 3-21

fifth wheel slide ..... 3-22

low air warning alarm - primary 3-21

## Index

low air warning alarm -  
    secondary..... 3-21  
low coolant level..... 3-22  
park brake..... 3-21  
stop engine alarm..... 3-20  
turn signal/hazard..... 3-23  
Alert screens  
    alarm clock active..... 3-71  
    circuit failure..... 3-71  
    cruise control..... 3-71  
    cruise control rationality..... 3-69  
    DEF..... 3-70  
    disabled alert..... 3-75  
    engine over-speed shutdown low air  
    warning..... 3-72  
    engine protection shutdown  
    timer..... 3-72  
fault alert..... 3-74  
front drive axle speed warning . 3-72  
hydrocarbon burn..... 3-71  
impact alert..... 3-74  
lamp faults..... 3-69  
level 1 following distance alert . 3-74  
level 2 following distance alert . 3-73  
level 3 following distance alert . 3-73  
low voltage disconnect..... 3-70

no-idle shutdown..... 3-69  
not available alert..... 3-75  
over-crank protection..... 3-70  
park brake on while moving.... 3-69  
SCR/DEF..... 3-70  
stationary object alert..... 3-74  
trailer detect..... 3-70  
water in fuel (WIF)..... 3-71  
Wingman® ACB alert screens . 3-73  
Ammeter..... 3-54  
Analog clock..... 3-7  
Anti-lock brakes..... 4-28  
    trailer ABS (without PLC)..... 4-30  
    trailer ABS power line  
    communication..... 4-29  
Appliances..... 3-8  
Ashtray..... 3-7  
Audible alerts..... 3-17  
Automatic Traction Control.. 4-27, 4-33  
Automatic transmissions  
    auxiliary transmission..... 4-77  
    operation..... 4-76  
Auxiliary axles..... 4-63  
Axle  
    Steerable Drive Axle..... 4-77

## B

### Batteries

    battery access..... 5-78  
    battery care..... 5-81  
    battery charging..... 5-81  
    jump starting vehicles..... 2-9  
    remote keyless entry (RKE)  
    system..... 1-13  
    removing and installing  
    batteries..... 5-80  
Brake air pressure gauge..... 3-56  
Brake gauges  
    brake pedal or trailer brake hand  
    valve pressure..... 3-56  
    tractor air brake pressure..... 3-65  
    tractor primary/secondary air brake  
    pressure..... 3-63  
    trailer air brake pressure..... 3-65  
    trailer air tank pressure..... 3-66  
Brake system..... 4-17  
    advanced ABS..... 4-31  
    air supply system..... 4-18  
    anti-lock brakes..... 4-28  
    anti-lock braking system (ABS) 5-54  
    automatic (slack) adjusters..... 5-52  
    automatic traction control..... 4-33

- brake adjuster stroke..... 5-53  
 brake and slack adjuster  
   lubrication..... 5-51  
 brake component descriptions . 4-42  
 brake linings ..... 5-51  
 cam-actuated component  
   lubrication..... 5-50  
 emergency braking..... 4-26  
 engine brake..... 4-41  
 engine retarders ..... 4-39  
 exhaust brake..... 4-40  
 front brakes ..... 4-19  
 modulating valve ..... 4-19  
 overheated brakes ..... 4-26  
 parking brake system ..... 4-20  
 parking brake valve ..... 4-20  
 releasing combination of brakes 4-22  
 releasing trailer brakes..... 4-22  
 releasing truck or tractor parking  
   brakes..... 4-21  
 safety - tractor/trailer ..... 4-25  
 stability control..... 4-31  
 system park tractor..... 4-25  
 tractor/trailer air supply valve... 4-23  
 trailer brake hand valve..... 4-38  
 trailer charge..... 4-25  
 trailer emergency brake  
   application ..... 4-24  
 trailer parking brake..... 4-24  
 treadle valve - front circuit ..... 4-19  
 treadle valve - rear circuit..... 4-20  
 wet brake components..... 4-19  
 yaw control..... 4-33  
 Brake system maintenance ..... 5-49  
 Brakes  
   automatic traction control..... 4-27
- C**
- Cab and frame access ..... 1-10  
 Cab storage ..... 3-7  
   ashtray ..... 3-7  
   glove box..... 3-7  
   interior compartments..... 3-8  
 Certification labels  
   components and weights label... 6-6  
   federal safety standard certification  
     label ..... 6-7  
   noise emission label ..... 6-7  
   part identification label..... 6-7  
   tire, rim and weight rating data  
     label ..... 6-6
- Chains ..... 2-18  
 Checks and adjustments ..... 5-51  
 Cigarette lighter ..... 3-6  
 Clock  
   clock display ..... 3-81  
   clock settings menu ..... 3-82  
   lamp test ..... 3-85  
   to set alarm time..... 3-83  
   to set clock display ..... 3-82  
   to set clock home/local time... 3-82  
   to turn alarm ON/OFF..... 3-83
- Clutch  
   clutch adjustment..... 4-75  
   clutch brake ..... 4-71  
   clutch linkage ..... 5-142  
   clutch linkage adjustment..... 5-143  
   clutch linkage lubrication  
     (non-ESI)..... 5-35  
   clutch pedal shaft lubrication... 5-35  
   clutch release bearing  
     lubrication..... 5-36  
   clutch ring adjustment..... 5-142  
   clutch travel ..... 4-71  
   double clutching ..... 4-74  
   identification ..... 6-8  
   riding the clutch..... 4-74

## Index

---

Clutch maintenance ..... 5-142  
Component identification reference 6-8  
Consumer information ..... 6-3  
    how to order parts ..... 6-8  
    reporting safety defects ..... 6-3  
Controls ..... 3-6  
    indicators ..... 3-24  
Cooling system  
    adding coolant ..... 5-67  
    additives ..... 5-68  
    coolant change and refilling .... 5-69  
    engine (block) heater ..... 5-70  
    fan ..... 5-96  
    fan clutch ..... 5-96  
    radiator cap ..... 5-70  
    topping up ..... 5-65  
Cruise control ..... 4-11

## D

Daily checks ..... 1-29  
Data recorder ..... 1-7  
Daytime running light (DRL) ..... 3-98  
Differential lock (driver controlled) 4-60  
Displays/menu screens  
    clock display ..... 3-81

    clock home/local time ..... 3-82  
    clock settings menu ..... 3-82  
    diagnostic display ..... 3-80  
    fuel economy ..... 3-78  
    ignition timer ..... 3-78  
    lamp test ..... 3-85  
    left hand menu bar ..... 3-77  
    multi-function display ..... 3-75  
    multi-function menu items ..... 3-76  
    outside air temperature display 3-53  
    RPM detail ..... 3-78  
    speed control management  
        display ..... 3-81  
    to set language ..... 3-85  
    to set standard or metric units. 3-85  
    transmission display ..... 3-81  
    trip information ..... 3-79  
    trip meter ..... 3-51  
    truck information ..... 3-80  
Door lock ..... 1-11  
    key fob synchronization ..... 1-13  
    key fob troubleshooting ..... 5-84  
    remote keyless entry (RKE)  
        system ..... 1-12  
Drive axle(s) oil temperature  
    gauge ..... 3-55

Drive axles  
    identification ..... 6-8  
Driver controlled main differential  
    lock ..... 4-60  
Driver's  
    check list ..... 1-28  
    daily checks ..... 1-29  
    weekly checks ..... 1-32  
Driving tips ..... 4-5  
    coasting ..... 4-5  
    descending a grade ..... 4-6  
    economy ..... 4-6  
    engine RPM ..... 4-6  
    using the tachometer ..... 4-7  
Dual range (two-speed) rear axle 4-61

## E

Electrical and alternator  
    precautions ..... 5-84  
Electrical gauges  
    ammeter ..... 3-54  
    voltmeter ..... 3-67  
Electrical system  
    adding electrical options ..... 5-73  
    batteries ..... 5-78

- battery care ..... 5-81  
 battery charging ..... 5-81  
 electrical and alternator  
   precautions ..... 5-84  
 fuses, circuit breakers, and  
   relays ..... 5-71  
 jump starting vehicles ..... 2-9  
 removing and installing  
   batteries ..... 5-80  
 Electrical system maintenance ... 5-71  
 Electronic Stability Control  
   Indicator ..... 3-34  
 Emergency  
   battery connections ..... 2-11  
   emergency equipment kit ..... 1-28  
   jump starting vehicles ..... 2-9  
 Engine  
   drive belts ..... 5-95  
   engine fan ..... 5-96  
   engine mounting ..... 5-97  
   exhaust system ..... 5-96  
   fuel filters ..... 5-94  
   identification ..... 6-8  
   lubrication ..... 5-91  
   pipe and hose clamp torque  
     values ..... 5-93  
 Engine (block) heater ..... 5-70  
 Engine block heater ..... 4-46  
 Engine lubrication ..... 5-91  
 Engine maintenance ..... 5-90  
 Engine Mounting ..... 5-97  
 Engine operation ..... 4-44  
   cruise control ..... 4-52  
   engine block heater ..... 4-46  
   engine control display ..... 4-55  
   engine fan control ..... 4-54  
   engine idling ..... 4-51  
   engine shutdown system ..... 4-55  
   shut-down ..... 4-78  
   starting procedure - cold  
     weather ..... 4-46  
   starting procedure - normal  
     temperature ..... 4-45  
 Engine retarders ..... 4-39  
 Engine temperature gauge  
   engine (overheating) ..... 3-57  
 Engine warm-up ..... 4-47  
 Environmental Protection ..... 1-6  
 Ether metering equipment ..... 4-50
- ## F
- Fan clutch ..... 5-96  
 Fifth wheel ..... 4-14  
   air-controlled sliding ..... 4-15  
   jaw lock ..... 4-15  
   maintenance ..... 5-100  
 Frame fastener torque  
   requirements ..... 5-101  
 Freeing the vehicle from sand, mud,  
   snow and ice ..... 2-17, 2-18  
 Front axle and suspension  
   maintenance ..... 5-103  
 Fuel economy  
   driving habits ..... 4-8  
   fuel consumption ..... 4-8  
 Fuel filters  
   draining ..... 5-95  
   installing ..... 5-94  
 Fuel gauges  
   fuel filter restriction pressure ... 3-60  
   fuel tank(s) level ..... 3-61  
 Fuel shut-off valve ..... 4-80  
 Fuel specification ..... 4-80  
 Fuses, circuit breakers and relays 5-71

## Index

### G

- Gauge panel
  - A - Panel ..... 3-17
- Gauge symbols
  - air brake application pressure.. 3-48
  - air filter restriction pressure .... 3-48
  - ammeter..... 3-48
  - auxiliary transmission oil
    - temperature..... 3-50
  - diesel exhaust fluid (DEF) ..... 3-49
  - drive axle(s) oil temperature.... 3-48
  - engine coolant temperature .... 3-49
  - engine oil pressure..... 3-49
  - engine oil temperature ..... 3-49
  - fuel filter restriction pressure ... 3-49
  - fuel level (primary and secondary)..... 3-49
  - general air pressure #1 & #2 ... 3-49
  - general oil temperature ..... 3-49
  - main transmission oil
    - temperature..... 3-50
  - manifold boost pressure ..... 3-49
  - primary and secondary air pressure..... 3-50
  - pusher axles #1, #2 & #3 air pressure..... 3-48
  - suspension load air pressure, #1 & #2..... 3-50
  - symbols table ..... 3-47, 3-48
  - tag axle air pressure ..... 3-48
  - tractor brake application air pressure..... 3-50
  - trailer air tank pressure ..... 3-50
  - trailer brake application air pressure..... 3-50
  - transfer case oil temperature... 3-50
  - transmission retarder oil
    - temperature..... 3-51
  - voltmeter ..... 3-51
- Gauges
  - air filter restriction pressure .... 3-54
  - air pressure - primary ..... 3-63
  - air pressure - secondary..... 3-63
  - ammeter..... 3-54
  - auxiliary transmission oil
    - temperature..... 3-67
  - brake application air pressure.. 3-56
  - diesel exhaust fluid (DEF) ..... 3-56
  - drive axle(s) oil temperature.... 3-55
  - engine coolant (water)
    - temperature..... 3-57
  - engine hour meter..... 3-53
  - engine oil pressure ..... 3-59
  - engine oil temperature ..... 3-60
  - fuel filter restriction pressure ... 3-60
  - fuel tank(s) level ..... 3-61
  - general air pressure #1 ..... 3-62
  - general air pressure #2 ..... 3-62
  - general oil temperature ..... 3-62
  - main transmission oil
    - temperature..... 3-66
  - manifold pressure (turbo boost) 3-62
  - odometer ..... 3-51
  - primary air pressure..... 5-41
  - pusher axle(s) air pressure ..... 3-55
  - secondary air pressure ..... 5-41
  - speedometer..... 3-51
  - suspension load air pressure
    - #1..... 3-64
    - suspension load air pressure #2..... 3-64
  - tachometer..... 4-7, 3-52
  - tag axle air pressure ..... 3-56
  - tractor brake application air pressure..... 3-65
  - trailer air tank air pressure..... 3-66
  - trailer brake application air pressure..... 3-65

transfer case oil temperature... 3-66  
 transmission retarder oil  
     temperature..... 3-67  
 transmission temperature ..... 4-76  
 voltmeter ..... 3-67  
 GAWR - Gross Axle Weight  
     Rating..... 1-27  
 GCW - Gross Combination  
     Weight ..... 1-27  
 Glove box..... 3-7  
 Greenhouse Gas (GHG) Components  
     Other Than Tires..... 6-10  
 Greenhouse Gas Certification ..... 1-8  
 Greenhouse gas certified tires... 5-140  
 GVWR - Gross Vehicle Weight  
     Rating..... 1-27

**H**

Headlamps  
     halogen/hid lamp servicing ..... 5-85  
 Headlamps with Wipers  
     to activate headlamps with  
         wipers ..... 3-84  
 Headlight switch..... 3-99  
 Heater and air conditioner ..... 5-106

air conditioner..... 5-108  
     heater ..... 5-107  
 Heater and air conditioner  
     maintenance ..... 5-106  
 Heating and air conditioning  
     air flow control dial ..... 3-14  
     cab controls ..... 3-13  
     cooling..... 3-14  
     dash and floor vents ..... 3-14  
     dash vents ..... 3-14  
     defrost vents ..... 3-14  
     dehumidify ..... 3-15  
     fan control dial ..... 3-14  
     floor and defrost vents ..... 3-14  
     floor vents..... 3-14  
     fresh air mode ..... 3-14  
     fresh air/recirculation switch... 3-14  
     heating ..... 3-15  
     precautions ..... 3-10  
     recirculation switch ..... 3-14  
     temperature control dial ..... 3-14  
     what each control does ..... 3-14  
     windshield defog and defrost... 3-16  
 Hood hold downs ..... 1-14  
 Hood tilting ..... 1-14  
 How to order parts ..... 6-8

**I**

Idling the engine ..... 4-49  
 Ignition key switch ..... 3-97  
 Indicators ..... 3-24  
 Installed Equipment - Operator's  
     Manuals ..... 1-9  
 Instrument panel  
     A - Panel ..... 3-17  
     alert screens ..... 3-69  
     audible warning or alarm tone.. 3-68  
     indicator light(s) ..... 3-68  
     Multi-function message display 5-98  
     warning and information  
         screens..... 3-69  
     Wingman® ACB alert screens . 3-73  
     Wingman® ACB warning tone . 3-73  
 Instrumentation  
     A - Panel ..... 3-17  
 Interior compartments ..... 3-8

**J**

Jump starting vehicles..... 2-9

# Index

---

## K

### Keys

- Remote Keyless Entry (RKE) .. 1-11
- Kingpin Lubrication ..... 5-103
- Komfort-Latch® Feature ..... 1-22

## L

- Lap/Shoulder belt ..... 1-18
- Load distribution ..... 1-28
- Low voltage disconnect (LVD) .... 3-93
- Lubricant specifications ..... 5-33

## M

### Maintenance

- 5th wheel ..... 5-100
- air conditioner ..... 5-108
- air system ..... 5-38
- anti-lock braking system (ABS) 5-54
- brake system ..... 5-49
- chrome and aluminum surfaces 5-56
- cleaning vinyl and upholstery .. 5-60
- clutch ..... 5-142
- driver's check list ..... 1-28
- electrical system ..... 5-71

- emergency welding ..... 5-99
- engine ..... 5-90
- environmental protection ..... 5-8
- exterior ..... 5-56
- frame fastener torque
  - requirements ..... 5-101
- frame fastener torque table... 5-101
- front axle and suspension
  - lubrication ..... 5-103
- heater ..... 5-107
- inspection ..... 5-104
- introduction ..... 5-7
- lubricant specifications ..... 5-33
- lubricant specifications table ... 5-35
- maintenance schedule table
  - key ..... 5-16
- noise and emission control
  - standards ..... 5-109
- oil reservoir levels ..... 5-34
- painted surfaces ..... 5-56
- rear axle alignment ..... 5-123
- rear axle and suspension ..... 5-119
- rear axle lubrication ..... 5-122
- rear suspension fasteners torque
  - table ..... 5-121

- rear suspension U-bolt torque
  - table ..... 5-122
- recommended lubrication
  - intervals ..... 5-11
- safety precautions ..... 5-7
- safety restraint system -
  - inspection ..... 5-60
- safety restraint system - inspection
  - guidelines ..... 5-62
- sliding fifth wheel ..... 5-102
- stainless steel ..... 5-57
- steering and driveline ..... 5-124
- tail pipe surface cleaning ..... 5-57
- tire and wheel ..... 5-128
- transmission ..... 5-141
- U-bolt torque ..... 5-104
- U-bolt torque table ..... 5-105
- vehicle cleaning ..... 5-58
- washing chassis ..... 5-60
- washing exterior ..... 5-59
- wheel alignment ..... 5-104
- windshield wiper/washer ..... 5-64
- Maintenance and lubrication ..... 5-11
- Maintenance interval ..... 5-14
- Maintenance Procedures



inspection of the engine oil level 5-92  
 topping up the engine oil ..... 5-93  
 Maintenance schedule ..... 5-14  
 Maintenance schedule and lubrication  
 introduction ..... 5-10  
 Manual transmission..... 4-71  
 clutch adjustment..... 4-75  
 clutch brake ..... 4-73  
 clutch travel ..... 4-73  
 double clutching ..... 4-74  
 release bearing wear..... 4-75  
 riding the clutch..... 4-74  
 shifting gears ..... 4-73  
 Manufacturer's Warranty  
 Coverage ..... 6-11  
 Mirrors ..... 3-115  
 mirror heat button ..... 3-117  
 power mirror switch ..... 3-115  
 Multi-function display ..... 3-75  
 display panel..... 3-76  
 left hand menu bar ..... 3-77  
 left hand menu bar - menu items 3-78  
 menu items ..... 3-76  
 right hand status bar ..... 3-77

**N**

Noise and emission control  
 maintenance ..... 5-109  
 Noise control inspections ..... 5-111  
 air intake system ..... 5-111  
 blanket ..... 5-115  
 diesel particulate filters ..... 5-113  
 engine fan and shroud ..... 5-114  
 engine mounted noise  
 insulators..... 5-111  
 exhaust piping ..... 5-113  
 exhaust system..... 5-112  
 exhaust tail pipe ..... 5-114  
 hood insulation blanket ..... 5-115  
 inner fender shields and cab  
 skirt..... 5-115  
 joints and clamps..... 5-112  
 maintenance log..... 5-116  
 mufflers and exhaust tail pipe 5-113  
 shields and skirts ..... 5-116  
 transmission or driveline..... 5-114

**O**

Oil gauges

auxiliary transmission oil  
 temperature..... 3-67  
 drive axle(s) oil temperature.... 3-55  
 engine oil pressure ..... 3-59  
 engine oil temperature ..... 3-60  
 general oil temperature ..... 3-62  
 main transmission oil  
 temperature..... 3-66  
 transfer case oil temperature... 3-66  
 transmission retarder oil  
 temperature..... 3-67  
 Oil pan heater ..... 4-46  
 Operating the transmission ..... 4-70  
 cold weather warm-up ..... 4-70  
 Original Equipment Tires..... 6-9  
 Overheating engine..... 3-57  
 Owner's Warranty Coverage..... 6-11

**P**

PACCAR Responsibilities ..... 6-13  
 Painting ..... 5-100  
 Parking brake system ..... 4-20  
 Pipe and hose clamp torque  
 values..... 5-93  
 Pressure gauges

## Index

---

engine oil pressure ..... 3-59  
manifold pressure (turbo boost) 3-62  
Preventive maintenance..... 5-10  
Pusher axle(s) air pressure gauge 3-55

## R

Rear axle - dual range  
(two-speed)..... 4-61  
Rear axle and suspension  
maintenance ..... 5-119  
rear suspension fasteners ..... 5-121  
visual inspection..... 5-120  
Rear/Drive axle..... 4-57  
inter-axle differential lock ..... 4-57  
inter-axle differential lock -  
locking..... 4-59  
inter-axle differential lock -  
unlocking..... 4-59  
Recommended lubrication  
intervals..... 5-11  
Recovery ..... 2-12  
Refueling ..... 4-80  
fuel specification..... 4-80  
Remote Keyless Entry (RKE)  
batteries..... 1-13

key fob operation ..... 1-12  
key fob synchronization..... 1-13  
troubleshooting ..... 5-84  
Repairs..... 1-7  
Replacement Parts ..... 6-12  
Roll stability program (RSP) ..... 4-31

## S

Safe vehicle operation..... 1-26  
Safety  
about this manual ..... 1-3  
air suspension height/air  
pressure..... 4-12  
cab and frame access ..... 1-10  
cruise control ..... 4-11  
deflated air springs..... 4-13  
driver's check list ..... 1-28  
emergency equipment kit..... 1-28  
introduction ..... 1-3  
safe operation and driving ..... 4-10  
safe vehicle operation..... 1-26  
safety alerts..... 1-3  
suspension air pressure gauge 4-13  
vehicle loading..... 1-27  
vehicle safety ..... 1-5

Safety alerts ..... 1-3  
Safety restraint belts..... 1-17  
belt damage and repair ..... 1-24  
during pregnancy..... 1-23  
inspection ..... 5-60  
proper safety belt adjustment .. 1-18  
safety restraint tips ..... 1-24  
Seat adjustment..... 1-16  
driver's seat with air suspension 1-16  
reclining seats ..... 1-16  
standard driver's seat ..... 1-16  
Seat belts ..... 1-16  
adjustments ..... 1-16  
belt damage and repair ..... 1-24  
during pregnancy..... 1-23  
Komfort-Latch feature..... 1-22  
lap/shoulder belt..... 1-18  
proper safety belt adjustment .. 1-18  
safety restraint tips ..... 1-24  
Seats  
adjustments ..... 1-16  
Komfort-Latch feature..... 1-22  
tether adjustment..... 1-22  
tether belts ..... 1-21  
Seats and restraints ..... 1-16  
Shut-down

before stopping the engine .....	4-79	fluid level and refill .....	5-125	axle, automatic traction control	
final stopping procedures .....	4-78	steering driveline .....	5-126	switch .....	3-87
fuel specification .....	4-80	Steering column .....	3-103	back up alarm mute switch .....	3-87
introduction .....	4-78	adjustable tilt and telescoping .....	3-108	beacon light switch .....	3-89
location of fuel shut-off valves ..	4-80	trailer brake hand valve .....	3-107	brake level switch .....	3-88
refueling .....	4-80	turn signal/high beam switch ..	3-103	brake on/off switch .....	3-88
turbocharger cool down .....	4-79	Suspension lubrication .....	5-103	brake/clutch kickout power take-off	
Sliding 5th wheel		Switches		(PTO) switch .....	3-90
maintenance .....	5-102	ABS off-road switch .....	3-88	cruise control on/off switch .....	3-88
Sliding Fifth wheel		accessory air switch .....	3-89	cruise control set/resume	
maintenance .....	5-102	air conditioner switch .....	3-14	switch .....	3-88
SmartWheel control system .....	3-110	air-controlled sliding fifth wheel		cruise control switch .....	4-11
Spring brakes - manual release ..	2-15	switch .....	4-15	dash panel (dimmer) switch ...	3-100
Stability Control Indicator .....	3-34	auxiliary light switch .....	3-89	dash switches .....	3-87
Starting procedure		axle switch, diff-lock - dual .....	3-87	daytime running light switch ...	3-89
engine warm-up .....	4-47	axle switch, diff-lock - forward		deep snow and mud switch .....	4-34
ether metering .....	4-50	rear .....	3-87	diesel particulate filter (DPF)	
Starting procedure (cold weather)	4-46	axle switch, diff-lock - front .....	3-87	regeneration switch .....	3-89
Starting procedure (normal		axle switch, diff-lock - rear rear	3-87	dome light switch .....	3-89
temperature) .....	4-45	axle switch, diff-lock - single		dual range rear axle switch .....	4-61
Steer axle		rear .....	3-87	dump truck gate switch .....	3-88
identification .....	6-8	axle switch, inter axle differential		engine fan override switch .....	3-88
Steerable Drive Axle .....	4-77	locked (tandem) .....	3-87	engine fan switch .....	4-54
Steering and driveline		axle switch, pusher .....	3-91	engine heater switch .....	3-88
maintenance .....	5-124	axle switch, tag .....	3-91	engine retarder - high switch ..	3-112
driveshaft .....	5-127	axle switch, two speed .....	3-87	engine retarder - low switch ...	3-112

## Index

engine retarder - medium  
switch ..... 3-112  
engine retarder - off switch ... 3-112  
ether start switch ..... 3-88  
exhaust brake switch..... 4-40  
fifth wheel slide switch ..... 3-89  
flood light switch..... 3-89  
fog light switch..... 3-89  
forward power take-off (PTO)  
switch ..... 3-90  
forward trailer axle lift switch ... 3-91  
fresh air/recirculation switch... 3-14  
fuel heater switch..... 3-89  
hazard light switch ..... 3-90  
headlight flash switch ..... 3-114  
headlight switch ..... 3-90, 3-99  
ignition key switch..... 3-89, 3-97  
inter-axle differential lock switch 4-57  
low voltage disconnect (LVD) .. 3-87,  
3-93  
marker lamp flash switch ..... 3-114  
marker light switch ..... 3-90  
marker/clearance/cab light  
switch ..... 3-90  
marker/clearance/trailer light  
switch ..... 3-90

off-road ABS function switch ... 4-35  
panel dimmer switch ..... 3-90  
park light switch ..... 3-90  
parking brake valve ..... 3-88  
power take-off (PTO) switch... 3-90  
rear power take-off (PTO)  
switch ..... 3-90  
rear trailer axle lift switch ..... 3-91  
remote throttle switch ..... 3-88  
roofdeniser switch ..... 3-91  
shutdown switch..... 3-88  
spare switch ..... 3-89  
spot light switch ..... 3-90  
suspension air retention switch 3-91  
suspension dump switch ..... 3-91  
suspension lift switch ..... 3-91  
third axle lift switch ..... 3-91  
tow hook switch ..... 3-91  
trailer air supply valve..... 3-91  
trailer axle (3rd axle) lift switch . 3-91  
trailer belly dump switch ..... 3-92  
trailer center dump gate switch 3-92  
trailer dump gate switch ..... 3-92  
trailer front dump gate switch .. 3-92  
trailer hotline switch ..... 3-92

trailer marker light interrupter  
switch ..... 3-103  
trailer rear dump gate switch ... 3-92  
trailer suspension air dump  
switch ..... 3-92  
turn signal/high beam switch .. 3-103  
wheel differential switch ..... 4-59  
winch clutch switch..... 3-92

## T

Tag axle air pressure gauge ..... 3-56  
Temperature gauges  
drive axle(s) oil temperature... 3-55  
engine (overheating) ..... 3-57  
engine oil temperature ..... 3-60  
transmission retarder oil  
temperature..... 3-67  
water temperature (engine  
coolant) ..... 3-57  
Tether belts ..... 1-21  
Tire and wheel maintenance..... 5-128  
Tire chains..... 2-18  
Tires  
greenhouse gas certified tires . 5-140  
Tires and wheels

comparing hub-piloted and ball-seat wheels..... 5-137  
inspection and replacement ... 5-130  
matched tires ..... 5-139  
speed restricted tires ..... 5-129  
tire inflation and loading ..... 5-130  
tire replacement ..... 5-138  
wheel bearing adjustment ..... 5-135  
wheel cap nut torque  
    sequence ..... 5-134  
wheel cap nut torque table ... 5-134  
wheel mounting and fastening 5-133  
Towing ..... 2-12  
Trailer brake hand valve..... 4-38  
Trailer Detect  
    to activate trailer detect ..... 3-84  
Transmission  
    auxiliary ..... 4-77  
    identification ..... 6-8  
    maintenance ..... 5-141  
    operation ..... 4-70  
    shifting gears in a new vehicle . 4-73  
    temperature gauge ..... 4-76  
    transmission tips ..... 4-74  
    warm-up ..... 4-70  
Transmission maintenance ..... 5-141

Transmission temperature gauge 4-76  
Transmission temperature gauges  
    auxiliary transmission oil  
        temperature ..... 3-67  
    main transmission oil  
        temperature ..... 3-66  
Turbocharger ..... 5-47, 4-79

**V**

Vehicle identification  
    assembly plant code ..... 6-4  
    chassis number ..... 6-5  
    chassis number locations ..... 6-5  
    model year designations table ... 6-4  
    vehicle information and specification  
        label locations ..... 6-5  
    VIN number ..... 6-4  
    VIN number location ..... 6-5  
Vehicle loading ..... 1-27  
    GAWR ..... 1-27  
    GCW ..... 1-27  
    GVWR ..... 1-27  
    load distribution ..... 1-28  
Vehicle recovery ..... 2-12  
    recovery rigging ..... 2-14

returning vehicle to service ..... 2-14  
spring brakes ..... 2-15  
tire chains ..... 2-18  
Vehicle safety ..... 1-5  
    repairs ..... 1-7  
Vehicle/Trailer air supply valve ... 4-23  
Voltmeter ..... 3-67

**W**

Warning light/indicator symbols  
    alarm on indicator ..... 3-77  
    anti-lock brake system (ABS) .. 3-32  
    anti-lock brake system (ABS),  
        trailer ..... 3-32  
    axle, electronic stability control. 3-34  
    axle, stability control ..... 3-34  
    axle, traction control ..... 3-34  
    check transmission ..... 3-46  
    cruise control active icon ..... 3-77  
    diesel particulate filter (DPF) ... 3-35  
    dump truck, body up ..... 3-35  
    engine brakesaver or transmission  
        retarder ..... 3-36  
    engine, check engine ..... 3-36  
    engine, ether start ..... 3-36

## Index

---

- engine, fan ..... 3-38
  - engine, heater ..... 3-38
  - engine, low coolant level ..... 3-39
  - engine, overspeed ..... 3-39
  - engine, retarder (brake) ..... 3-39
  - engine, stop engine ..... 3-40
  - engine, wait to start ..... 3-40
  - fifth wheel slide ..... 3-45
  - gear display ..... 3-77
  - high exhaust system
    - temperature ..... 3-40
  - hill hold ..... 3-37
  - inter axle lock ..... 3-42
  - king pin lock ..... 3-45
  - lane departure warning (LDW) . 3-37
  - lights, high beam ..... 3-41
  - malfunction indicator lamp (MIL)..... 3-44
  - message waiting ..... 3-42
  - park brake..... 3-43
  - power take off (PTO)..... 3-41
  - pump mode ..... 3-41
  - seat belt, fasten ..... 3-43
  - service transmission ..... 3-37
  - shift indicator..... 3-77
  - trailer body up ..... 3-42
  - transmission, oil temperature
    - high ..... 3-43
  - turn signal, left ..... 3-44
  - turn signal, right ..... 3-44
  - water in fuel (WIF)..... 3-45
  - worn brake ..... 3-38
  - Warranty
    - Greenhouse Gas (GHG) Components Other Than Tires ..... 6-10
    - Limitations ..... 6-13
    - Manufacturer's warranty coverage ..... 6-11
    - Original equipment tires ..... 6-9
    - Owner's warranty coverage .... 6-11
    - PACCAR responsibilities ..... 6-13
    - Replacement parts ..... 6-12
    - Rights and obligations ..... 6-10
  - Warranty Limitations ..... 6-13
  - Warranty Rights and Obligations . 6-10
  - Weekly checks ..... 1-32
  - Welding (emergency)..... 5-99
  - What to do if..... 2-3
    - check engine lamp turns on ..... 2-5
    - engine is overheating ..... 2-5
    - engine oil pressure lamp turns on ..... 2-4
    - fuse or relay blows ..... 2-7
    - low air alarm turns on ..... 2-3
    - stop engine lamp turns on ..... 2-4
    - you need roadside assistance ... 2-3
  - Windshield wiper/washer ..... 5-64
  - Windshield wipers/washer switch ..... 3-105
- ## Y
- Yaw control ..... 4-33
  - Yaw stability ..... 4-32



Your Servicing Dealer is



Need Help? Give Us a Call - 24 Hours a Day

1-800-KW-ASSIST

(1-800-592-7747)



A **PACCAR** COMPANY

PO Box 1000  
Kirkland, Washington 98083

Printed in U.S.A.

Y53-1209-1D1