



T680
T880
W990

OPERATOR'S MANUAL

Operator's Manual
Models T680/T880/W990

Safety

1

Emergency

2

Controls

3

Driving

4

Maintenance

5

Information

6

© 2024 PACCAR Inc. - All Rights Reserved

This manual illustrates and describes the operation of features or equipment which may be either standard or optional on this vehicle. This manual may also include a description of features and equipment which are no longer available or were not ordered on this vehicle. Please disregard any illustrations or descriptions relating to features or equipment which are not on this vehicle. PACCAR reserves the right to discontinue, change specifications, or change the design of its vehicles at any time without notice and without incurring any obligation. The information contained in this manual is proprietary to PACCAR. Reproduction, in whole or in part, by any means is strictly prohibited without prior written authorization from PACCAR Inc.

Chapter 1 | SAFETY

Applies To.....	6
Using this Manual.....	7
Safety Messages and Notes.....	7
Illustrations.....	8
General Safety Instructions.....	8
Data Recorder.....	11
Environmental Protection Agency.....	11
Repairs.....	12
Additional Sources of Information.....	13
Cab Access.....	13
Deckplate Access.....	15
How to Open the Hood.....	16
Seat.....	19
Sleeper Bunks and Restraints.....	27
What to Do Before Starting the Vehicle.....	31
Vehicle Loading.....	33

Visual Inspection While Approaching the Vehicle.....	35
Daily Checks.....	35
Weekly Checks.....	37
Systems Check.....	37

1

Applies To



T680

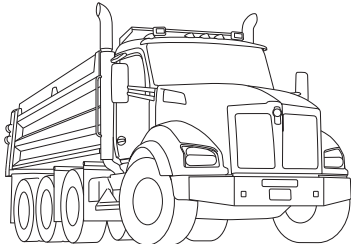
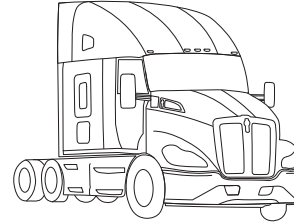

T880

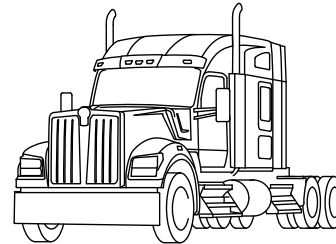

W990

Using this Manual

Please take the time to get acquainted with your vehicle by reading this Operator's Manual. We recommend that you read and understand this manual from beginning to end before you operate this equipment. This manual contains useful information for the safe and efficient operation of this equipment. It also provides maintenance information, with an outline for performing safety checks and basic preventive maintenance inspections. When replacement parts are needed, we recommend using only genuine PACCAR parts.

We have tried to present the information needed to learn about functions, controls, and operation—and to present it as clearly as possible. Occasionally, you may need to reference this manual, and we hope you find it easy to use.

	NOTE
After you have read this manual, it should be stored in the cab for con-	

venient reference and remain with this vehicle when sold.

Your vehicle may not have all the features or options mentioned in this manual. Therefore, you should pay careful attention to the instructions that pertain to just your vehicle. In addition, if your vehicle is equipped with special equipment or options not discussed in this manual, consult your dealer or the manufacturer of the equipment.

There are several tools built into this manual to help you find what you need quickly and easily; first is the Table of Contents. Located at the front of the manual, this table arranges the subject matter into chapters, which can be quickly referenced using the numbers shown in the outer margin. The first page of each chapter presents a list of the major subjects contained in that chapter. Cross-referenced citations can also help you find information. If more information on the current subject is located elsewhere in the manual, a cross-reference may be provided, such as "see [Safety Messages and Notes](#) on page 7." Finally, you will find a helpful index at the back of the manual which lists the subjects covered alphabetically.

All information contained in this manual is based on the latest production information available at the time of publication. If you find differences between your instruments and the information in this manual, contact an authorized Kenworth dealer. Kenworth Truck Company reserves the right to make changes at any time without notice.

Safety Messages and Notes

Read and follow ALL safety messages in this manual. When followed, injury to yourself and others, damage to equipment and/or property, or other unknown hazards are reduced. Both safety messages and notes are emphasized using a safety message symbol and one of three signal words: WARNING, CAUTION, or NOTE. **Do not** ignore any of these messages.

Warnings



Safety messages that follow this symbol and signal word provide a warning concerning operating procedures, actions, or a lack of action that could result in death

or injury. An unheeded warning may also result in damage to equipment, property, or the environment. Warning messages will identify the hazard, how to avoid it, and the probable consequence of not avoiding the hazard.

Example:



WARNING

DO NOT change hot engine oil as you could be burned. Let the engine cool down before changing the engine oil. Failure to comply may result in death, personal injury, equipment damage, or property damage.

Cautions



Safety messages that follow this symbol and signal word provide a caution against operating procedures, actions, or a lack of action that could result in equipment, property, or environmental damage. Caution messages will identify the hazard, how to avoid it, and the probable consequence of not avoiding the hazard.

Example:



CAUTION

DO NOT operate your vehicle with insufficient oil pressure as this will cause serious engine damage. Failure to comply may result in equipment or property damage.

Notes



Messages that follow this symbol and signal word provide important information that, while not safety related, should still be followed. A note will provide information that may be useful to the reader: clarifying the topic, providing valuable insight into the topic or process, or saving the reader time and effort.

Example:



NOTE

Pumping the accelerator pedal will not assist in starting the engine.

Illustrations

Some of the illustrations found in this manual are generic. They will not look exactly like the parts or assemblies you find installed on the vehicle.

When an illustration differs from what you see physically present on the vehicle, the language describing the procedure is still correct for the application.

General Safety Instructions



WARNING

Improper practices, carelessness, or ignoring safety messages – Warnings and Cautions – may cause death, personal injury, or equipment and property damage.

Before performing any repair, read and understand all of the safety precautions and warnings. The following is a list of general safety precautions that must be followed to provide personal safety. Failure to follow these instructions may cause

death or injury. Special safety precautions are included in the procedures when they apply.

Keep in mind that even a well-maintained vehicle must be operated within the range of its mechanical capabilities and the limits of its load ratings. See the Weight Ratings label on the driver's door edge.

Every new vehicle is designed to conform to all Federal Motor Vehicle Safety Standards applicable at the time of manufacture. Even with these safety features, continued safe and reliable operation depends upon regular vehicle maintenance. Follow the maintenance recommendations found in the Maintenance section. Following maintenance recommendations will help your vehicle maintain quality conditions. Make sure your vehicle is in top working condition before heading out on the road, it is the driver's duty to do so. Inspect the vehicle according to the Driver's Check List:

- Work areas should be dry, well lit, well ventilated; free from clutter, loose tools, parts, ignition sources, and hazardous substances.
- Wear protective glasses and protective shoes when working.

- Wear protective gloves when working with hot liquids or surfaces, and when working with components that have sharp edges.
- DO NOT wear loose-fitting or torn clothing. Tie back and/or tuck in long hair. Remove all jewelry when working.
- Before beginning any repair, disconnect the battery (negative [-] cable) and discharge any capacitors.
- Put a "DO NOT OPERATE" tag in the operator's compartment or on the controls.
- Allow the engine to cool before slowly loosening the coolant fill cap to relieve the pressure from the cooling system.

 **WARNING**

Removing the fill cap on a hot engine can cause scalding coolant to spray out and burn you badly. If the engine has been in operation within the previous 30 minutes, be very careful in removing the fill cap. Protect face, hands, and arms against escaping flu-

id and steam by covering the cap with a large, thick rag. DO NOT try to remove it until the surge tank cools down or if you see any steam or coolant escaping. Always remove the cap very slowly and carefully. Be ready to back off if any steam or coolant begins to escape. Failure to comply may result in death, personal injury, equipment or property damage.

 **WARNING**

DO NOT attempt to service the high-pressure fuel system unless you are a certified technician. Escaping high-pressure fuel is dangerous. Failure to comply may result in death or personal injury.

- Always use wheel chocks or proper jack stands to support the vehicle or vehicle components before performing any service work. DO NOT work on anything that is supported only by lifting jacks or a hoist. Before resting a vehicle on jack stands, be sure the stands are rated for the load you will be placing on them.

- Before loosening or disconnecting lines, fittings, or related items, always release line pressure in the system. Make sure to use the approved system point and method for the specific system (fuel, oil). Escaping high-pressure fluids can cause severe injury. PACCAR does not provide the approved system points and methods in *operator's* manuals. The service literature provides this information. You can obtain service literature through a certified service center.
- Always wear protective clothing when working on any refrigerant lines and make sure that the workplace is well ventilated. Inhalation of fumes can cause death or personal injury. To protect the environment, liquid refrigerant systems must be properly emptied and filled using equipment that prevents the release of refrigerant gas. Federal law requires capturing and recycling refrigerant.
- When moving or lifting any heavy equipment or parts, make sure to use proper techniques and assistance. Ensure all lifting devices such as chains, hooks, or slings are in good condition and are rated for the correct load capacity. Make sure all lifting devices are positioned correctly.
- Corrosion inhibitors and lubricating oils may contain alkali. DO NOT get the substance in eyes and avoid prolonged or repeated contact with skin. DO NOT swallow. If ingested, seek immediate medical attention. DO NOT induce vomiting. In case of contact, immediately wash skin with soap and water. In case of harmful contact, immediately contact a physician. Always keep any chemicals OUT OF REACH OF CHILDREN.
- When working on the vehicle, be alert for hot parts on systems that have just been turned off, exhaust gas flow, and hot fluids in lines, tubes, and compartments. Contact with any hot surface may cause burns.
- Always use tools that are in good condition. Make sure you have the proper understanding of how to use the tools before performing any service work. Use only genuine replacement parts from PACCAR.
- Always use the same fastener part number (or equivalent) when replacing items. DO NOT use a fastener of lesser quality if replacements are necessary. (e.g., DO NOT replace a Metric 10.9 grade with 8.8 grade fastener).
- Always torque fasteners and fuel connections to the required specifications. Overtightening or under-tightening can allow leakage.
- Close the manual fuel valves prior to performing maintenance and repairs, and when storing the vehicle inside.
- DO NOT perform any repair when impaired, tired, fatigued, or after consuming alcohol or drugs that can impair your functioning.
- Some state and federal agencies in the United States of America have determined that used engine oil can be carcinogenic and can cause reproductive toxicity. Avoid inhalation of vapors, ingestion, and prolonged contact with used engine oil.
- Coolant is toxic. If not reused, dispose of coolant in accordance

with local environmental regulations.

 CAUTION
<p>Corrosive chemicals can damage the engine. DO NOT use corrosive chemicals on the engine. Failure to comply may result in equipment or property damage.</p>

California Proposition 65 Warning

- Diesel engine exhaust and some of its constituents are known to the State of California to cause cancer, birth defects, and other reproductive harm.
- The catalyst substrate located in the Diesel Particulate Filter (DPF) contains vanadium pentoxide, which has been determined by the State of California to cause cancer. Always wear protective clothing and eye protection when handling the catalyst assembly. Dispose of the catalyst in accordance with local regulations. If catalyst material gets into the eyes, immediately flood eyes with water for a minimum of 15 minutes. Avoid

prolonged contact with skin. In case of contact, immediately wash skin with soap and water. In case of harmful contact, immediately contact a physician.

- Other chemicals in this vehicle are also known to the State of California to cause cancer, birth defects, or other reproductive harm.
- Battery posts, terminals, and related accessories contain lead and lead compounds, chemicals known to the State of California to cause cancer and reproductive harm. Wash hands after handling.

Data Recorder

California Vehicle Code - Section 9951 - Disclosure of Recording Device
Your vehicle may be equipped with one or more recording devices commonly referred to as "event data recorders" (EDR) or "sensing and diagnostic modules" (SDM). If you are involved in an accident, the device(s) may have the ability to record vehicle data that occurred just prior to and/or during the accident. For additional

information on your rights associated with the use of this data, contact:

- The California Department of Motor Vehicles - Licensing Operations Division
- <http://www.dmv.ca.gov/>

Environmental Protection Agency

Some of the ingredients in engine oil, hydraulic oil, transmission and axle oil, engine coolant, diesel fuel, air conditioning refrigerant (R12, R134a, and PAG oil), batteries, etc., may contaminate the environment if spilled or not disposed of properly.

**WARNING**

Diesel engine exhaust and some of its constituents are known to the State of California to cause cancer, birth defects, and other reproductive harm. Other chemicals in this vehicle are also known to the State of California to cause cancer, birth defects or other reproductive harm. This warning requirement is mandated by California law (Proposition 65) and does not result from any change in the manner in which vehicles are manufactured.

**WARNING**

Diesel and gasoline engine exhaust and some of their constituents are known to the State of California to cause cancer, birth defects, and other reproductive harm. Other chemicals in this vehicle are also known to the State of California to cause cancer, birth defects or other reproductive harm. This warning requirement is mandated by California law (Proposition 65) and does not result from any

change in the manner in which vehicles are manufactured

Contact your local government agency for information concerning proper disposal.

Repairs**WARNING**

DO NOT attempt maintenance or repair work without sufficient training, proper tools, and up-to-date service instructions. Perform only those tasks you are fully qualified to do. Failure to comply could place personnel at risk or make the vehicle unsafe, which may result in death, personal injury, equipment damage or property damage.

**WARNING**

Modifying your vehicle can make it unsafe. Some modifications can affect your vehicle's electrical system, stability control system, or other important functions. Before modifying your vehicle, check with your dealer to make

sure it can be done safely. Failure to comply may result in death, personal injury, equipment damage, or property damage.

**CAUTION**

The installation of electronic devices to the On-board Diagnostics (OBD) connector, the vehicle Controller Area Network (CAN), or their associated wiring is not permitted. Doing so can adversely affect vehicle performance and/or cause fault codes to be recorded. The OBD connector is provided for temporary connection of service tools and for diagnostic purposes only.

Your dealer's service center is the best place to have your vehicle repaired. You can find dealers all over the country with the equipment and trained personnel to get you back on the road quickly—and keep you there.

Your vehicle is a complex machine. Anyone attempting repairs on it needs proper mechanical training and the proper tools. However, all warranty repairs must be performed by an authorized service

facility. If you are not an experienced technician, or do not have the right equipment, please leave all repairs to an authorized service facility. They are the ones best equipped to do the job safely and correctly.

Maintenance Manuals

If you do decide to do any complex repair work, you will need the maintenance manuals. Order them from your authorized dealer. Please provide your Chassis Serial Number when you order, to be sure you get the correct manuals for your vehicle. Allow about four weeks for delivery. There will be a charge for these manuals.

Final Chassis Bill of Material

A complete, non-illustrated computer printout listing of the parts used to custom-build your vehicle is available through the dealer from whom you purchased your vehicle.

Additional Sources of Information

Major component suppliers also supply operation manuals specific to their products. The glove box contains these manuals and other pieces of literature. Look for information on products such as the engine, driver's seat, transmission, axles, wheels, tires, antilock braking system and electronic stability control (ABS/ESC), radio, fifth wheel, lane departure, and adaptive cruise control. If you are missing these pieces of literature, ask your dealer for copies.

Another place to learn more about trucking is from local truck driving schools. Contact one near you to learn about the courses they offer. Federal and state agencies, such as the Department of Licensing, also have information.

Cab Access



WARNING

Always reinstall steps before entering the cab or accessing the deck plate.

Without steps you could slip and fall. Failure to comply may result in death or personal injury.



WARNING

Clean any fuel, oil, or grease off of vehicle steps and handles before entering, exiting, or climbing onto the vehicle. Keep vehicle steps and handles clean! Failure to comply may lead to a slip or fall resulting in death, personal injury, equipment damage, or property damage.



WARNING

Use care when entering, exiting, or climbing onto the vehicle when the steps, handholds, or footwear are wet, muddy, or coated with ice or snow. Failure to comply may lead to a slip or fall resulting in death, personal injury, equipment damage, or property damage.

**WARNING**

Always face toward the vehicle and DO NOT jump when entering or exiting the cab. Use the steps, handles, and anti-skid surfaces provided instead of components not designed for entry or exit. Always maintain at least three points of contact between your hands, feet, and the vehicle. Failure to comply may lead to a slip or fall resulting in death, personal injury, equipment damage, or property damage.

Be careful whenever you get into or out of the vehicle's cab. Always maintain at least three points of contact with the vehicle when entering or exiting. The placement of hands on the grab handles and feet on the steps meet this requirement. The following shows the best way to enter and exit the cab:



How to Lock and Unlock the Cab Doors

The vehicle has one key for cab doors, ignition, and the optional sleeper luggage compartment. Frame-mounted tool box locks and locking fuel tank caps each have separate, individual keys.

**WARNING**

In case of an accident, to reduce the possibility of personal injury or death, always lock the doors before driving the vehicle. Along with using the lap shoulder belts properly, locking the doors helps prevent doors from inad-

vertently opening and occupants from being ejected from the vehicle. Failure to comply may result in death, personal injury, equipment damage, or property damage..

To lock or unlock the doors from outside the cab:

- To lock, rotate the key toward the rear of the vehicle (clockwise).
- To unlock, rotate the key toward the front of the vehicle (counter clockwise).

Remote Keyless Entry (Option)

Remote Keyless Entry (RKE) is a system that adds security and convenience to your vehicle. The system will lock or unlock cab doors with the key fob. The system will alert you with parking lights when the selected doors are locked or unlocked. The system includes two key fobs that provide secure rolling code technology that prevents someone from recording the entry signal.

i NOTE

FCC ID: L2C0031T IC: 3432A-0031T
 FCC ID: L2C0032R IC: 3432A-0032R
 This device complies with Part 15 of the FCC Rules and with RSS-210 of Industry Canada. Operation is subject to the following two conditions (1) This device may not cause harmful interference, and (2) This device must accept any interference received, including interference that may cause undesired operation. Changes or modifications not expressly approved by the party responsible for compliance could void the user's authority to operate the equipment. The term IC: before the radio certification number only signifies that Industry Canada technical specifications were met.

Operate Door Locks using Remote Keyless Entry

Open doors will not lock using the key fob. The key fob should be within 30 ft. (9 m) of the vehicle and should not be in proximity of other radio frequency sources such as television, radio, or cell phone transmitters.

To unlock the cab doors:

1. Press the **UNLOCK** button once. The driver's door will unlock and the parking lights will come on for 40 seconds.
2. Quickly press the **UNLOCK** button a second time within 5 seconds to unlock the passenger door.
3. Press the **LOCK** button. The doors will lock and the parking lights will come on for 2 seconds.

Deckplate Access

! WARNING

Always reinstall steps before entering the cab or accessing the deck plate. Without steps you could slip and fall. Failure to comply may result in death or personal injury.

! WARNING

Clean any fuel, oil, or grease off of vehicle steps and handles before entering, exiting, or climbing onto the vehicle. Keep vehicle steps and handles

clean! Failure to comply may lead to a slip or fall resulting in death, personal injury, equipment damage, or property damage.

! WARNING

When you are climbing onto and off the deckplate, maintain at least three points of contact with your hands on the grab handles and your feet on the steps. Always face toward the vehicle when entering or exiting the cab and look where you are going. Failure to comply may result in death or personal injury.

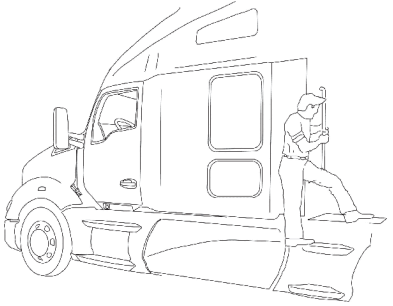

1

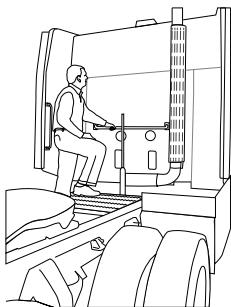
**WARNING**

When stepping onto a surface to enter the cab or access the deckplate, only use the steps and grab handles installed and designed for that purpose. Failure to use the proper steps and grab handles could cause a fall which may result in death or personal injury.

**NOTE**

Any alteration (adding bulkheads, headache racks, tool boxes, etc.) behind the cab that affects the utilization

of installed grab handles, deckplates, or frame access steps should comply with Federal Motor Carrier Safety Regulation 399.

How to Open the Hood**WARNING**

Always open the hood with both feet planted firmly on the ground and one or both hands on the hood. If you lose your footing, the hood may open or close uncontrollably. Failure to comply may result in death, personal injury, equipment damage, or property damage.

**WARNING**

Always ensure the hood lock has engaged whenever the hood is opened. Failure to lock the hood open may result in the hood closing uncontrollably, which may result in death, personal in-

jury, equipment damage, or property damage.

**WARNING**

Be sure to latch the hood securely. A hood not latched securely could open during operation and cause vehicle damage. Failure to comply may result in death, personal injury, equipment damage, or property damage.

Access the engine by opening the hood. The hood is held in the closed position by two latches called hold-downs. The hold-downs are mounted on either side of the vehicle hood.

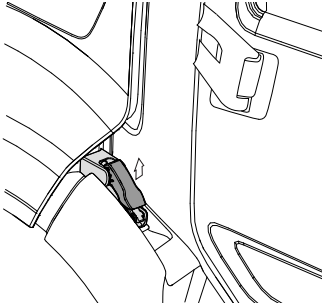

1. Release the hood hold-downs.

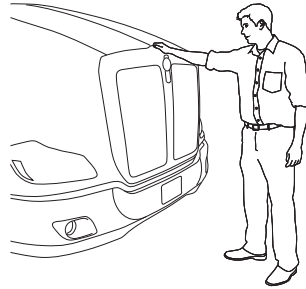

*Tilt hood forward until it stops.
When fully opened, the hood lock
engages automatically.*

Ensure hood lock is engaged.¹

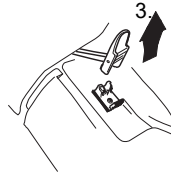
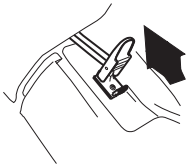

2. Place one or both hands at top of hood front, and tilt hood forward by pulling hood. Keep both feet on the ground for stability.

Hood Lock

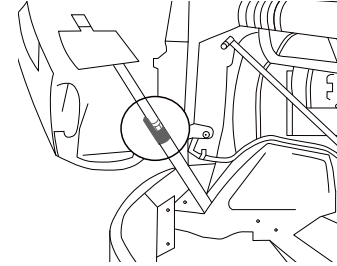

Hood Lock - Engaged

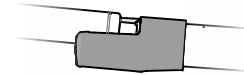

Hood Lock - NOT Engaged

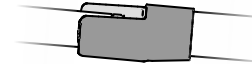

¹ When hood lock is engaged, the strut is visible above the lock.

A hood that closes uncontrollably may result in personal injury.

Close the Hood



WARNING

Before closing the hood, ensure no objects are in the way. Close the hood in a controlled manner and **DO NOT** let go with hands firmly grasping the hood and feet on a stable, non-slip surface. Failure to comply may result in death, personal injury, equipment damage, or property damage.



WARNING

Before closing the hood, be sure the area is clear—no people or objects are in the way. Failure to do so may result in death or personal injury.

The hood lock will only be engaged if the vehicle hood is fully open. Once it is fully open, the latch will automatically engage and will need to be disengaged by the operator. The release lever for the hood

lock is located near the front hinge of the hood.

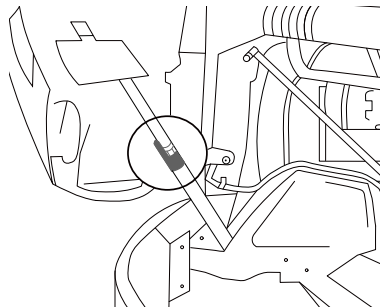

To disengage the hood lock, press the collar toward the strut until a snap is felt and the collar surrounds the strut bar. When the hood lock is disengaged, the strut will no longer be visible above the hood lock collar.

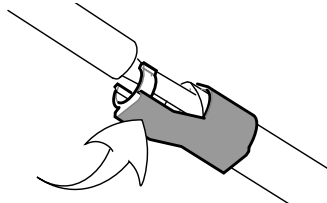

When closing the hood, be sure that you maintain the same point of contact (top of hood) to control the movement of the hood

as it closes. Gently lower the hood into place to avoid damage to the hood or cab.

Under Hood Air Intake (Option)

The optional under hood intake switch allows the operator to use air from under the hood in the event the air filter housing's inlet is blocked by snow or ice.



WARNING

DO NOT open the under hood air door with hands. This door is held closed with a spring which may pull the door closed unexpectedly. Failure to comply may result in death, personal injury, equipment damage, or property damage.



CAUTION

Only operate the under hood intake air switch when outside temperatures are below 32°F (0°C). Engaging the under hood air intake while temperatures are above freezing may result in engine damage.

The switch is directly wired to a solenoid on the air filter housing. This air solenoid (normally closed) will engage when signaled which will supply air to a piston. This air pressure will overcome a spring which holds a door closed inside the air filter housing. Fully engaged, the door will open and air will enter from under the hood instead of the opening on the side of the hood.

Seat

This seat has up to ten different controls that maximize the driver's comfort. Lumbar (and bolster support if available) are provided for superior support to the back during operation. Lower support is standard and the optional functions include upper lumbar and bolster functions. Pressing on the "+" symbol of the button will add support in the area. Pressing the opposite side of the button releases pressure and will reduce support in the area.

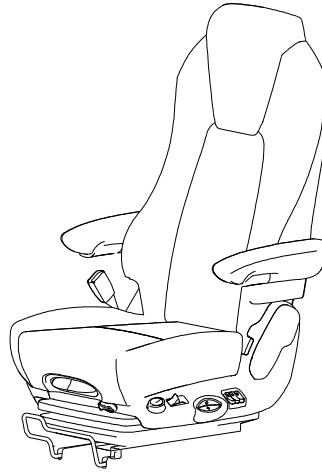

The seats in this vehicle are equipped with a switch that locks out the fore-aft isolator function in the seat. When locked, the seat will not move back and forth. It is rigidly fixed and only allowed to move up and down with the vehicle's movements. This vehicle may be equipped with a swivel function on the passenger seat. This function allows the passenger seat to rotate and face toward the inside of the cab.



WARNING

Always make sure that the passenger seat is locked into the forward facing position when the vehicle is in motion. Locking the swivel seat into the forward-facing position maximizes visibility to the surrounding area. Failure to comply may result in death or personal injury.



WARNING

DO NOT use the seat swivel function while a passenger is in the seat and the vehicle is in motion. The seat belt will not provide proper protection if the passenger seat is not locked facing forward and the vehicle is in an accident. Failure to comply may result in death or personal injury.

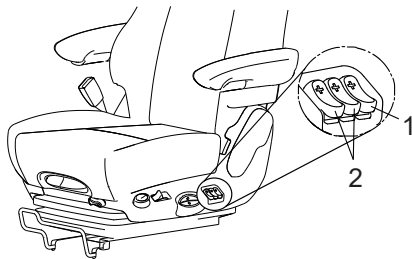

1. Bolster adjustment (option)
2. Lower and upper lumbar adjustment

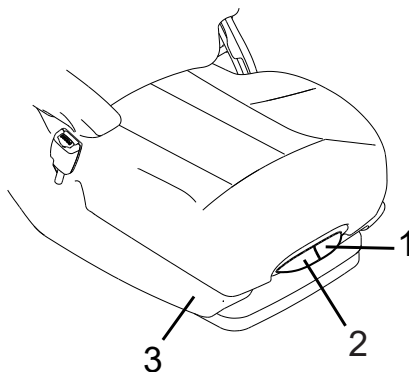

1. Seat bottom angle adjustment
2. Seat thigh support up/down
3. Seat heater/cooler

**WARNING**

This seat may be equipped with a seat heater or ventilation system. There is a possibility that some people may suffer heat-induced burns or excessive cooling when using the system. **DO NOT**

use either of these systems if you have a diminished ability to sense temperature, a reduced ability to feel pain, or have sensitive skin.

**WARNING**

When using the seat heater or ventilation system, **DO NOT** place anything on the seat such as a blanket, cushion, or similar items. Objects placed between the occupant and the seat cushion may cause the seat heater or ventilation system to overheat, which may injure the seat occupant or may damage the seat.

**CAUTION**

DO NOT use the seat heater for more than 10 minutes at a time. Always switch off the seat heaters when they are not needed. Overuse of the seat heater may drain the vehicle's low-voltage batteries. Failure to comply may result in equipment damage or property damage..

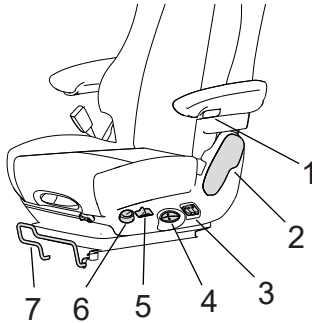

1. Armrest angle
2. Recline
3. Lumbar and bolster (bolster is an optional feature)
4. Seat height
5. Suspension stiffness
6. Express down
7. Seat fore-aft

**WARNING**

DO NOT drive or ride with your seat back in the reclined position. You could be injured by sliding under the

seat belts in a collision. Failure to comply may result in personal injury or death.

Passenger Seat Swivel (Option)

This vehicle may be equipped with a swivel function on the passenger seat. This function allows the passenger seat to rotate and face towards the inside of the cab.

**WARNING**

Always make sure that the passenger seat is locked into the forward facing position when the vehicle is in motion. Locking the swivel seat into the forward-facing position maximizes visibility to the surrounding area. Failure to comply may result in death or personal injury.

**WARNING**

DO NOT use the seat swivel function while a passenger is in the seat and the vehicle is in motion. The seat belt will not provide proper protection if the

passenger seat is not locked facing forward and the vehicle is in an accident. Failure to comply may result in death or personal injury.

How to adjust a seat**WARNING**

DO NOT adjust the driver's seat while the vehicle is moving. The seat could move suddenly and unexpectedly and can cause the driver to lose control of the vehicle. Make all adjustments to the seat while the vehicle is stopped. After adjusting the seat and before driving off, always check to ensure that the seat is firmly latched in position. Failure to comply may result in property damage, personal injury, or death.

**WARNING**

Before driving or riding in vehicle, ensure that there is adequate head clearance at maximum upward travel of seat. Injury may occur if head clearance is not adequate. Failure to comply may result in personal injury or death.

1. Set the seat's fore/aft position via the bar located below the seat cushion. This is a mechanical latch that does not involve any electric or air operated devices to control adjustment.
2. Set the seat height via the large switch on the left side of the seat cushion. This switch is located in the center of the seat pad and uses air to adjust the seat height.
3. Adjust the thigh support by toggling the switch located immediately under the seat bottom cushion and above the fore/aft position adjustment lever.
4. Adjust the seat bottom angle using the switch next to the thigh support.

5. Adjust the seat back recline angle using the large lever situated near the seat belt buckle.
6. Adjust the lumbar support by using the switch bank located on the side the seat cushion between the up/down adjustment switch and the seat recline adjustment lever.
7. Adjust the steering wheel.
8. Adjust the cab side mirrors.

Seat Belts

Seat belts have a locking mechanism. This mechanism adjusts automatically to a person's size and movements as long as the pull on the belt is slow. Hard braking or a collision locks the belt. The belt locks when driving up or down a steep hill or in a sharp curve.

Unbelted occupants may be ejected from the cab, strike other cab occupants, and sustain more severe injuries in an accident. Always observe user warnings pertaining to seat belts. The vehicle has a seat belt indicator lamp located on the dash.

**WARNING**

DO NOT drive the vehicle without your seat belt and any passengers' belts properly fastened. Failure to comply may result in death or personal injury.

**WARNING**

DO NOT use the seat swivel function while a passenger is in the seat and the vehicle is in motion. The seat belt will not provide proper protection if the passenger seat is not locked facing forward and the vehicle is in an accident. Failure to comply may result in death or personal injury.

**WARNING**

A safety restraint's metal tongue may become a striking object during sudden stops or crashes. When not in use, make sure each seat belt is fully wound up on its retractor and properly stowed. Failure to comply may result in death, personal injury, equipment or property damage.

**WARNING**

DO NOT modify or disassemble the safety restraints in your vehicle. They will not be able to keep you and your passengers safe. Failure to comply may result in death or personal injury.

Correct Seat Belt Use**NOTE**

Responsible operators make sure that all vehicle passengers ride safely. The operator is responsible for informing passengers and co-drivers how to

properly use all available safety restraints while in the vehicle.

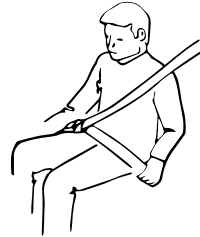
Correct Placement of Lap Belt**Correct Placement of Shoulder Belt****Incorrect Seat Belt Use****WARNING**

DO NOT strap in more than one person with each seat belt. Failure to comply may result in death, personal injury, equipment or property damage.

**WARNING**

DO NOT wear a seat belt over rigid or breakable objects (such as eyeglasses, pens, keys, etc.). Failure to comply may result in death, personal injury, equipment or property damage.

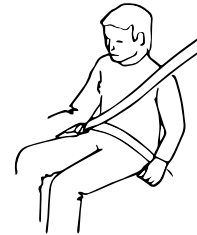
Lap Belt Too High on the Hip

1

Shoulder Belt Incorrectly Under the Arm**Seat Belt Twisted**

The lap belt portion must be worn snugly and as low as possible across the pelvis. To avoid pressure on the abdomen, the belt must never pass over the waist. A properly worn seat belt significantly reduces the risk of injury to a woman or baby in a crash.

**Safety Restraint Cleaning**

All safety restraints must be kept clean or the retractors may not work properly. Clean the safety restraints by following the care label on the belts. Let them dry completely before allowing them to retract or be stowed away.

**WARNING**

DO NOT use bleach or dye to clean a safety restraint. Chemicals can make safety restraint components weak and unsafe for vehicle operation. Failure to comply may result in death or personal injury.

How to Use a Seat Belt

Follow these steps to fasten the seat belt. Make sure that all other occupants do the same.

**WARNING**

Make sure that each passenger wears and adjusts their seat belt before vehicle operation to maximize occupant safety. Failure to comply may result in death or personal injury.

To fasten the belt:

1. Grasp the belt latch.
2. Pull the belt in a continuous slow motion across the chest and lap.

Seat Belt Use During Pregnancy**WARNING**

Pregnant women should always wear seat belts in the proper position to reduce the risk of harm in the event of a crash. Failure to comply may result in death or personal injury.

3. Insert the belt latch plate into the buckle on the inboard side of the seat.

**NOTE**

Make sure there are no obstructions in or on the buckle that could prevent secure safety restraint locking.

Push down until the latch is securely locked with an audible click.

5. Pull the belt to check for proper fastening and adjustment.
 - a. Pull the shoulder belt to make sure that the belt fits snugly across the chest and pelvis.
 - b. There must be less than one inch (in) (25 mm) gap between the body and the belt.
 - c. Position the shoulder restraint over the shoulder. Never allow a shoulder belt to rest against the neck. Never wear the belt under the arm.
 - d. Make sure that any slack is wound up on the retractor.

Make sure that the belt is not twisted.

If the belt is locked, lean back to remove any tension in the belt. After releasing the belt, allow the belt to retract completely. Guide the belt latch until the belt comes to a stop. To unfasten the belt, push the release button on the buckle. The seat belt indicator lamp switches on when the driver's seat belt is unfastened.

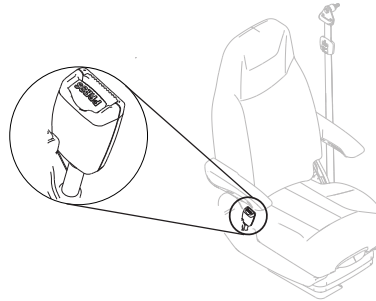
**Tether Belts****WARNING**

DO NOT remove, modify, or replace the tether belt system with a different tether system. A failed or missing tether belt could allow the seat base to fully extend in the event of an accident. Failure to comply may result in death or personal injury.

**WARNING**

Failure to adjust external tether belts properly can cause excessive movement of the seat in an accident. Tether belts should be adjusted so that they are taut when the seat is in its most upward and forward position. Failure to comply may result in death or personal injury.

Make sure that the tether belt is attached to the cab floor and seat frame. It should be routed through the buckle on each side. Often the attachments are made using a split-type hook. Make sure both halves of the hook are around the anchor bracket.

1

Adjust an external tether by either lengthening or shortening the strap. To lengthen it:

1. Turn the buckle to a right angle to the webbing.
2. Then pull the buckle.
3. To shorten the tether, pull on the strap.

Komfort Latch Feature

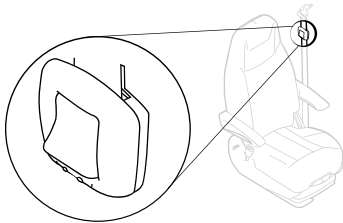

WARNING

DO NOT set the Komfort Latch with too much slack. Too much slack may reduce the effectiveness of the seat

belt. Failure to comply may result in death or personal injury.

To eliminate cinching, simply activate the Komfort Latch device located on the seat belt webbing at the appropriate time:

1. Adjust the seat to its proper driving position.
2. Latch the seat belt.
3. If available, adjust the seat belt height adjuster to a comfortable driving position.
4. While seated appropriately, push the "on" button to engage the Komfort Latch.
5. Learn forward in the seat until you hear a "click."
6. Return to normal driving position, and the Komfort Latch maintains the preset amount of tension relief.

More information and video tutorials can be found at: <https://www.imminet.com/resources/click-tug-slug/>

To disengage the mechanism unbuckle the seat belt and then press the **OFF** button of the Komfort Latch or tug on the shoulder strap.



Safety Restraint Maintenance



WARNING

Safety restraints can be damaged on all part of the assembly (such as webbing, bindings, buckles, or retractors) during everyday use. Since damaged or worn safety restraints may not protect the wearer, if the restraint shows any signs of damage or wear it must be replaced. Failure to comply may result in death, personal injury, equipment or property damage.

**WARNING**

Any safety restraint that is stretched due to everyday use must be replaced. Since damaged or worn safety restraints may not protect the wearer, if the restraint shows any signs of damage or wear it must be replaced. Failure to comply may result in death, personal injury, equipment or property damage.

**WARNING**

A safety restraint that gets caught in any vehicle hardware (such as the door, bunk, or seat) or rubs against a sharp object must be inspected. Since damaged or worn safety restraints may not protect the wearer, if the restraint shows any signs of damage or wear it must be replaced. Failure to comply may result in death, personal injury, equipment or property damage.

**WARNING**

All safety restraints and safety restraint systems on a vehicle that has been in an accident must be replaced, regardless of whether the safety restraint was in use at the time of the accident or the accident's severity. Visible and invisible damage or wear can prevent safety restraints from protecting the wearer. Failure to comply may result in death, personal injury, equipment or property damage.

**NOTE**

If any safety restraint is not working properly, see an Authorized Service Center for repair or replacement.

Damaged safety restraints in the cab must be replaced. Safety restraints that have been stretched, cut, or worn out may not protect you in an accident. For further information on safety restraints and safety restraint maintenance, see [Safety Restraint System - Inspection](#) on page 324.

Sleeper Bunks and Restraints

This vehicle comes equipped with a sleeper bunk restraint for the primary lower bunk and the optional upper bunk. Sleeper bunk restraints must be used whenever the bunks are occupied by a person while the vehicle is in motion. The sleeper bunk restraint protects sleeping passengers and reduces the risk of being thrown from the bunk in a crash. This device is not designed to hold the occupant in a fixed position on the bunk and cannot prevent all injuries in a crash.

**WARNING**

Use the sleeper bunk restraint whenever the sleeper is occupied during vehicle operation. In an accident, an unrestrained person lying in a sleeper bunk could be seriously injured. He or she could be thrown from the bunk. Failure to comply may result in death, personal injury, equipment or property damage.

1

**WARNING**

A safety restraint's metal tongue may become a striking object during sudden stops or crashes. When not in use, make sure each seat belt is fully wound up on its retractor and properly stowed. Failure to comply may result in death, personal injury, equipment or property damage.

**NOTE**

Responsible operators make sure that all vehicle passengers ride safely. The operator is responsible for informing passengers and co-drivers how to properly use all available safety restraints while in the vehicle.

Lower Sleeper Bunk**WARNING**

Make sure the lower bunk is in the horizontal, latched position during vehicle operation. If left open, stored items may become striking objects during

sudden stops or crashes. Failure to comply may result in death, personal injury, equipment or property damage.

**WARNING**

Any loose items on the upper or lower bunk should be moved to a secured place before vehicle operation. Failure to comply may result in death, personal injury, equipment or property damage.

Before you move the vehicle, check to be sure the lower bunk is in the down position.

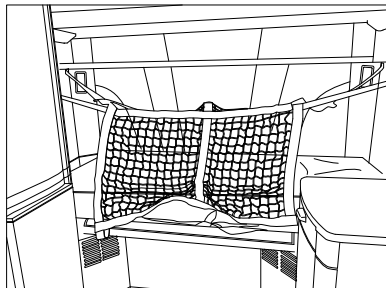
Lower Sleeper Bunk Restraints**Upper Sleeper Bunk****WARNING**

Make sure the latch that holds the upper bunk in the folded position is working properly so the bunk will not fall open during vehicle operation. Pull on the bunk to make sure the bunk is latched securely. Failure to comply may result in death, personal injury, equipment or property damage.

**WARNING**

Any loose items on the upper or lower bunk should be moved to a secured place before vehicle operation. Failure to comply may result in death, personal injury, equipment or property damage.

Federal law prohibits the transportation of persons in commercial vehicles unless they are specifically authorized in writing by the motor carrier. See FMCSR 392.60 - Unauthorized Persons Not to be

Transported for a complete description of the regulation and exemptions.

Upper Sleeper Bunk Restraints

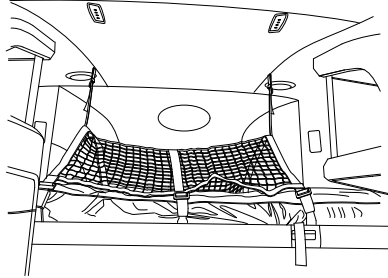

Upper Rear Sleeper Storage

Some vehicles are equipped with an upper storage shelf above the lower bunk.



WARNING

Make sure the lower bunk is in the horizontal, latched position during vehicle operation. If left open, stored items may become striking objects during sudden stops or crashes. Failure to comply may result in death, personal injury, equipment or property damage.

Compartments in the cab and sleeper are provided for storage of necessary items used during operation. The storage areas above the door are designed to hold a combined total not exceeding 14 lbs (6 kg) per compartment. The other overhead compartments (including compartments in the optional sleeper) must hold a combined total not exceeding 5 lbs (2.2 kg) per compartment.

Upper Bunk Ladder

This vehicle can come with an upper bunk ladder. The ladder enables you to climb conveniently into the upper bunk without stepping on the lower bunk. You can unfold the ladder when needed. The ladder folds up below the upper bunk when not in use, while driving, or when accessing the lower bunk.

Observe these rules BEFORE using the bunk ladder:



WARNING

Read the owner's manual before operating the ladder. Failure to comply can result in death, personal injury, proper-

ty damage, or non-warrantable equipment damage.



CAUTION

Surfaces may be slippery.

- Face the ladder when climbing up or down.
- Use both hands when climbing up and down.
- Never climb a damaged, bent, or broken ladder.
- The lower bunk must be in down position before opening and closing the ladder. Never attempt to raise or the lower bunk with the ladder in open position.
- Position both hands a safe distance from the ladder hinges while handling the ladder.
- Make sure that the ladder is fully open before climbing up or down the ladder. The ladder must be the lower bunk profile.
- Do not hang on the ladder while the ladder is in the stowed position.

1

- Close the ladder fully while the vehicle is in motion.
- Do not pull the ladder while it is in the lower position. This act can damage the ladder.
- Lock the ladder when the upper bunk is in stowed position.
- There is low clearance in the bunk ladder area. Make sure not to hit your head.
- Do not exceed the weight limit of the ladder (320 lb).
- Avoid sharp edges.



WARNING

DO NOT attempt to fold or unfold the ladder while an occupant is in the lower bunk. Allow the lower bunk occupant to vacate the bunk before folding or unfolding the ladder. Failure to do so may result in personal injury.



WARNING

DO NOT grip the ladder while folding and unfolding it. Always use an open hand when folding and unfolding the

ladder to prevent injuries and pinching of fingers. Failure to comply may result in personal injury.

To use the upper bunk ladder:

1. Slide the ladder all the way to the right from the stowed position.
2. Release and pull folded ladder down from magnetic rail.
3. Release, pull down and unfold the lower half of the bunk ladder.
4. Place the bottom section of the ladder firmly against the bottom of the bunk.

Ladder Folded and Stowed (viewed from below.)

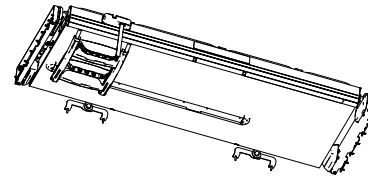

Ladder Partially Unfolded (viewed from above.)

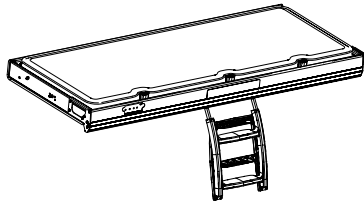

Ladder Unfolded

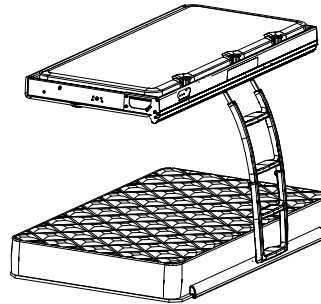

What to Do Before Starting the Vehicle

Safe Vehicle Operation

Make sure to perform pre-trip inspections before starting and operating the vehicle. For your safety, and bystanders, observe the following:

- If you drink alcohol, do not drive.
- Do not drive if you are tired, ill or under emotional stress.

Safe driving is only possible with the proper concentration on the driving task. Keep distractions to a minimum to improve concentration. Examples of distractions include radio controls, GPS navigation controls, cellular telephone calls, cellular text messages, reading or reaching for something on the floor. Minimizing distractions improves safe driving and helps avoid an accident involving death or personal injury.

Be aware of local regulations that surrounding the use of cellular telephones while driving. In addition to being an unsafe practice, some local or federal ordinances

forbid you to use cellular devices while operating the vehicle.

The vehicle was manufactured with advanced engineering techniques, rigid quality control, and demanding inspections. These manufacturing processes benefit from a safe driver, who observes the following and:

- knows and understands how to operate the vehicle and all its controls.
- maintains the vehicle properly.
- applies driving skills wisely.

This manual is not a training manual. It cannot tell you everything you must know about driving a vehicle. For that, you need a proper training program or truck driving school. If you have not been trained, get the proper training before you drive. Only qualified drivers should drive this vehicle. For more information, refer to Department of Transportation Regulation 392.7, which states that interstate commercial motor vehicles are not to be driven unless the driver is sure that certain parts and accessories are in working order.

Do not drive under the influence of alcohol. Your reflexes, perceptions, and judgment can be affected by even a small amount of alcohol. You could have a serious or fatal accident if you drive after drinking. DO

NOT drink and drive or ride with a driver who has been drinking.



WARNING

DO NOT operate the vehicle while impaired. The use of alcohol, drugs, and certain medications can impair perception, reactions, and driving ability. These circumstances can substantially increase the risk of an accident. Failure to comply may result in death, personal injury, equipment damage, or property damage.



WARNING

DO NOT text and drive. Your reaction time, perceptions, and judgment can be affected while texting or using any other form of mobile messaging while driving. Failure to comply may result in death, personal injury, equipment or property damage.

Emergency Equipment

It is good practice to carry an emergency equipment kit in the vehicle. If you have a

roadside emergency, you will be equipped with the following items:

- Window scraper
- Snow brush
- Container or bag of sand or salt
- Emergency light
- Warning triangles
- Small shovel
- First aid kit
- Fire extinguisher
- Vehicle recovery hitches

Drivers Checklist

Make a thorough inspection every day before you drive. Daily inspections keep the vehicle in top shape. It also maintains a high level of safety for you, the passengers, and the load. You save maintenance time later, and the safety checks could help prevent a serious accident. Remember that Federal Motor Carrier Safety Regulation 392.7 requires a pre-trip inspection. So do commercial trucking companies.

The purpose of the inspections is to find anything that could interfere with the safe transportation of yourself, the passengers, and the load. If you find something wrong and cannot fix it yourself, have a qualified technician repair the vehicle.

The following operations must be performed by the driver: Performing these checks and following the maintenance procedures in this manual helps to keep the vehicle running properly.

Vehicle Loading



WARNING

DO NOT exceed the specified load rating. Overloading can result in loss of vehicle control, either by causing component failures or by affecting vehicle handling. Exceeding load ratings can also shorten the service life of the vehicle. Failure to comply may result in

death, personal injury, equipment damage, or property damage.



WARNING

An unevenly distributed load or excessive load over one axle can adversely affect the braking and handling of your vehicle, which could result in an accident. Even if your load is under the legal limits, be sure it is distributed evenly. Failure to comply may result in death, personal injury, equipment or property damage.

The Gross Vehicle Weight Rating (GVWR) or the maximum front and rear Gross Axle Weight Ratings are determined by the components installed from the factory.

(Axle weight ratings are listed on the certification label on the driver's door jamb.)

GVWR

Gross Vehicle Weight Rating. This specification is the MAXIMUM WEIGHT that the vehicle is allowed to carry. This weight includes the weight of the empty vehicle, the loading platform, occupants, fuel, and any load. Never exceed the GVWR of the vehicle.

Gross Combination Weight (GCW)

This weight is the actual combined weight of the vehicle and its load: vehicle, plus trailers, plus cargo.

Gross Axle Weight Rating (GAWR)

This weight is the total weight that one axle is designed to transmit to the ground. This number is listed on the driver's door edge.

Load Distribution

Make sure that any load you carry is distributed so that no axle must support more than its GAWR.

1

Weight Distribution Example

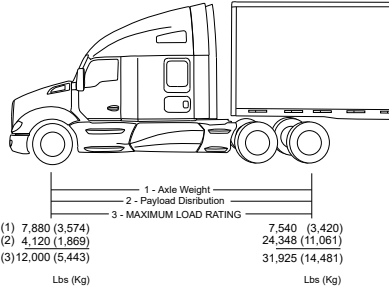

1. Axle Weight
2. Payload Distribution
3. Maximum Load Rating

Front Axle Example

(1)		7,880 lb	(3,574 kg)
(2)	+	4,120 lb	(1,869 kg)
(3)	=	12,000 lb	(5,443 kg)

Rear Axles Example

(1)		7,540 lb	(3,420 kg)
(2)	+	24,348 lb	(11,061 kg)
(3)	=	31,925 lb	(14,481 kg)

Make sure to distribute the load evenly across the axles so that no one axle exceeds its *GAWR*. Also, regardless of a correct *GAWR*, the vehicle and its total load *including trailers* must never exceed the *GCW*.

Visual Inspection While Approaching the Vehicle

While approaching the vehicle, inspect the general appearance of the vehicle and its surroundings for any signs of needed attention.



WARNING

If equipped with a three-piece roof fairing, **DO NOT DRIVE WITH ROOF FAIRING FOLDED DOWN**, since the

marker lamps will not be effective in that position. Failure to comply may result in death, personal injury, equipment damage, or property damage.

Perform these basic inspection steps before operating the vehicle.

1. Check the overall appearance and condition. Are windows, mirrors, and lights clean and unobstructed?
2. Is the air-intake opening clear of obstructions?
3. Check beneath the vehicle. Are there signs of fuel, oil, or water leaks?
4. Check for damaged, loose, or missing parts. Are there parts showing signs of excessive wear or lack of lubrication? Have a qualified technician examine any

questionable items and repair them without delay.

5. Check your load. Is it secured properly?

Daily Checks



NOTE

These checks are in addition to, not in place of, Federal Motor Carrier Safety Regulations. These regulations may be purchased by writing to: Superintendent of Documents U.S. Government Printing Office Bookstore 710 N. Capitol St. N.W. Washington, DC 20402, or ContactCenter@gpo.gov.

Engine

- Engine oil

- Engine coolant
- Power steering fluid
- Engine belt
- Fuel filter (water separator) *Fuel System* on page 312.
- Windshield washer fluid
- Battery cables - check the condition of the battery and alternator cables for signs of chafing or rubbing. Make sure that all clamps (straps) holding the cables are present and in good working order.
- Hood latch
- Brake lines and hoses
- Steering components. Check for loose, broken, or missing parts. Check the pitman arm, drag link, tie rod, steering shaft, and power steering hoses.
- Hydraulic clutch fluid

Chassis and Cab Exterior

- Lamps - are any exterior lamps cracked or damaged? Perform an exterior lamp test. See *Exterior Lighting Self-Test (ELST)* on page 115 for more information.

- Is the air-intake opening clear of obstructions?
- Window and mirrors - clean and adjusted?
- Tires, wheels, and hubs: *Tires* on page 329, *Wheels* on page 332, and *Systems Check* on page 37.
- Suspension components - check for loose or missing fasteners. Check damage to springs or other suspension parts such as cracks, gouges, distortions, bulges, or chafing.
- Brake lines and hoses - check lines, linkages, chambers, parking and service brake operation.
- Air system - *Air System* on page 262.
- Steps and grab handles
- Frame-mounted tanks (fuel, diesel exhaust fluid (DEF), and so on) - check underneath the vehicle for signs of fluid leaks. If any are found, correct before operating the vehicle. Is the tank fill cap secure? Are the tank straps tight? Is the strap webbing in place?
- Trailer connections - are they secure and the lines clear? If they are not being used, are they stored

- properly? Is the trailer spare wheel secure and inflated? Is the landing gear up and the handle secured?
- Fifth wheel - Is the kingpin or the sliding fifth wheel locked?

Cab Interior

- Seat - adjust the seat for easy reach of controls and visibility.
- Safety Restraints - fasten and adjust safety restraints (including sleeper bunk restraints).
- Steering column - adjust for easy reach and visibility.
- Mirrors - check and readjust mirrors if necessary.
- Lamps - Turn the ignition key to the ON position to allow the bulb check and the systems check to test the truck systems. Perform an Exterior Light Self-Test.
- Instruments - Check all instruments (see *Systems Check* on page 37).
- Windshield - Check the operation of windshield wipers and washers.
- Horn - check operation of horn.
- Fuel - Check the vehicle's fuel level. Is there enough fuel?

- Diesel exhaust fluid (DEF) - check level. Is there enough fluid?
- Air conditioning (AC) filters in the cab and/or sleeper - check the condition of the sleeper air conditioning (AC) air filter. Keep the sleeper floor area behind the front passenger seat clear of debris and pet hair. The sleeper air conditioner draws air from this area. Excessive dirt or pet hair shortens the service life of the sleeper air conditioning (AC) air filter.

Weekly Checks



NOTE

These checks are in addition to, not in place of, Federal Motor Carrier Safety Regulations. These regulations may be purchased by writing to: Superintendent of Documents U.S. Government Printing Office Bookstore 710 N. Capitol St. N.W. Washington, DC 20402, or ContactCenter@gpo.gov.

Engine

- Belts

- Hoses
- Clamps
- Radiator
- Air filter and its housing
- Engine Aftertreatment system components
- Exhaust pipes
- Engine air pre-cleaner (option) - For vocational vehicles with optional engine air pre-cleaner, check the purge valve at the bottom of the hood mounted engine air pre-cleaner for any obstructions. Make sure the purge valve will open and close as needed to purge dirt and water from the engine intake air.

Chassis and Cab Exterior

- Battery - check battery and terminals.
- Wheel cap nuts - are they all in place and torqued properly - tighten if necessary. [Wheels](#) on page 332
- Controls and wiring - check for condition and adjustment
- Steering components - check pitman arm, drag link, intermediate shaft U-joint pinch bolt, tie rod,

steering shaft and power steering hoses, etc., for loose, broken, or missing parts.

- Cab air conditioner fresh air filter - check for condition and cleanliness.
- PACCAR FX-20 Front Axle Kingpin Joint Grease/Tie Rod Ends (option) (VOCATIONAL USE) - For vocational vehicles with this axle, grease with Heavy-Duty Multipurpose Lithium Based: #1 or #2 grade, every 50 hours. (Refer to [Front Axle and Suspension](#) on page 269 for maintenance instructions.)

Systems Check

Systems Check evaluates each monitored system and displays its fault status for the operator. The Systems Check can be viewed in the Notifications sub-menu. The Systems Check will also appear when the

Exterior Lighting Self-Test (ELST) is activated.

Systems Check Display

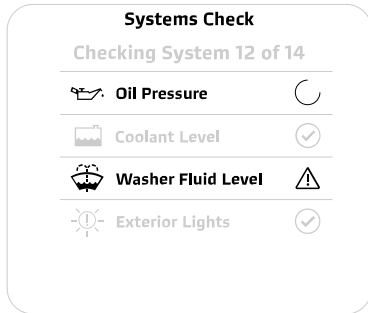

This Systems Check example illustrates the following conditions:

- Engine Oil – Check in progress
- Coolant – OK (no issues)
- Air System – Non-critical issue
- Exterior Lights – OK (no issues)

Other systems may also be checked depending on features installed. Systems Check can be interrupted at any time by:

- Pressing **Select**
- Switching the ELST switch to OFF

- Turning the ignition key to OFF or ACC
- Releasing the Parking Brake

Once the Systems Check has completed, the results will display in a summary. A detailed explanation of this summary can be viewed by accessing the Menu after a Systems Check has completed. The Systems Check can also present the following optional features:

Tire Pressure Monitoring System (TPMS) (option)

One of the systems the vehicle monitors is the Tire Pressure Monitoring System (TPMS).

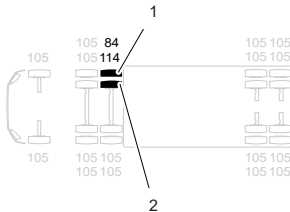

TPMS shows individual tire pressures for each location and will change the color of the tire:

- Outlined – Tire pressure not available

- Gray – Nominal
- Amber – High or low pressure
- Red – Very low or high pressure, or high temperature

To read about tires and recommended maintenance practices, see [Tires](#) on page 329.

System Check Display with TPMS

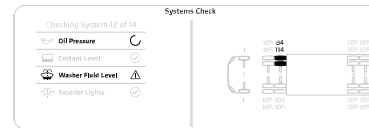

Driver Rewards (option)

If enabled, the Driver Rewards score for Fuel Economy, Engine Idle Time, or both Fuel Economy and Engine Idle Time are shown, as well as general driving tips that can improve brake saving and fuel economy (see [Driver Rewards](#)).

Driver Performance Assistant (DPA) (option)

If enabled, The Driver Performance Assistant score for Braking Habits is shown, as well as general driving tips that

can improve brake saving and fuel economy (see [DPA](#)).

Chapter 2 | EMERGENCY

Roadside Assistance.....	41
Low Air Actions.....	41
Low Oil Pressure.....	41
Stop Engine.....	42
Engine Is Overheating.....	42
How to Inspect and Replace a Fuse.....	44
Where Are the Fuses Located?.....	45
How to Jump Start a Battery.....	45
How to Recover a Vehicle.....	47

Roadside Assistance

Call toll-free to talk to someone at the PACCAR Customer Center.



1-800-KW-Assist (1-800-592-7747)

The Customer Call Center is open 24/7-365 days a year. It is staffed with trained personnel (English and other languages if necessary), free of charge, to provide total roadside assistance. Their custom-mapping system can locate the nearest authorized dealers and Independent Service Providers (ISPs) based on the vehicle's location. In addition, the customer center can dispatch services for jump and pull starts, tires, trailers, fines and permits, chains, towing, hazardous clean-up, out of fuel (roadside), mechanical repairs, and preventive maintenance services. If they cannot answer a specific question, they can direct you to a representative who can.

Low Air Actions



WARNING

If the air pressure falls below 60 psi (414 kPa), the spring brakes may abruptly stop the vehicle. Monitor air-pressure gauges. If the air-pressure alert is activated, **DO NOT DRIVE** the vehicle until it is serviced. Failure to comply may result in death or personal injury.



NOTE

The instrument cluster gauges may appear (if hidden from view), change brightness, and change color to bring attention to a particular system.



These warning lights will illuminate during the start-up self-check. Take no action until you have given them time to extinguish. If either of these warning lights appear *while operating* the vehicle, perform the following actions:

1. Slow down carefully.
2. Move a safe distance off the road and stop.
3. Place the transmission in neutral (park with an automatic transmission, if equipped). Set the parking brake.
4. Turn OFF the engine.
5. Turn ON the emergency flasher. Also use other warning devices to alert other motorists if you have them (reflective triangles, portable lights).

If the warning lights appear, or audible alarm sounds, (while not in start-up self-check) **DO NOT** attempt to drive the vehicle. Contact the nearest authorized dealer to have the problem corrected.

Low Oil Pressure





CAUTION

DO NOT operate your vehicle with insufficient oil pressure as this will cause serious engine damage. Failure to comply may result in equipment or property damage.

It is important to maintain oil pressure within acceptable limits. If oil pressure drops below the minimum psi (kPa) the oil pressure gauge illuminates and changes color. Additionally, the Stop Engine Lamp turns red.

1. Slow down carefully.
2. Move a safe distance off the road and stop.
3. Place the transmission in neutral (park with automatic transmissions, if equipped). Set the parking brake.
4. Turn OFF the engine.
5. Turn ON the emergency flasher. Use other warning devices to alert other motorists.
6. Wait a few minutes to allow the oil to drain into the engine oil pan. Check the oil level.

7. If necessary, add oil. If the problem persists, contact an authorized dealer as soon as possible.

Stop Engine



This warning light appears with an audible alarm tone when a major engine system problem exists.



WARNING

If the stop engine warning light turns on, a serious engine system problem has occurred. Safely stop the vehicle and turn OFF the ignition. Do not drive the vehicle until the vehicle has been serviced. Failure to comply may result in death, personal injury, equipment damage, or property damage.

Engine Is Overheating



CAUTION

Routinely inspect cooling system hoses and clamps for damage. A cracked, split, worn, or loose hose or clamp could result in a leak, leading to a sudden loss of coolant resulting in an overheat condition. Failure to comply may result in equipment damage or property damage.



NOTE

The system may also temporarily overheat during severe operating conditions such as:

- Climbing a hill on a hot day
- Stopping after high-speed/high-load driving
- Debris blocking air flow through the cooling module (radiator)

If the engine overheats, **DO NOT TURN THE ENGINE OFF UNLESS** a low water warning device indicates a loss of coolant. The following applies if the engine coolant temperature rises, or is already above normal: (Also, there cannot be any other warning alarms displayed in the instrument cluster.) If so, complete the following steps:

1. Reduce the engine speed. You can also stop the vehicle. If stopped, place the transmission in neutral (N). Set the parking brake. Keep the engine running.



WARNING

To reduce the chance of personal injury, vehicle damage and/or death from overheated engines, which can result in a fire, never leave the engine idling without an alert driver present. If the engine should overheat, as indicated by the engine coolant temperature light, immediate action is required to correct the condition. Continued unattended operation of the engine, even for a short time, may result in serious engine damage or a fire. Failure to comply may result in death, personal injury, equipment or property damage.



WARNING

Removing the fill cap on a hot engine can cause scalding coolant to spray out and burn you badly. If the engine has been in operation within the previous 30 minutes, be very careful in removing the fill cap. Protect face, hands, and arms against escaping fluid and steam by covering the cap with a large, thick rag. **DO NOT** try to remove it until the surge tank cools down

or if you see any steam or coolant escaping. Always remove the cap very slowly and carefully. Be ready to back off if any steam or coolant begins to escape. Failure to comply may result in death, personal injury, equipment or property damage.



NOTE

Keep the engine running at idle speed. Only shut off the engine if a warning icon indicates to do so.

2. Check to make sure that the oil pressure gauge reads normal.
3. Make sure that the engine fan rotates by switching the **Engine Fan Switch** (if equipped) from AUTO to MAN (Manual).
4. Idle the engine to reduce the coolant temperature. If the temperature does not begin to drop, shut off the engine. Then contact the nearest authorized dealer.
5. If the temperature begins to return to normal, allow the engine to idle for 3 to 5 minutes. Shut it off only after the temperature returns to

normal. Idling the engine allows the engine to cool gradually and uniformly.

6. If overheating came from severe operating conditions, the temperature must drop while parked. If it has not, stop the engine. Let it cool before checking to see if the coolant is low.
7. Park on level ground to receive accurate readings. Check the coolant level at the coolant surge tank.

Check the coolant level after each trip when the engine is cool. The coolant level must be visible within the surge tank. If necessary, add coolant.

How to Inspect and Replace a Fuse

Switch off the ignition. Switch off all lights. Locate the fuses in either the cab, sleeper, or main power fuse box. All the electrical circuits have fuses to protect them from a short circuit or overload. If an electrical component on the chassis stops working, the first thing you must check for is a blown fuse.



WARNING

DO NOT replace a fuse with a fuse of a higher rating. Doing so may damage the electrical system and cause a fire. Failure to comply may result in property damage, personal injury, or death.



WARNING

Never patch fuses with aluminum foil or wire. This may cause serious damage elsewhere in the electrical circuit, and it may cause a fire. Failure to comply may result in death, personal injury, equipment damage, or property damage.



CAUTION

If a circuit keeps blowing fuses, have the electrical system inspected for a short circuit or overload by an authorized dealer as soon as possible. Failure to do so could cause serious dam-

age to the electrical system and/or vehicle.



CAUTION

Before replacing a fuse, turn OFF all lights and accessories and remove the ignition key to avoid damaging the electrical system. Failure to comply may result in equipment or property damage.

1. Switch off all lights and accessories. Remove the ignition key to avoid damaging the electrical system.
2. Determine from the chart on the fuse panel which fuse controls that component.
 - If the circuit has a fuse, remove that fuse. See if it is blown.
 - If the circuit has a poly switch, have the electrical system inspected by an authorized dealer.

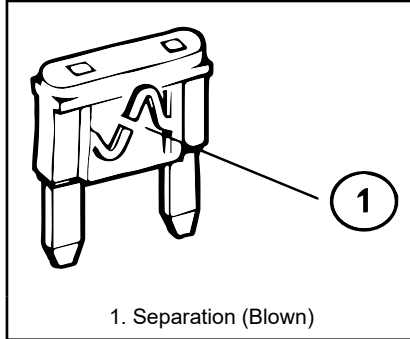
Blown Fuse

3. If it is blown, replace it with a fuse of the same rating. If a fuse of the same rating is not available, a fuse of a lower rating can be temporarily substituted. You can also use a fuse from a circuit you can do temporarily without (for example an accessory circuit or radio).

**CAUTION**

When replacing a failed polyswitch (circuit breaker), always use an ap-

proved polyswitch (circuit breaker) with a current rating equal to or less than the polyswitch (circuit breaker) being replaced. Only use the approved Type II modified reset polyswitch (circuit breaker). NEVER use a Type I (automatic reset) or Type III (manual reset) polyswitch (circuit breaker). A fuse with a current rating equal to or less than the polyswitch (circuit breaker) being replaced can also be used.

**CAUTION**

Always close and latch the engine compartment fuse box cover. A latched cover ensures a watertight seal which will protect electrical components. Failure to comply may result in equipment or property damage.

Where Are the Fuses Located?

Fuses for the cab are located in the fuse panel behind the driver's side kick panel. Main power relays are located in the Power Distribution Center (PDC), in the engine

compartment, mounted to the front wall of the cab.

Fuses for the optional sleeper are located in a separate fuse box accessible through the luggage compartment door.

How to Jump Start a Battery**WARNING**

Batteries contain acid that can burn and gases that can explode. Ignoring safety procedures may result in death, personal injury, equipment or property damage.

**WARNING**

Never jump start a battery near fire, flames, or electrical sparks. Batteries generate explosive gases that could explode. Keep sparks, flames, and lighted cigarettes away from batteries. Failure to comply may result in death, personal injury, equipment damage, and property damage.



WARNING

When jump starting using a battery charger/booster, verify that the battery charger/booster is set to the same jump start voltage and amperage specifications as the vehicle electrical system and batteries (for example, if the vehicle electrical system is a 12 volt system, the jump start voltage on the battery charger/booster shall be set at no higher than a 12 volt setting). Failure to comply may cause an explosion and/or fire resulting in death, personal injury, and/or equipment or property damage.



WARNING

Heed all warnings and instructions of the jumper cable manufacturer. Failure to comply may result in death, personal injury, equipment or property damage.



CAUTION

Applying a higher voltage booster battery will cause expensive damage to electronic components, such as relays and the radio. Failure to comply may result in equipment damage.



CAUTION

Improper hook-up of jumper cables or not following these procedures can damage the alternator or cause serious damage to both vehicles.



CAUTION

Vehicles equipped with an Engine Start Module (ESM) should not be jumped using the ESM Starter terminal (S+). Failure to comply may result in arcing or battery damage.

1. Remove any conductive jewelry. It cannot come in contact with the battery terminals.

2. Select a jumper cable that is long enough to attach to both vehicles. Make sure that neither vehicle touches each other.
3. Position the two vehicles together, but do not allow them to touch.
4. Turn OFF all lights, heater, radio, and any other accessory on both vehicles.
5. Set the parking brake.
6. Shift the transmission into park position or neutral for manual transmissions.
7. If either vehicle is equipped with battery disconnects, make sure that they are in the **OFF** position before connecting the two vehicles.
8. Attach one end of a jumper cable to the **positive (+)** terminal of the discharged (dead) battery. The positive terminal has a large red + or P on the battery case, post, or clamp.

**NOTE**

If your vehicle is equipped with an Engine Start Module (ESM), attach the positive (+) cable to the vehicle battery and not the ESM Starter terminal (S+). See the Maxwell Installation Guide and User Manual for additional information about LED status conditions, maintenance, and troubleshooting.

9. Attach the other end of the same cable to the **positive (+)** terminal of the good (booster) battery.
10. Attach the remaining jumper cable **FIRST** to the negative (-) terminal (black or N) of the charged battery.
11. Attach the other end of the negative cable to the negative (-) terminal of the dead battery.

**NOTE**

Always connect positive (+) to positive (+) and negative (-) to negative (-).

12. If either vehicle is equipped with battery disconnects, make sure that they are in the **ON** position.

13. Start the vehicle that has the good battery first.
 - Let it run for 5 minutes, or
 - If charging a system containing an Engine Start Module (ESM), let it run for 15 minutes. Briefly pressing the Push-to-Test button on the ESM indicates the ESM's charge state. When the status LED presents a solid green light, the ESM is sufficiently charged.
14. Start the vehicle that has the discharged (dead) battery.

The engine must start. If the engine fails to start, do not continue to crank the starter. Instead, contact the nearest authorized dealer.

**WARNING**

When disconnecting jumper cables, make sure they do not get caught in any moving parts in the engine compartment. Failure to comply may result in death, personal injury, equipment or property damage.

Reverse the above procedure exactly when removing the jumper cables. With the

engine running, disconnect the jumper cables from both vehicles in the exact reverse order. Make sure to first remove the negative cable from the vehicle with the discharged battery.

How to Recover a Vehicle**CAUTION**

Remove the drive axle shafts or lift the driving wheels off the ground before towing the vehicle. Towing the vehicle with either the wheels on the ground or the axle shafts in the axles will cause damage to the axle gears.

**CAUTION**

If your vehicle has a Meritor axle with a driver-controlled main differential lock, install the caging bolt before removing the axles for towing. Installing the caging bolt prevents damage by locking internal axle components in position.

**CAUTION**

Connect recovery rigging only to hitch-eyes intended for that purpose. DO NOT attach to bumpers or brackets. Use only equipment designed for this purpose. Failure to comply may result in equipment damage.

**WARNING**

Before towing a vehicle, test your air brakes to ensure that you have properly connected and inspected the recovery vehicle's brake system. Failure to do so could lead to a loss of vehicle control which may result in an accident involving death or personal injury.

All lubricating and clutch application oil pressure is provided by an engine-driven pump, which will not work when the engine is stopped. You could seriously damage your vehicle by towing it with the driveline connected and the drive wheels on the ground. When vehicles are towed, either by wrecker or piggyback, the lubricant in the top front of the drive axle will drain to

the rear and will leave the top components dry. The resulting friction may damage them. Always remove the main drive axle shafts before towing your vehicle.

1. Review and understand all the cautions and warnings of this section.
2. Disconnect the drive axle shafts and cover the open hubs. This is necessary because no lubricant will reach the gears and bearings if the transmission is driven by the driveshaft (rear wheels on the ground), causing damage to the transmission.

See [Preparing the Axles for Towing](#) on page 52.

3. Connect the towing chain or cable using best recovery practices.

See [Best Practices for Recovery Rigging](#) on page 54.

4. Make sure the recovered vehicle's parking brake is released.

See [Parking Brake Manual Release](#) on page 49.

5. If you desire to use the recovered vehicle's brake, ensure that the vehicle's air system is connected to that of the recovery vehicle. Ensure

that any air line that has been removed from a driver-controlled main differential lock is firmly capped to prevent loss of air pressure from the recovery vehicle if it is supplying air pressure. If you do not desire to use the recovered vehicle's brake, ensure that you cage the spring brakes before attempting to move the vehicle.

See [Manually Locking a Differential](#) on page 53.

6. Follow state/provincial and local laws that apply to vehicles in tow.
7. Do not tow vehicles at speeds in excess of 55 mph (90 km/h).

For additional information concerning heavy duty truck recovery, refer to the following Technology & Maintenance Council (TMC) literature.

- Recommended Practice #602-A — "Front Towing Devices For Trucks and Tractors"
- Recommended Practice #602-B — "Recovery Attachment Points For Trucks, Tractors, and Combination Vehicles"
- Recommended Practice #626 — "Heavy Duty Truck Towing Procedures"

Copies of this literature can be obtained from the following address: Technology & Maintenance Council 950 N. Glebe Road Arlington, VA 22203 Phone: (703) 838-1763 Email: tmc@trucking.org Website: <https://tmc.trucking.org/>

Parking Brake Manual Release

When brake air pressure is too low, you cannot release the parking brake from the cab. In such cases, the parking brake (or spring brake) can be manually released.

WARNING

DO NOT drive a vehicle with malfunctioning brakes. If one of the brake circuits becomes inoperative, braking distances will increase substantially and handling characteristics while braking will be affected. You could lose control of your vehicle or cause an accident. Have it towed to the nearest dealer or qualified repair facility for repair. Failure to comply may result in death, personal injury, equipment damage, or property damage.

WARNING

DO NOT operate a vehicle when the spring brakes have been manually released. Driving a vehicle after its spring brakes are manually released is extremely dangerous. The brakes may not function. Failure to comply may result in death, personal injury, equipment or property damage.

WARNING

DO NOT disassemble a spring brake chamber. These chambers contain a powerful spring that is compressed. Sudden release of this spring may result in death or personal injury.

WARNING

Releasing the spring brakes on an unsecured vehicle could lead to an accident. The vehicle could roll, which may result in death, personal injury, equipment or property damage. Always secure the vehicle with wheel chocks,

chains, or other safe means to prevent rolling before manually releasing the spring brakes.

Manually release the spring brake system by performing the following procedure:

1. Remove the cap from the spring chamber.

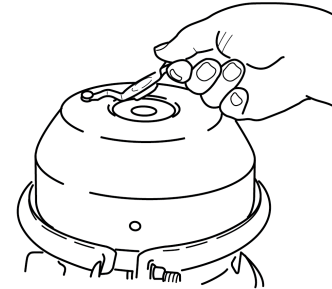

2. Remove the release stud assembly from the side pocket. Then remove the release nut and washer from the release stud.

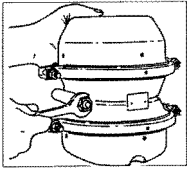

3. Slide out the release stud.

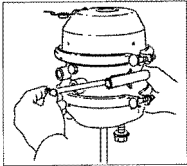

4. Insert the release stud through the opening in the spring chamber where the cap was removed. Insert it into the pressure plate. Turn the release stud 1/4 turn clockwise in the pressure plate. This action secures the cross pin into the cross pin area of the pressure plate. It also locks it into the manual release position.

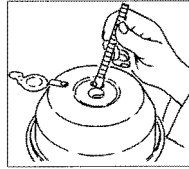

5. Assemble the release stud washer and nut on the release stud.

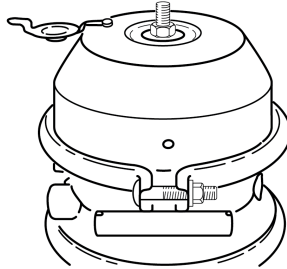

6. With a wrench, turn the release stud assembly nut until the compression spring is 90-95 percent caged. While turning, make sure that the pushrod (adapter pushrod, or service pushrod) retracts. DO NOT over-torque the

release stud assembly. (S-cam-type maximum: 50 lb-ft (68 N·m), Wedge-type maximum: 30 lb-ft (41 N·m)). The spring brake is now mechanically released.

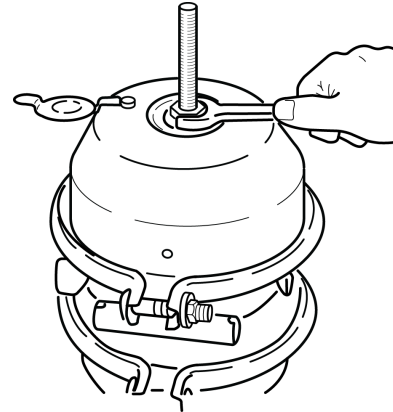

Recovery Hitch

The vehicle is equipped with a removable recovery hitch. This hitch is a device that attaches to the sockets in the front bumper used when the vehicle requires recovery. These hitches are designed for short distance and intermittent duty to help pull a vehicle. These hitches are not designed to

be used as towing devices for a long distance.

Specially designed hitches are required to recover the vehicle. The recovery hitches attach to the frame. Two hitch assemblies, made up of the following parts, are recommended for the proper recovery of the vehicle:

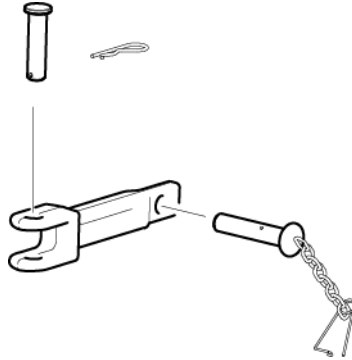

If the vehicle is not equipped with the proper recovery hitch assembly, contact an authorized dealer to obtain the proper equipment.

WARNING

DO NOT use parts from other vehicles or materials from other sources to repair a hitch or to replace a missing hitch. The parts provided for recovery are made of high strength materials and are specifically designed for vehicle recovery. Failure to use the correct factory equipment may result in an accident involving death or personal injury.

CAUTION

Connect recovery rigging only to hitches intended for that purpose. DO NOT attach to bumpers or brackets. Use only equipment designed for this purpose. Failure to comply may result in equipment damage.

How To Use a Recovery Hitch

CAUTION

Recovery pull maximums assume that the tow rigging evenly distributes the load between both recovery hitches. Connect the rigging according to recovery rigging instructions to avoid serious vehicle damage. Failure to comply may result in equipment or property damage.

CAUTION

When recovering ditched or bogged vehicles, stay well below maximum capacities. Even at loads below maximum, the stresses of extraction can damage various parts of the vehicle.

Use the following procedure to install the Vehicle Recovery Hitches. See the Recovery Hitch Assembly illustration for part identification.

1. Check the square sockets behind the lower front bumper for obstructions. If necessary, clear them.

2. With lock pins removed, insert the hitches through the bumper and into the square hitch socket.
3. Align the hole in the tow hitch with the square hitch socket hole.
4. Insert the lock pin into the square hitch socket hole. Make sure that the lock pin lock tab is within the socket.
5. Rotate the lock pin 90 degrees to secure the pin in place.
6. Make sure to install the tow pin and lock clip before using the hitch.
7. Remove the hitches after recovering the vehicle. Store all parts for future use.

Preparing the Axles for Towing

Towing the vehicle with the front end raised can damage the differentials. To avoid this damage, prepare the axles before towing. It is possible to connect the air lines of both vehicles during towing. If so, make sure that the recovered vehicle does not have an open air line. An open air line on the recovered vehicle causes a leak in the air system of the recovery vehicle. This leak could cause a loss of system air, which can cause the service brakes not to function. This failure results in the sudden

application of the spring brakes causing wheel lock-up and loss of control. This condition can lead to a rear-end collision with a following vehicle.



WARNING

An open air line on the recovered vehicle will cause a leak in the air system of the recovery vehicle if both vehicles' brake systems are connected. This could cause a loss of system air, which can cause the service brakes not to function, resulting in the sudden application of the spring brakes causing wheel lock-up, loss of control, or overtake by following vehicles. You could be in an accident involving personal injury or death. Ensure that any air line that has been removed from a driver-controlled main differential lock is firmly capped to prevent loss of air pressure from the recovery vehicle if it is supplying air pressure.

1. Lift the driving wheels off the ground. Alternatively, you can remove the driveline and axle shafts before towing the vehicle.



CAUTION

Failure to lift the driving wheels off the ground or remove the driveline and axle shafts before towing the vehicle could seriously damage your vehicle. All lubricating and clutch application oil pressure is provided by an engine-driven pump, which does not work when the engine is stopped. When vehicles are towed either by wrecker or piggyback, lubricant in the top front of the drive axle will drain to the rear. This will leave the top components dry, resulting in friction that will seriously damage these components.

2. If the vehicle has a driver-controlled differential lock, then manually lock the differential.
3. Remove drive axle shafts.
4. Cover the open ends of the hubs to prevent dirt and debris from entering the axle.

**CAUTION**

Water, dirt, and other material can enter an open hub or axle. This can contaminate the axle fluid and cause possible damage to components. Ensure that the hubs are covered with plastic whenever a drive axle shaft is removed.

Manually Locking a Differential

Follow these procedures if the vehicle has a driver controlled differential lock. Always lock the differential when the axles are being removed to aid in re-installation. This procedure should be done before the axle shafts are removed.

**CAUTION**

Failure to install the caging bolt when towing vehicles with driver-control main differential lock can result in damage by failing to lock internal components in position.

**WARNING**

An open air line on the recovered vehicle will cause a leak in the air system of the recovery vehicle if both vehicles' brake systems are connected. This could cause a loss of system air, which can cause the service brakes not to function, resulting in the sudden application of the spring brakes causing wheel lock-up, loss of control, or overtake by following vehicles. You could be in an accident involving personal injury or death. Ensure that any air line that has been removed from a driver-controlled main differential lock is firmly capped to prevent loss of air pressure from the recovery vehicle if it is supplying air pressure.

**NOTE**

A recovered vehicle will have no operational brake system. Additionally, the rear axle spring brakes will probably be applied.

- To use the recovered vehicle's brakes, connect the vehicle's air system to that of the recovery vehicle. Firmly cap any air line that has been removed from a driver-controlled main differential lock. The cap prevents loss of air pressure from the recovery vehicle.
- If you are not using the recovered vehicle's brakes, cage the spring brakes before attempting to move the vehicle.

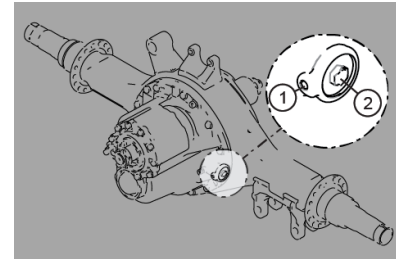

1. Remove the air line and firmly cap the air line from the vehicle. (2)
2. Remove the caging bolt from its storage hole. (1)
3. Screw the caging bolt into the air line hole. (2)
4. When fully engaged, a 0.25-0.5 in. (6.35-12.7 mm) space will remain

between the air cylinder and the bolt head. This action will lock the differential by pushing a piston into a "lock" position.

2

Recovery Hitch Capacities

The maximum rated loads for vehicle recovery varies depending on the direction or angle of pull. These capacities are listed in the table below and are for the two hitches working together, simultaneously.

Direction of Pull	Maximum Capacity lbs. (kg)
Directly forward	80,000 (36,000)
Directly vertical or horizontally to the side	14,600 (6,600)
45 degrees in any direction	20,000 (9,000)

Best Practices for Recovery Rigging

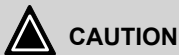

Recovery pull maximums assume that the tow rigging evenly distributes the load between both recovery hitches. Connect the rigging according to recovery rigging instructions to avoid serious vehicle damage. Failure to comply may result in equipment or property damage.

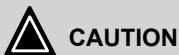

When recovering ditched or bogged vehicles, stay well below maximum capacities. Even at loads below maximum, the stresses of extraction can damage various parts of the vehicle.

Recovery Rigging Options

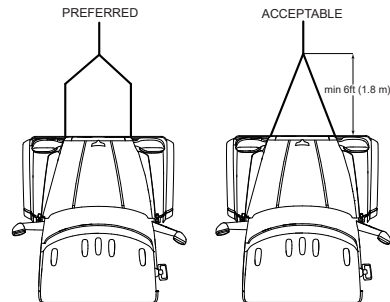

Use a double chain or cable setup that distributes the load equally to both hitches (see either example in the Recovery Rigging Options illustration):

- Never loop a single chain or cable through both hitches, also known as reeving (not shown).
- Use a spreader or equalizer bar to distribute the load on both hitches (preferred), or
- If a spreader bar is unavailable: connect the main tow chain or

- cable no closer than 6 ft. (1.8 m) from the vehicle (acceptable).
- Secure the towed vehicle using two additional chains or cables.

Returning to Service After Recovering

Once the vehicle is recovered, the axles must have oil added to prevent gear damage during operation.

1. Into the pinion cage, add 1 pt (.47 L) of lubricant or into the interaxle differential, add 2 pt (.94 L) of approved lubricant.
2. After adding the specified type and amount of lubricant, drive the vehicle. It must be unloaded. Drive 1 mi to 2 mi (1.5 km to 3 km) at a speed lower than 25 mph (40 km/h). This action circulates the lubricant through the assembly.
3. If the parking brake is manually released, they must be modified back to their normal operating condition.
4. If the differential lock was manually locked, it must be re-locked. The caging bolt must be put back in its storage location. The differential

lock air line must also be re-installed in its normal position.

Add the correct lubricant back to the axles after recovering the vehicle and before putting it back into service.

What to do if the Vehicle is Stuck in Sand, Mud, Snow, or Ice



WARNING

DO NOT spin the wheels faster than 35 mph (55 km/h). Spinning a tire at speedometer readings faster than 35 mph (55 km/h) can be dangerous. Tires can explode from spinning too fast. Under some conditions, a tire may be spinning at a speed twice that shown on the speedometer. Any resulting tire explosion could cause injury or death to a bystander or passenger, as well as extensive vehicle damage: including tire, transmission, and/or rear axle malfunction.

These suggestions are provided to improve the ability to free a vehicle if the vehicle gets stuck in sand, mud, snow, or ice:

- Move the gearshift lever or selector from first gear to reverse.

- Apply light pressure on the accelerator pedal while the transmission is in gear.
- Remove the foot from the accelerator while shifting.
- Do not race the engine.
- For the best traction and safety, avoid spinning the wheels.

Follow these practices to avoid transmission damage:

- Always start the vehicle in motion with the shift lever in first gear.
- Make sure that the transmission is fully engaged in gear before releasing the clutch pedal (manual only).
- Do not shift into reverse while the vehicle moves forward.
- Another vehicle can be used to pull the vehicle free. If so, do not permit the vehicle to be towed for long distances before removing the driveshaft.

If tire chains are needed, make sure that they are installed on both sides of the driving axle. Installing chains on only one side of the axle can cause equipment damage.



CAUTION

Chains on the tires of only one tandem axle can damage the driveline U-joints and the inter-axle differential. Repairs could be costly and time-consuming. Failure to comply may result in equipment damage.



WARNING

Secure the roof, side, and chassis fairings while towing from the rear. An unsecured fairing may come off of the vehicle during transit while towing from the rear. Failure to comply may result in death, personal injury, property or equipment damage.

roof, side, and chassis fairings. Damage occurs if you do not secure these items.

Towing the Vehicle

Dealer or commercial towing services have the necessary equipment to tow the vehicle safely. The towing service is aware of towing regulations and safety precautions. Using a towing service makes sure that the following precautions are taken:

- Use of a safety chain system
- Follow all local towing regulations
- Make sure that the towing device does not contact any surfaces that could be damaged while in transit
- If towing from the front, make sure that the rear axles are prepared for towing
- If towing from the rear, make sure that all body components are secured. These items can include

Chapter 3 | CONTROLS

3

Instrument Cluster.....	60
Digital Display Controls.....	61
Digital Display.....	62
Selecting a View.....	65
Menu Configurations.....	70
Truck Information.....	75
Drive Summary.....	75
Driver Rewards (option).....	76
Driver Performance Assistant (Option).....	77
Bulb Check.....	77
Notifications.....	77
Warning Lights and Indicators.....	78
Optional Gauges.....	93
Steering Wheel Controls.....	94
Steering Column Controls.....	95
Dash Switches.....	100

Door-Mounted Mirror Controls.....	121
Digital Mirror System.....	122
Heating and Air Conditioning (AC).....	139
Sleeper Alarm Clock.....	147
Cab Accessories.....	148

Instrument Cluster

For information on using the dash and instrument cluster options while driving,

see the paragraphs that follow. Please remember that each vehicle is custom-made. Your instrument panel may not look exactly like the one in the pictures that follow. We have tried to describe the most

common features and controls available. You can pick out the parts that apply to you and read them to be fully informed on how your particular vehicle operates.

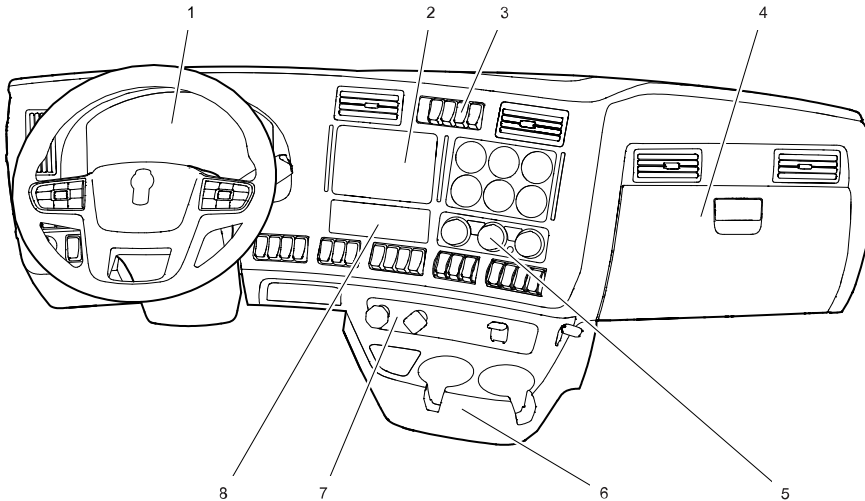

1. *Digital Display*
2. *Navigation/ Infotainment (or Optional Gauges)*
3. *Light Switches*
4. *Glove Box*
5. *Air Conditioning*
6. *Cupholders*
7. *Parking Brake*
8. *Radio*

Left-Side Dash

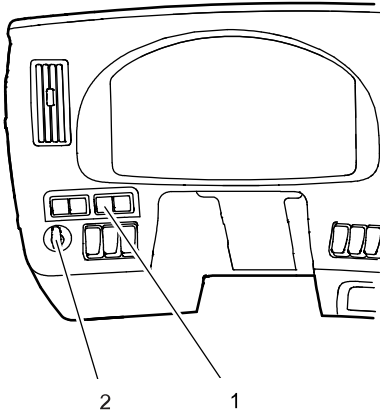

1. Additional Switches
2. Ignition Switch

Digital Display Controls

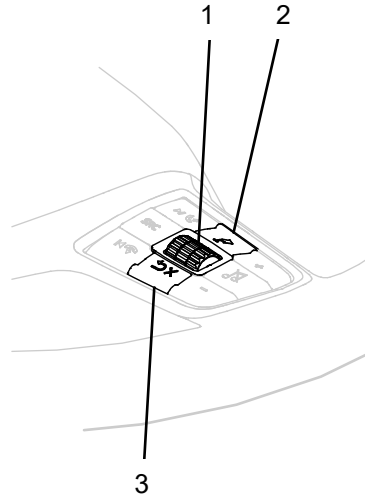

1. Scroll Wheel
2. Shortcut
3. Back/Cancel

The controls located on the right pod of the steering wheel are used to manipulate content within the display. The shortcut

button will access items that are configured in the settings, see [Shortcuts](#) on page 74.

Scroll Wheel

Use the scroll wheel to adjust the level of gauge view detail within the display or navigate through menus and make selections. The scroll wheel is bi-directional and is also a button. Press down on the scroll wheel to open and select menu options, to change settings when in the menu, and suppress notification messages when allowed.

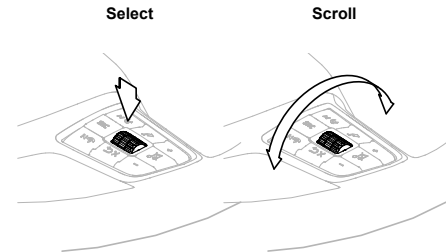

For example, vehicle time can be set using the Scroll Wheel.

Press down (**Select**) to open the menu:

Menu Example: Main

Scroll to Settings and then (**Select**) again to choose the Settings sub-menu: Then **Scroll** to Set Time and press **Select**.

Menu Example: Time



Finally, **Scroll** through the values and press **Select** to set the time.

Menu Example Set Function

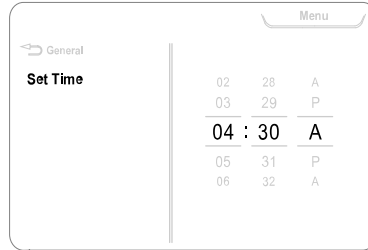

In the context of viewing notification messages in the display, the icon will show an arrow when the **Select** function is available:

Select



Back/Cancel

Use the **Back/Cancel** button to return to the previous menu, suppress a notification,

or cancel a selection. See [Notifications](#) on page 77.

Digital Display

The digital display is visible during all driving situations and in some parked situations. When the parking brake is set, the following actions will wake the display, making it visible:

- Opening (or keeping open) the cab doors
- Using steering wheel switches
- Tapping the brake
- Turning the ignition switch to **ON**, **ACC**, or **START**
- Starting the engine

If after 20 seconds, none of these actions are taken, the display will darken to conserve power, but will awaken when any wake action is performed. If the Anti-Theft option is active and you attempt to start the engine, a passcode prompt will appear. The engine cannot be started until the correct passcode is entered (see [Anti-Theft](#) on page 74).

Display Indications

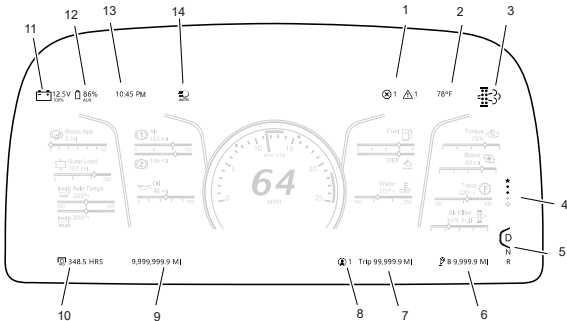

1. Active Warnings
2. Outside Air Temperature
3. Diesel Particulate Filter Status
4. View Indicator
5. Gear Shift Indicator
6. Trip Segment
7. Trip Odometer
8. Odometer
9. Engine Hours
10. Battery
11. Aux Battery Indicator
12. Clock
13. High Beam Assist (HBA)²

Active Warnings

Red or amber in-dash notifications are counted, and the total is displayed by the active warning indicator. In addition, these counts are also presented in:

- Systems Check
- The Notifications Sub-menu

- A Drive Summary
The total count may change without user interaction if individual warnings are intermittent, time based, self-correcting, or are otherwise rectified.

Outside Air Temperature

Outside Air Temperature monitors the ambient air temperature outside the truck. The display alerts the driver to high and low temperature conditions. When the outside temperature approaches freezing (36°F or 2°C) an icon appears next to the temperature (snowflake for freezing and thermometer for high) and a chime will

² Not on all models.

sound. The system's unit of measure (Fahrenheit or Celsius) can be changed by navigating to the settings menu. The outside air temperature display uses a sensor (located at the bottom of the driver's side mirror assembly) to measure outside air temperature only. It is not capable of displaying the temperature of the road surface on either the temperature display or the snowflake icon. Additionally, the outside air temperature reading may be affected by exposure to direct sunlight.

View Indicator

The View Indicator identifies which view is currently selected:

- Minimized
- Minimized with Advance Driving Assistance (Optional)
- Basic
- Enhanced
- Favorites (if enabled)

Drive, Neutral, and Reverse Indicator



The Drive, Neutral, and Reverse Indicator reflects the shifter position for automatic and automated transmissions. Manual transmissions and certain automatic transmissions do not provide feedback to the display. Instead, the transmission shifter indicates the gear condition.

Trip Segment Odometer

The Trip Odometer can be split into smaller segments denoted with letters from A to Z. Pressing the way-point marker button on the steering wheel causes the segments to increment. Segment B is the first indicated because Segment A is the total trip until the way-point marking is used. The maximum distance of segments is 9,999.9, after which the system automatically increments to the next letter. If the total trip or segments exceed the systems capacity, there is a notification on the screen or the data collection will stop until the total trip is reset. Trip data and the segmentation

information can be found in the menu under [Trip Summary](#) on page 70.

Trip Odometer

The Trip Odometer shows how far the vehicle has traveled during the current trip (since it was last reset). The current trip can be segmented with way-point markers. The maximum distance that can be shown on the Trip Odometer is 99,999.9 at which point the operator must reset the trip. Press and quickly release the **Way-point marker** to set segments. Press and hold the **Way-point marker** to reset the total trip and reset the segment back to A. (Item 1 in the following image):

Left Switch Pod

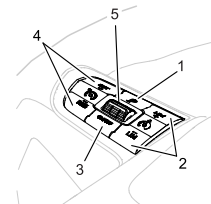

1. Trip way-point marker
2. Limiter control
3. Cruise control ON/OFF

4. Cruise control set-resume
5. Toggle switch

The operator can then view the marked segments and total trip data captured in the [Trip Summary](#) on page 70.

Odometer

The Odometer displays the total elapsed mileage of the truck. The maximum mileage the Odometer is able to display is 9,999,999.9. The Odometer rolls over to zero if the maximum mileage is achieved.

Engine Hours

Engine hours display the total number of hours operated by the engine. The maximum hours displayable by the counter are 99,999.9 before the counter rolls over to zero.

Battery Voltage

The Battery Voltage indicator shows the battery icon, voltage, and the state of charge. The battery icon will be replaced with the Low Voltage Disconnect (LVD) icon when Low Voltage Disconnect is active. The battery icon is gray when

operating normally, but changes to amber to indicate a low voltage condition and red to indicate a high or very low voltage condition.

Clock

The clock displays either a 12-hour or 24-hour format. Change clock settings in the Settings Sub-menu.

Transmission Gear Display

Vehicles with PACCAR TX-12/TX-18 or Eaton Endurant automated transmissions will show the transmission mode, current gear, and diagnostic information associated with the transmission. Vehicles with manual transmissions will show the current gear. This display does not apply for vehicles with Allison transmissions.

Selecting a View

The instrument cluster has 5 views for the operator to use.

- Minimized

- (Optional) Minimized with Advanced Driver Assistant
- Basic View
- Enhanced View
- Favorites

Each view is identified by a specific view indicator on the right side of the display area.

Minimized View

A combination speedometer and tachometer will show in the center of the Minimized View.

Speedometer and Tachometer

Vehicle and engine speed are presented at the center of the display. The vehicle speed units default to the requirements where the vehicle was originally purchased. The operator may select the Dual View that shows both Standard and Metric units from the Digital Display menu (see [Units and Language](#) on page 70) or by using the steering wheel **Shortcut** button (see [Digital Display](#) on page 62).

Minimized View with Driver Assistance (Option)

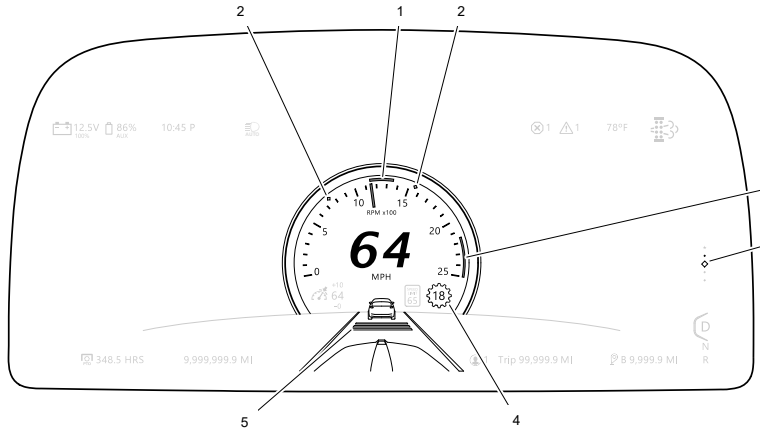

- 1. Optimal RPM Indicator
- 2. Smart Tach®
- 3. Engine Speed
- 4. Transmission Gear
- 5. Driver Assistance Area
- 6. View Indicator

Adaptive Cruise Control Notification (option)



This indication at vehicle start means it is equipped with Adaptive Cruise Control (ACC) and Collision Mitigation. These features work together to improve driver safety and enhance the driving experience. When Cruise Control is active, ACC accelerates and slows the vehicle to maintain a chosen distance from a detected forward vehicle. Collision Mitigation attempts to prevent a forward collision when the vehicle is advancing at

speeds greater than 15 mph (24 kph). Please review the ACC section of this manual, and the manufacturer's manual, prior to driving this vehicle.

Basic View and Enhanced View

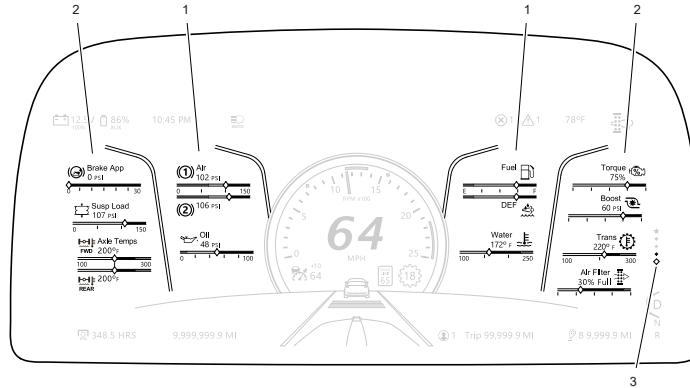
Enhanced View

1. Gauges for Basic View
2. Gauges for Enhanced View Only

3

Basic View

This view combines the instrumentation presented in Minimized View with gauges such as Air Pressure, Oil Pressure, and Coolant Temp.

Enhanced View

This view includes all the gauges present in the Basic View, adding gauges on the left and right in the display. The gauges in

this view are determined by the way the truck was configured at the factory and their layout is based upon priority. Additional gauges might show on the screen if they go into a warning state and will appear below these enhanced gauges, which will shrink to make room.

Gauges

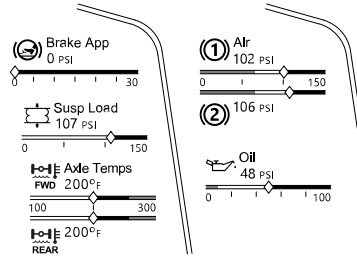

Gauge Locations are determined by a prioritized layout at the factory. A customizable layout is available in a feature called 'Favorites' located at the bottom of the View Indicator. (See [Favorites](#) on page 72.)

i NOTE
The instrument cluster gauges may appear (if hidden from view), change brightness, and change color to bring attention to a particular system.

Diesel Exhaust Fluid (DEF) Diesel Engines Only

The diesel exhaust fluid gauge shows the approximate amount of DEF fluid in the DEF tank.

DEF Level Gauge (dual tank version)

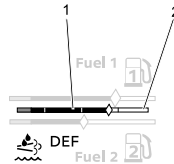

1. Level indicator
2. Low warning threshold

⚠ CAUTION
Only use Diesel Exhaust Fluid (DEF). Failure to do so may damage components of the diesel particulate filter (DPF).

Besides empty and full, the gauge also indicates 1/4, 1/2, and 3/4 of total capacity. DEF fluid is required to meet certain emission requirements. A warning icon and notification message will appear when the

DEF level is low. Warnings can also occur if something other than DEF is put in the tank or if the system is tampered with. In this case the needle will still read high in the scale, but the gauge will show red warning colors and icons. Ignoring these warnings can result in an engine de-rate that progresses until the warnings are corrected. Do not allow your DEF tank to remain empty. Please refer to your emission supplemental manual for more details about DEF fluid.

i NOTE
The instrument cluster gauges may appear (if hidden from view), change brightness, and change color to bring attention to a particular system.

Fuel Level

Fuel Level Gauge (Dual Tank Version)

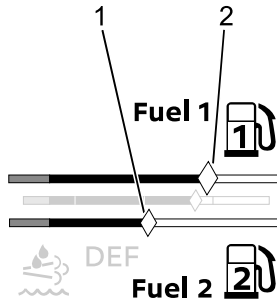

1. Tank 1 Level Indicator
2. Tank 2 Level Indicator

The fuel gauge indicates the fuel level. When the fuel level gets low, gauges will highlight with colors to highlight the warning. The MPG gauge will change to the usage rate of fuel when idling.



WARNING

DO NOT carry additional fuel containers in your vehicle. Fuel containers, either full or empty, may leak, explode,

and cause or feed a fire. Failure to comply may result in death or personal injury.



WARNING

Diesel fuel in the presence of an ignition source could cause an explosion. A mixture of gasoline or alcohol with diesel fuel increases this risk of explosion. DO NOT remove a fuel tank cap near an open flame. Use only the fuel and/or additives recommended for your engine. Failure to comply may result in death, personal injury, equipment or property damage.



CAUTION

Use only Ultra Low Sulfur Diesel (ULSD) Fuel, as recommended by engine manufacturers. High-sulfur diesel fuel will damage the aftertreatment system and impact the engine emissions which will result in the engine not meeting emission regulations. Failure

to comply may result in equipment or property damage.



NOTE

For more information on fuel specifications, consult the engine operator's manual.



NOTE

This vehicle may be manufactured with different fuel systems and different draw tube locations. Because of this and the amount of road crown, it is recommended that you do not operate your vehicle with less than one-quarter of your truck's fuel capacity. Allowing the fuel level to go below one-quarter of capacity could result in the lack of fuel to keep the engine running. Keep the fuel tanks at least half-full to reduce condensation of moisture in the tanks. This moisture can damage the engine.



NOTE

The instrument cluster gauges may appear (if hidden from view), change brightness, and change color to bring attention to a particular system.

3

Favorites View (optional)

Vehicles with Favorites View will allow the operator to customize the arrangement of many of the gauges. Using the Favorites View requires the operator to **Scroll** to select the View. The Favorites view (if available) is located below Enhanced View. See [Favorites](#) on page 72 to customize the Favorites view.

Menu Configurations

The following menus

- Notifications
- Trip Summary
- Settings
- Truck Information

are accessible when

1. The parking brake is set
2. All active popup messages are viewed and suppressed
3. The **Select** button is pressed

These menus allow the operator to configure settings on the vehicle.

Notifications

Notifications display system messages related to the condition of your vehicle. It displays:

- Tire Pressure Monitoring System (TPMS) (optional)
- Active messages
- Systems Check Summary

Trip Summary

Trip Summary presents a summary of details such as fuel economy and distance of the trip, collected during the main trip and/or trip segments. These details will be collected until the Trip is reset, or the max trip distance (99,999.9 miles for main trips, 9,999.9 for trip segments) is reached.

Settings

Settings allows the operator to customize the Display. Settings in this area of the menu include general aspects, favorites configuration, and assigning a shortcut.³

General

Time

This menu allows the operator to customize the clock.

24-Hour Time Choose between a 12- or 24-hour format. AM or PM (A or P) displays only in the 12-hour time format.

Automatic Time (optional) When enabled, trucks with Automatic Time receive time zone appropriate data.

Set Time Using Automatic Time disables Set Time. Set the clock to indicate the local time.

Units and Language

Units

Use this setting to change the units of measurement between Standard, Metric (Bar), and Metric (psi).

³ If Anti-Theft is enabled, Settings will not be accessible until the correct passcode is entered.

**NOTE**

This feature may be disabled on some trucks.

Language

Use this setting to change the language.

Features

Features allows the operator to enable optional features on the vehicle to customize their experience.

Predictive Cruise Control Overshoot

Configure the Predictive Cruise Control Overshoot through this menu item. See [Predictive Cruise Control \(Option\)](#) on page 173 for more details about Overshoot and Predictive Cruise Control.

Low Voltage Disconnect (LVD) Setup

Change the LVD battery voltage set point for the LVD to switch on [Low Voltage Disconnect \(LVD\) \(option\)](#) on page 294.

Trailer Detection (Option)

When enabled, the Trailer Detection feature detects a connected trailer. The system also notifies the operator when a trailer connection is absent.

Digital RPM

Digital RPM provides a digital numeric readout of the engine speed in the speedometer. Digital RPM is automatically shown when using PTO and may also be shown when not using PTO if selected in settings.

**NOTE**

If dual speedometer is selected, Digital RPM may not be shown.

Windshield Wiper Interlock

Windshield Wiper Interlock activates the headlights when the windshield wipers switch on.

**NOTE**

Some fleets may configure trucks to default to this behavior and remove the option to set this from the menu.

Dark Cabin

A dark cabin prevents cab interior lights from switching on when a cab door opens.

Shutdown Timer**WARNING**

Never idle your vehicle for prolonged periods of time if you sense that exhaust fumes are entering the cab. Investigate the cause of the fumes and correct it as soon as possible. If the vehicle must be driven under these conditions, drive only with the windows open. Failure to repair the source of the exhaust fumes may result in death, personal injury, equipment or property damage.



CAUTION

DO NOT allow your engine to idle, at low rpm (400-600 rpm), longer than five minutes. Long periods of idling after the engine has reached operating temperatures can decrease engine temperature and cause gummed piston rings, clogged injectors, and possible engine damage from lack of lubrication. The normal torsional vibrations generated can also cause transmission wear.



NOTE

DO NOT stay in the vehicle with the engine running or idling for more than 10 minutes with the vehicle's Heater and A/C ventilation system in RECIRC or at LOW FAN SPEED. Even with the ventilation system on, running the engine while parked or stopped for prolonged periods of time is not recommended.



CAUTION

Prolonged periods of idling can result in lower than optimal engine/transmission operating temperatures, which can cause increased rates of wear. **Do not allow the engine to operate at idle for extended periods at temperatures at or below 160°F (71°C).** To help prevent this from occurring on PACCAR engines, an idle shutdown feature can be programmed to shut the engine down after a period of low idle operation with no driver activity. A flashing warning light will inform the driver of an impending shutdown. Failure to comply may result in equipment or property damage.



NOTE

If you are required to idle your vehicle for long periods of time, install an auxiliary heater or automatic idle control. These auxiliary devices can reduce fuel consumption and save you money.

When active, the Shutdown Timer will keep the engine running briefly after the ignition is switched OFF and the key can be removed. This feature allows the driver to exit the cab, lock the doors, and walk away. Normally, keeping the engine running requires the key to remain in the ignition, potentially leaving the cab unlocked and accessible. When the timer reaches zero, the engine stops, and the electrical system shuts down just as if the key were moved to the OFF position. When activated, the Shutdown Timer duration remaining shows below the Drive Summary. This duration can be altered by using the scroll wheel on the steering wheel. (See [How to Set the Shutdown Timer](#) on page 183). The timer is limited to a maximum of 30 minutes.

The truck can have the Engine Idle Shutdown Timer (EIST) option. If so, and if it is set for a shorter shutdown time, the engine shuts down at the shorter timer setting.

Favorites

To disable Favorites, contact an authorized dealer. When Favorites View is active, the operator can create a customized arrangement of all but centrally located gauges. To change the Favorites

configuration, stop the truck, set the parking brake and:

- Access Favorites via the Settings Sub-menu. OR
- **Scroll** to Favorites (represented by a star in the View Indicator) and press **Select**.

Adding a Gauge to Favorites

The truck must have the parking brake set to add a gauge. Navigate to the "Edit Your Favorites" menu to perform this procedure. It is not possible to assign an already assigned gauge. Remove the gauge first. See [Removing a Gauge From Favorites](#) on page 74.

1. **Scroll** the list until you locate the desired gauge or compound gauge.

Edit Your Favorites

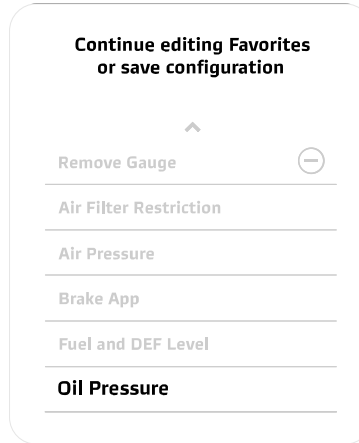

If the gauge is already present in the Favorites view, it is not present as a menu option.

2. **Select** to choose the gauge you want to position.
3. **Scroll** through the valid locations. (These positions can include

positions currently holding a gauge). Highlight that position.⁴

Edit Your Favorites (Left-Side of Image)

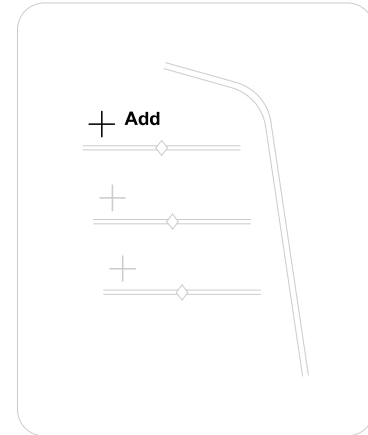

4. **Select** to add or replace the gauge. Navigate and **Select** "Save Configuration" when you are happy with the arrangement. The display reads "Your favorite configuration has been saved." Press **Back** to exit Editing Favorites.

⁴ An invalid position reads "Not Available."

Removing a Gauge From Favorites

Set the parking brake. At least one gauge must be in the Favorites view. You cannot remove the speedometer, tachometer, fuel, or air pressure gauges. If the gauge you want to remove is part of a multiple gauge group, you must remove the whole group.

1. **Select** "Remove Gauge."
2. **Scroll** to highlight the gauge and **Select**.

Navigate and **Select** "Save Configuration" if this is the last change you want to make to Favorites view. The display reads "Your favorites configuration has been saved." Press **Back** to exit Editing Favorites.

Shortcuts

Use the Shortcuts option to assign one of the following features to the **Shortcut** button:

- Dark Cabin – Toggles Dark Cabin On/Off.
- Digital rpm – Provides a numeric readout of rpm within the speedometer.

- Dual Speedometer – Shows a compound Speedometer with both Standard and Metric values.
- Favorites – Selects the Favorites View on the Display.
- Metric Units – Switches all measured units used on the display between Standard and Metric.

Anti-Theft

Anti-Theft prevents a driver from starting the engine unless the Anti-Theft passcode is entered.⁵

If Anti-Theft is enabled, turning the ignition switch to **START** prompts the operator to enter the passcode. Once the correct passcode is entered, the driver will have five minutes to start the engine. If the engine is not started within that time, the passcode must be entered again.⁶

To enable or disable Anti-Theft, toggle the Anti-Theft (ON/OFF) state in the settings sub-menu, and then enter the current passcode.

How To Enter the Passcode

You must have the ignition key and the current passcode.

The default passcode is 0000 at the factory. See an authorized dealer if you need a custom passcode. With the anti-theft feature switched off, the operator does not need a passcode to start the engine.

⁵ Anti-Theft also prevents accessing the settings sub-menu.

⁶ Timer can be postponed in one-minute intervals using any steering wheel switch.

- Using the **Scroll**, scroll to the first number in the code. Then press **Select**.

Anti-theft First Digit

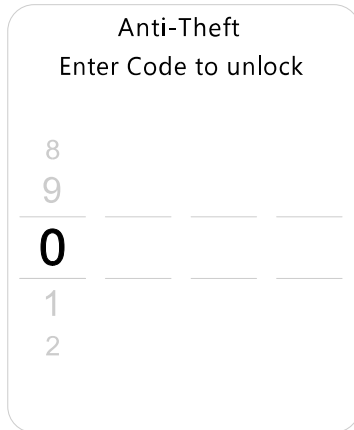

The next digit is selected.

- Scroll** to the number that you want for this digit and press **Select**. The next digit is selected.
- Use this process to select all four digits.

Anti-theft Last Digit

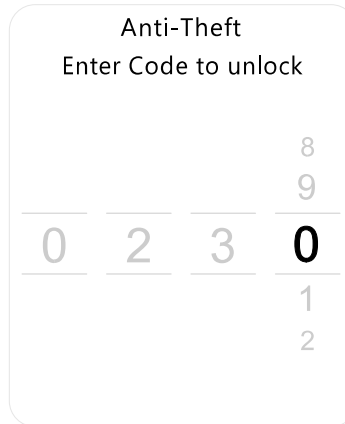

The display reads "turnkey to Start Engine."

Truck Information

Truck Information stores specifications and data about the vehicle:

- Chassis
- Engine

- ABS
- Transmission (option)
- Adaptive Cruise (option)
- Predictive Cruise (PACCAR Engines Only)
- GHG Speed Limiter (option)
- Tire Pressure Monitor (option)
- Digital Vision System (option)
- Lane Departure Warning (option)
- Lane Change Assist (option)
- Lane Keeping Assist (option)
- Other Software
- PTO (option)

Detailed information for listed components or features can be shown by scrolling (using the **Scroll**) to the item and then pressing **Select**.

Drive Summary

The Drive Summary presents information about the most recent leg of travel and is shown when the ignition key is turned to "off." The Drive Summary consists of

- Critical and Non-critical Issues (see [Systems Check](#) on page 37)
- Shut Down Timer (if active) (see [Shut Down Timer](#) on page 71)

- TPMS (option) (see [Systems Check](#) on page 37)
- Driver Rewards (option) (see [Systems Check](#) on page 37)
- Driver Performance Assistant (option) (see [Systems Check](#) on page 37)
- Three customer-selected reports (i.e. Idle Time, Fuel Economy)

The Drive Summary collects information since the last time the engine was off for at least two hours. When insufficient information has been collected, Drive Summary will show dashes for the monitored component or report. Customer-selected reports can be changed at your local dealership.

Driver Rewards (option)

If enabled, Driver Rewards raises or lowers the vehicle's max-allowable speed based on whether a programmed, fuel economy goal is met. This goal is defined by the customer and can be based on fuel consumption, engine idle time, or both fuel consumption and idle time. The driver is assigned a score based on how successfully they meet or exceed this goal. Driver Rewards is only available for

vehicles equipped with a PACCAR MX engine.

The fuel consumption goal is met by reducing the amount of fuel used over a given distance. This is achieved by

- Driving slower
- Minimize Speed Changes
- Accelerating gently
- Coasting in gear
- Using the Cruise Control
- Maintaining optimal tire pressure
- Reducing the trailer gap
- Running a Warmer Cab
- Turning off extra electrical loads

The engine idle time goal is met by reducing the time the engine idles (running the engine when the vehicle is not in motion).

The Driver Rewards score is based on driving habits. This score is compared to the goal and a max-speed bonus or penalty is determined. The Driver Rewards score is shown during a Systems Check and in the Driver Summary. When there is a bonus or penalty, it appears below the Cruise Control (CC) indicator on the dash, and the max-allowed speed shows to the right of the CC indicator. Driving habits that reduce fuel use will earn the operator a higher max speed; habits that consume

more fuel will lower the max speed. Driver Rewards will never grant a bonus that exceeds programmed federal emission regulated or customer defined speed limits. During the Systems Check, the Driver Rewards and DPA features offer general driving tips that can increase fuel economy and brake savings. These features also provide feedback in the Driver Summary based on a driver's specific driving habits. This advice if followed can improve future Driver Rewards and DPA scores. Driver Rewards has three customer-determined modes of activation: only when CC is in use, when CC is not being used, or at all times. The Driver Rewards goal and the amount of penalty or bonus is also customer-determined and should be based on reasonable expectations for a known route of travel. The Driver Rewards goal should be reconsidered if the manner of vehicle use or the vehicle route changes significantly.

To enable or disable Driver Rewards, or change the mode of activation, reward amounts, or set a new Driver Rewards goal, contact your dealership.

Driver Performance Assistant (Option)

If enabled, the Driver Performance Assistant (DPA) determines how skillfully the operator uses coasting and the engine brake when reducing vehicle speed. Coasting and engine brake use, instead of frequent, aggressive use of the service brakes, can extend brake life and increase fuel economy. The DPA assigns the driver a score based on their braking habits and provides suggestions on how to improve these habits. The DPA feature is only available for vehicles equipped with a PACCAR MX engine.

The driver's DPA score is determined by comparing their braking and coasting habits against a customer-defined goal for braking use and coasting. A score that meets or exceeds this goal will award positive feedback in the Driver Summary. During the Systems Check, the DPA and Driver Rewards features offer general driving tips that can increase fuel economy and brake savings. These features also provide feedback in the Driver Summary based on a driver's specific driving habits. This advice, if followed, can improve future

DPA and Driver Rewards scores (see Driver Rewards). To enable or disable the DPA or set a new DPA goal, contact your dealership.

Bulb Check

When the ignition switch is turned ON multiple warning icons will be displayed in a sequence to test each warning light indicator. The total sequence should take no more than 10 seconds to complete. Have your instrumentation system checked by a qualified service technician if it does not successfully complete.

Audible Alarm

The audible alarm will sound in conjunction with most warning lights. These events include but are not limited to headlight on, fifth wheel, stop engine, primary/secondary air, and driver door open warnings.

Optional Icons

Additional icons may be operational depending on individual vehicle specifications.



Some optional lights may illuminate even though your vehicle is not equipped with that particular feature.

Notifications

A notification communicates vehicle information. Notifications can be red, amber or white. Red and amber notifications are totaled in the Active Warnings Indicator at the top of the display. Notifications' characteristics (color, brilliance, and whether it flashes or has an audible alarm) depend on the condition that generated the notification.



1. Stack Size – The lower number indicates how many notifications are in the stack (suppressible and

non-suppressible), and the upper, which notification is being viewed.

2. Title – Notification.
3. Suppressibility – Indicates if the current notification is suppressible.⁷
4. Instructions – Contains instructions or elaborating information.

When multiple notifications are present, each is assigned a priority and placed in a stack. Higher priority notifications are placed towards the front of the stack. The **Select** button cycles through the active notifications, allowing each notification in the stack to be viewed.

Some notifications, once viewed, are removed from the stack; these notifications are called suppressible. Suppressible notifications show an “X” below the **Select** icon and typically don't require an immediate response. Suppress these notifications using the **Back/Cancel** button (or the **Select** button when the parking brake is set). Non-suppressible notifications cannot be removed from the stack until the parking brake is set.

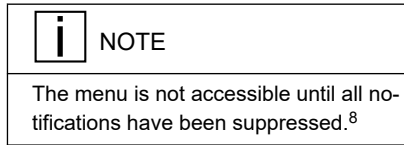

Viewing and Suppressing Popups

A Popup can be read and suppressed by pressing the Scroll Wheel. Some situations may require pressing **Back/Cancel** instead. For example, the popup in the following image is suppressed by pressing the Scroll Wheel (indicated with a down arrow) OR by pressing the **Back/Cancel** (indicated with an X below the roller).

Suppressable Popup Message

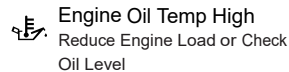

1/2

Warning Lights and Indicators

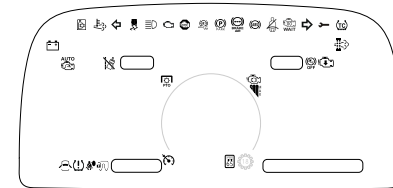

The instrument panel communicates many vehicle conditions using warning lights (also called telltales), indicators, and audible alarms and tones. Alarms and tones are sometimes accompanied by an indicator or warning light. Some indications are communicated for informational purposes only – indicators – while warning lights often require an operator response and are frequently accompanied with a notification (see [Notifications](#) on page 77). Warning lights, indicators, and audible alarms and tones may indicate a system malfunction or attempt to draw attention to the component it monitors, so they should

⁷ The **Select** icon shown is for vehicles equipped with a Menu Control Switch (MCS); steering wheel switches indicate differently.

⁸ All notifications become suppressible when the parking brake is set.

be checked frequently and responded to promptly. These indications could save you from a serious accident. Some of these indications also present an associated notification, providing additional information (see [Notifications](#) on page 77). Red and amber notifications are tallied at the top of the display and can be viewed in the notifications sub-menu when the parking brake is set. Additionally, gauges may become visible on the Digital Display and may change color or brightness to bring the gauge to the operator's attention.

a failure of an important system, such as the brakes, which could lead to an accident. Failure to comply may result in death, personal injury, equipment damage, or property damage.

Physical Telltales

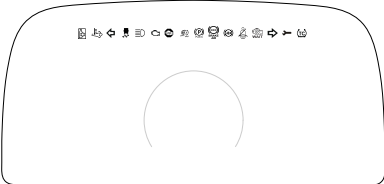

Physical telltales will always appear across the top of the display.

Dedicated Telltales

Dedicated Telltales always appear in the same location on the display. Some are

visible only when active but most signify that the monitored component requires operator attention.

Dynamic Telltales

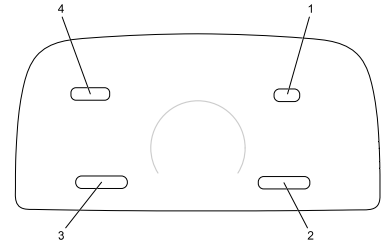







Dynamic telltales appear on the display in the rows indicated. A dynamic telltale communicates the status of a monitored component, which may require the operator to respond or take action.









WARNING







Do not ignore any type of tone or lights. These signals tell you that something is malfunctioning on your vehicle and provide you an indication of what system is affected. It could be







Indications

Title	Symbol	Color	Std	Opt
ADAS Camera Fault on page 84		Amber		•

Title	Symbol	Color	Std	Opt
<i>Antilock Brake System (ABS)</i> on page 84		Amber	•	
<i>Anti-lock Brake System (ABS), Trailer</i> on page 84		Amber	•	
<i>Stability Control (Option)</i> on page 85		Amber	•	
<i>Traction Control</i> on page 85		Amber	•	
<i>Transmission, Failure</i> on page 93		Red		•
<i>Diesel Particulate Filter (DPF)</i> on page 87		Amber	•	
<i>Differential, Inter-Axle Lock</i> on page 86		Green		•

Title	Symbol	Color	Std	Opt
<i>Dump Truck, Body Up</i> on page 87		Red		•
<i>Dump Truck, Gate</i> on page 87		Amber		•
<i>Engine, Check Engine</i> on page 89		Amber	•	
<i>Engine Brake Indicator</i> on page 88		Green		•
<i>Engine, Low Coolant Level</i> on page 89		Amber	•	
<i>Engine, Overspeed</i> on page 89		Red		•
<i>Stop Engine</i> on page 42		Red	•	
<i>Engine Wait-to-Start Light</i> on page 90		Amber		•

Title	Symbol	Color	Std	Opt
<i>Emissions, High Exhaust System Temperature</i> on page 88		Amber	•	
<i>Emissions, Engine Derate</i> on page 90		Amber	•	
<i>High Beam Assist (HBA)</i> on page 90		Green		•
<i>Hill Hold</i> on page 91		Amber		•
<i>Lane Departure Warning (LDW)</i> on page 91		Amber		•
<i>Lane Departure Warning (LDW) Fault</i> on page 91		Amber		•
<i>Lights, High Beam</i> on page 91		Blue		•

Title	Symbol	Color	Std	Opt
<i>Malfunction Indicator Light (MIL)</i> on page 92		Amber		•
<i>Park Brake</i> on page 86		Red	•	
<i>Seat Belt, Fasten</i> on page 92		Red	•	
<i>Transmission, Oil Temperature High</i> on page 93		Amber		•
<i>Turn Signal, Left</i> on page 93		Green	•	
<i>Turn Signal, Right</i> on page 93		Green	•	

ADAS Camera Fault



This amber warning light appears when a fault occurs with the camera used by the various Advanced Driver Assist Systems (ADAS) features: Lane Departure Warning (LDW), Lane Keeping Assist (LKA), and Adaptive Cruise Control (ACC). The LDW and optional LKA features are both dependent on the ADAS camera, and both will be disabled when this warning occurs. In addition to issues internal to the camera, please read the topic Lane Departure Warning (LDW) for conditions which may limit camera performance, resulting in an ADAS Camera Fault.

Antilock Brake System (ABS)



Illuminates during the Bulb Check (see [Bulb Check](#) on page 77). Have the ABS checked by an authorized dealer if the ABS warning lamp stays on for more than 3 s.

- Illuminates during normal operating conditions to indicate a problem with the ABS.

- Illuminates when a problem exists with Automatic Traction Control (ATC).

See also Automatic Traction Control on page 4-33.

NOTE

After servicing the ABS, the lamp stays on after the power-on self-test. This indicates that the ABS wheel sensors have not been checked by the ABS. As soon as the vehicle is driven at speeds above 4 mph (6 km/h) the lamp turns off, indicating that the wheel sensors have been checked by the ABS.

Anti-lock Brake System (ABS), Trailer



Illuminates during bulb check. Have the ABS system checked by an authorized dealer if the ABS Warning Lamp stays on for more than 3 seconds.

- Illuminates during normal operating conditions to indicate a problem with the ABS system.
- Illuminates when a problem exists with Automatic Traction Control (ATC).

This should be checked by an authorized dealer as soon as possible.

NOTE

Tractors/trucks and trailers built after 03/01/2001 must be able to turn on an In-Cab Trailer ABS Warning Light (per U.S. FMVSS121). The industry chose Power Line Communication (PLC) as the standard method to turn it on. On trailers built prior to 03/01/2001, verify trailer ABS system status via the required external warning light mounted on the trailer. The indicator light on the trailer should be amber and identified with the letters ABS.

Stability Control (Option)



Calculates the driver's intended path of travel from wheel speed and steering angle sensors, then compares calculations to the actual direction of travel. The system uses individual wheel brakes to re-adjust the path of the vehicle.

- The Stability Control Icon (ESC or Electronic Stability Control) illuminates during the Bulb Check when the ignition is switched ON. The lamp switches off after a few seconds if no system problems are detected. If a problem is detected, the ESC Warning Lamp will switch on and stay on.
- Illuminates when the ESC system is regulating individual wheel brakes to correct the vehicle's direction of travel. (Refer to Advanced ABS with Stability Control for more information.)

 **WARNING**

If this chassis is equipped with an Electronic Stability Control (ESC) and is modified (for example, adding or removing an axle, converting from a truck to a tractor, converting from a tractor to a truck, changing the body, lengthening of the wheelbase and/or frame, relocating frame components, or modifying pneumatic or electrical ABS/ESC harnesses) the ESC must be evaluated by a qualified technician. If you have any questions, contact your authorized dealer. Failure to comply may result in death, personal injury, equipment damage, or property damage.

 **NOTE**

For more information about the stability control system installed on your vehicle, please refer to additional material supplied with this operator manual, included in your glove box informational packet.

Traction Control



Monitors wheel speed for poor traction. If a wheel begins to slip due to poor traction, Traction Control will reduce engine power, and or apply brakes in an effort to regain traction.

- Illuminates during the Bulb Check when the ignition is switched ON. The lamp switches off after a few seconds if no system problems are detected. If an ATC problem continues, the ATC warning light will switch on, and stay on.
- Illuminates when the ATC is regulating wheel spin and switches off after the traction control event has ended.
- Flashes continuously when the ATC/Deep Snow & Mud switch is placed in the on position, indicating that this feature is active.



WARNING

If this chassis is equipped with an Electronic Stability Control (ESC) and is modified (for example, adding or removing an axle, converting from a truck to a tractor, converting from a tractor to a truck, changing the body, lengthening of the wheelbase and/or frame, relocating frame components, or modifying pneumatic or electrical ABS/ESC harnesses) the ESC must be evaluated by a qualified technician. If you have any questions, contact your authorized dealer. Failure to comply may result in death, personal injury, equipment damage, or property damage.



NOTE

For more information about the stability control system installed on your vehicle, please refer to additional material supplied with this operator manual, included in your glove box informational packet.

3

Park Brake



Illuminates when the parking brake is applied.
The Park Brake lamp flashes and warning tone sounds anytime the parking brake is not set and driver's door is open.
Audible alarm sounds if the parking brake is set and speed is greater than 5 miles per hour.

Brakes, Low Air



Illuminates when system air pressure falls below 60 psi.

Cruise Control



This indicator shows the operator which Cruise Control function is currently enabled or active. This includes

- Cruise Control
- Adaptive Cruise Control (optional)
- Predictive Cruise Control (optional)
- Variable Road Speed Limiter (optional)

When a Cruise Control function is enabled, a white indicator will appear. When a Cruise Control function has been activated, the indicator will change from white to green. For more information on use of the various Cruise Control functions, see Cruise Control, Adaptive Cruise Control, Predictive Cruise Control, and Variable Road Speed Limiter.

Differential, Inter-Axle Lock



Illuminates when the inter-axle differential switch is ON thus locking the inter-axle differential. This powers the forward rear and the rear rear differentials equally. When the switch is turned off (inter-axle differential unlocked) the engine power is allowed to flow to any of the four drive tires based on the differential effect (mostly to the forward rear differential). This feature is standard on all tandem axles.

i NOTE

Tractors/trucks and trailers built after 03/01/2001 must be able to turn on an In-Cab Trailer ABS Warning Light (per U.S. FMVSS121). The industry chose Power Line Communication (PLC) as the standard method to turn it on. On trailers built prior to 03/01/2001, verify trailer ABS system status via the required external warning light mounted on the trailer. The indicator light on the trailer should be amber and identified with the letters ABS.

Dump Truck, Body Up



Illuminates when Truck Dump Body is up.

Dump Truck, Gate



Illuminates when Truck Dump gate is open.

Diesel Particulate Filter (DPF)



This warning means that the DPF needs to be regenerated and appears when soot in the DPF exceeds an acceptable amount or a significant amount of hydrocarbons (HC) are detected.

This warning may also appear if the system is attempting to regenerate automatically while the vehicle is in Power Take-off (PTO) mode.

For more information about this warning, consult the Engine Aftertreatment System operator's manual.

i NOTE

This manual describes only the most basic aftertreatment information essential for a driver to operate the vehicle safely. For a more thorough explanation of the emissions system is available in the video linked to the QR code below or in the Engine Aftertreatment Systems Operator's Manual.



Emissions, High Exhaust System Temperature



Illuminates when the exhaust gas temperature and exhaust components become extremely hot.



WARNING

If the High Exhaust System Temperature (HEST) warning light is on, do not park near combustible vapors or materials. Combustibles at least 5 ft. (1.5 m) away from the exhaust (outlet) stream as it exits the tail pipe while the HEST light is illuminated. Failure to do so could ignite an explosion and cause death or serious injury to bystanders and may result in property or equipment damage.



WARNING

If the High Exhaust System Temperature (HEST) warning light is on, do not

park near people. The heat generated by the engine aftertreatment system (EAS) may cause serious burns if EAS components are contacted. Failure to comply may result in death, personal injury, equipment damage, or property damage.



WARNING

When the High Exhaust System Temperature (HEST) warning light is on, the temperature of the tailpipe, exhaust pipes, diesel particulate filter (DPF)/selective catalytic reduction (SCR) device, and surrounding components (including enclosures and steps) becomes elevated and can cause serious burns to the skin. Allow adequate cooling time before approaching, or working on or near, any part of the exhaust system or surrounding components. Failure to comply may result in death, personal injury, equipment damage or property damage.

Malfunction Indicator Lamp (MIL)



Illuminates when an engine emissions failure has occurred. The vehicle can be safely driven but should be serviced to correct the problem. The situation should not be considered an emergency. In some cases, the Malfunction Indicator Lamp activates in conjunction with the High Exhaust Temperature, Diesel Particulate Filter (DPF) and Diesel Exhaust Fluid (DEF) Warning Lights.



NOTE

Only for engines equipped with emissions aftertreatment.

Engine Brake Indicator



This indicator appears when the engine braking (compression brake or exhaust brake) is active. It shows available engine

braking levels near the indicator, with the selected braking level highlighted:



When using engine braking, the engine brake indicator turns green. An override of active engine braking can occur when the operator (or a vehicle feature, such as Adaptive Cruise Control (ACC)) provides acceleration. In these cases, the engine brake indicator turns white (enabled but not active) while the vehicle accelerates.

Engine, Check Engine



Illuminates when a problem exists, but the vehicle can still be safely driven. Vehicle should be serviced to correct the problem, but the situation should not be considered an emergency.

The Check Engine Lamp activates for several reasons including, but not limited to, Water in Fuel, No-Idle Shutdown alert screens, High Exhaust Temperature, Diesel Particulate Filter (DPF), and Diesel Exhaust Fluid (DEF) warning lights. Refer

to your Engine Operator's Manual for additional information.

	NOTE
Only for engines equipped with emissions aftertreatment.	

Engine, Low Coolant Level



Illuminates with an audible alarm indicating critically low coolant level. The vehicle must be serviced to correct the problem but the situation should not be considered an emergency.

Engine, Overspeed



Illuminates when engine RPM is exceeded (Allison Transmissions).

Engine, Overspeed Air Shutdown



Illuminates when the Engine overspeed air shutdown system is activated.

Stop Engine



This warning light appears with an audible alarm tone when the 48 V generator (MX-13 CARB engines only) has failed or when a major engine system problem exists.



WARNING

If the stop engine warning light turns on, a serious engine system problem has occurred. Safely stop the vehicle and turn OFF the ignition. Do not drive the vehicle until the vehicle has been serviced. Failure to comply may result in death, personal injury, equipment damage, or property damage.

Engine Wait-to-Start Light

This warning icon appears when the system needs some time before attempting to start the engine. The light illuminates at key ON, and stays on for as long as 30 seconds.



NOTE

The length of time the 'Wait-To-Start' lamp remains illuminated depends on

the ambient temperature. The lower the ambient temperature, the longer the lamp will be illuminated.

Once the Wait-to-Start light switches off, turn the key to the starting position to start the engine.

You see this light appear when the starter overheats. Alternatively, you can see it when the engine grid heater needs time to warm up.



NOTE

Some engines are equipped with an engine starting motor protection feature. If the starting motor is engaged for 30 or more seconds without the engine starting, the starter is locked out from operating, allowing for proper cooling of the starting motor. During this time, the 'Wait-To-Start' lamp flashes for 2 minutes. Once the lamp stops flashing, the starting motor is allowed to function.

Emissions, Engine Derate

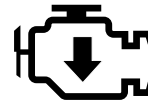

Illuminates when a derate is active.

Fast Idle Control

The display will show the Fast Idle Control (FIC) indicator when enabled or activated. The indicator shows the set RPM value. See [Indicators Around the Speedometer](#) on page 161.

High Beam Assist (HBA)



If your vehicle is equipped with High Beam Assist (HBA), and it is turned ON in the menu, the HBA indicator will illuminate green when enabled, the indicator will illuminate gray when overridden, and the indicator will disappear when disabled. There are two driver override states, see [High Beam Assist \(HBA\)](#) on page 180.

Hill Hold



If equipped with a PACCAR TX-12/TX-18 or Eaton Endurant automated transmission, indicator blinks when disabled by switch (once per second), or continuous with fault.
The hill stop aid prevents unwanted vehicle movement on steep grades when transitioning from the brake to throttle pedal.

Lights, High Beam



Illuminates when the high beams are on. This icon flashes with an audible alarm if the headlights are left ON when the door is opened and the key switch is OFF. In addition, this icon flashes, but without an audible alarm, if there is a problem with the low beam headlights or the low beam headlight wiring. In such event, the high beam headlights turn on at 50% normal brightness.

Lane Departure Warning (LDW)



Illuminates when LDW system is not able to track the vehicle's position within the lane.

	NOTE
For vehicles equipped with Lane Departure Warning, please refer to Lane Departure Warning Driver's Guide for additional information.	

Lane Departure Warning (LDW) Fault



This amber warning light will appear when a fault occurs in the Lane Departure Warning (LDW) system. If this occurs, the LDW feature will be disabled.

Lane Keeping Assist (LKA) Disable (option)



This optional switch will disable the Lane Keeping Assist (LKA) feature. LKA will remain disabled until the next key cycle unless re-enabled by toggling this switch again. This switch lights up green when active.

Lane Keeping Assist (LKA) Fault



This white warning light will appear when there is a fault in the Lane Keeping Assist (LKA) system. When this occurs, the LKA feature will be disabled.

Lane Keeping Assist (LKA) Enabled/ Engaged



Indicates, when white, that the Lane Keeping Assist (LKA) feature is enabled. When green, this indicator signifies that the conditions for LKA have been met and that the vehicle is actively engaged in lane keeping (see [Lane Keeping Assist \(LKA\)](#) on page 178).

Malfunction Indicator Light (MIL)

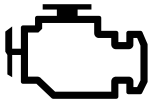

This warning light turns on when an engine emissions failure occurs. An emissions failure is not an emergency, and the vehicle can be safely driven, but should be serviced to correct the problem. In some cases, the MIL will activate in conjunction with the High Exhaust System Temperature

(HEST), diesel particulate filter (DPF), and Diesel Exhaust Fluid (DEF) warning lights.



NOTE

The Malfunction Indicator Light (MIL) turns on if the on-board diagnostics (OBD) system detects a possible emissions system failure. To ensure the condition is corrected, the vehicle should be brought in for service at the earliest opportunity.

Refrigerator



Illuminates to indicate that the refrigerator is on and ignition is off.

Seat Belt, Fasten



Illuminates for 5 seconds whenever the ignition key is turned on, then it turns off. The warning lamp may also come on if the driver's seat belt is not fastened (if the vehicle was ordered with a seat belt warning light option).

Tire Inflation (TPMS)



Illuminates when tire pressures need to be checked.

Torque Assisted Steering Fault



This amber warning light appears inside a Popup when there is a fault in the Torque Assisted Steering system. When the Popup with this symbol occurs, Torque Assisted Steering is not available.



NOTE

Because the optional Lane Keeping Assist (LKA) feature uses the Torque Assisted Steering system, a fault in the Torque Assisted Steering system will also deactivate LKA, if equipped.

Transmission, Auxiliary



Illuminates to indicate auxiliary transmission is in neutral.

Transmission, Failure



Indicates a fault with the transmission. Refer to transmission manual.

Transmission, Oil Temperature High



Illuminates when transmission lubricant temperature is too high.



CAUTION

DO NOT continue to operate an engine when the temperature gauge indicates that the engine is in an overheated state. Continuing to operate an overheating engine can severely damage the engine and other vehicle components (the transmission, for example). The vehicle must be serviced and the problem corrected. Failure to do so may cause severe, non-warrantable equipment damage.

Turn Signal, Left



Blinks when the left turn signal or the hazard light function is operating.

Turn Signal, Right



Blinks when the right turn signal or the hazard light function is operating.

Optional Gauges

For vehicles with a telematic navigation screen, optional gauges will be part of the screen functions. Please refer to the navigation system supplement for further details about its functions and how it works. Some vehicles may have optional analog gauges installed at the factory in place of the navigation screen.

Drive Axle Temperature Gauge (Forward and Rear)



These gauges indicate the temperature of the lubricant in your vehicle's axle(s). These temperatures will vary with the kind of load you are carrying and the driving conditions you encounter. Maximum axle temperature may vary, depending upon the axle and type of lubricant. Very high temperatures signal a need to have your axle lubrication checked.

CAUTION

Driving with very hot temperatures in the rear axles can cause serious damage to the axle bearings and seals. If you notice a sign of overheating, please have your axle lubrication checked.

Depending on the vehicle configuration, there may be a single gauge for more than just the forward and rear driver. The icon will have an "X" over the representative axle to indicate which axle's temperature is being displayed in the gauge.

Manifold Pressure Gauge

This gauge indicates the pressure in the intake manifold. The pressure in the manifold is directly related to the turbo

output and is related to the engine power output.



If the pressure indicated by your manifold pressure gauge goes down, there may be something wrong with your engine. Have it checked by a qualified service technician.

Steering Wheel Controls

CAUTION

DO NOT attempt to service the steering wheel, clockspring, or any of the electrical wiring in the multiplex system, or any steering components (steering column, steering driveline or steering gear). Tampering with these components may result in an inoperable multiplex system. Failure to comply may result in equipment or property damage.

The steering wheel contains controls for commonly used functions so that the operator does not have to take their hands

off of the steering wheel to operate. These controls are also used to interface with the display.

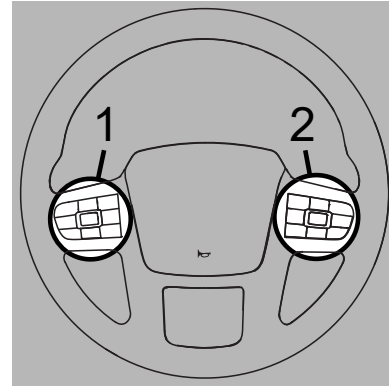

1. Left switch pod
2. Right switch pod

Switches on the left side of the horn pad may include: cruise control functions, way-point marking, an optional road speed limiter, and an optional toggle to set functions such as variable road speed limiter (VRSL), adjustment of adaptive cruise control (ACC), and predictive cruise control (PCC). See [Cruise Control](#) on page 167.

Switches on the right side control infotainment (see [Cab Accessories](#) on page 148) and navigate and configure the instrument cluster (see [Digital Display](#) on page 62).

City Horn

Depressing the horn pad in the center of the steering wheel activates the city horn.

Steering Column Controls

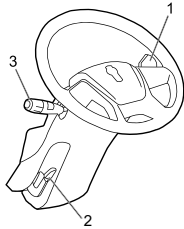

1. Engine brake and/or shifter lever
2. Tilt/telescope lever
3. Turn signal lever

Turn Signal Lever

This lever controls several functions: turn signal, high beam, and windshield wiper control. The turn signal lever will only operate when the key is in the ignition in the ACC or ON position.

Tilt/Telescope Lever

The steering column both tilts and telescopes to allow optimal comfort, visibility to the instrument panel, and reach to the pedals or steering wheel.

- The tilt feature allows the wheel to be moved up and down.
- The telescoping feature allows forward and rearward movement of the wheel.



WARNING

Make all adjustments to the steering mechanism while the vehicle is stopped. Adjusting the tilt telescoping steering wheel while the vehicle is in motion could cause loss of control and may lead to an accident resulting in death or personal injury. Failure to comply may result in death, personal

injury, equipment damage, or property damage.

Engine Brake and/or Shifter Lever

Depending on your vehicle's configuration, this lever will control engine brakes and might also have integrated transmission shifter controls.

How to Spray Windshield Washer Fluid

This vehicle is equipped with a function to wash the windshield and simultaneously engage the wipers.



CAUTION

DO NOT use antifreeze or coolant in the windshield washer reservoir. These are harmful fluids to the seals and other components. Failure to comply may result in equipment or property damage.



CAUTION

If the electric pump is operated for a long period (more than 15 seconds) with a dry reservoir, the pump motor may be damaged.

If you need to use the windshield washer:

1. Push the **Turn Signal Lever Outer Knob** in.

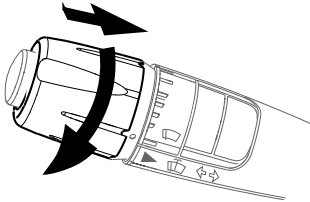

- Press and hold will activate the washer fluid and wipers.
- Instant press and release will activate the washer fluid only.

Operate the Windshield Wipers



WARNING

Clean blades regularly with a damp cloth to remove road film and wax buildup. **DO NOT** drive with worn or dirty wiper blades. They can reduce visibility, making driving hazardous which may lead to an accident. Failure to comply may result in death, personal injury, equipment damage, or property damage.

This vehicle is equipped with a two speed, intermittent windshield wiper system. The windshield wiper system is integrated with the exterior lights so that the low beam headlights will turn on when the windshield wipers turn on.

To override this function once, turn the headlights on and then off again. To permanently override this function, open the settings menu, select **Settings > Wiper Interlock** in the instrument cluster display, and select OFF.

Use washer fluid when running the wiper blades over a dry windshield to reduce the chance that the blades may scratch the

glass. Scratched windshields reduce visibility.

A seven-position rotary wiper switch (located on the turn signal lever) operates the windshield wipers and washer. If you need to use the windshield wipers:

1. Rotate the end of the turn signal lever to change the wiper mode from off to on.
2. Rotate the outer knob of the turn stalk lever to adjust the wiper speed.

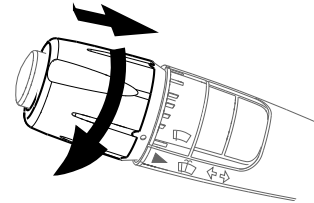

- Four levels of intermittent speeds
- Low wiper speed
- High wiper speed

Flash-to-Thank

Flash-to-thank, or “marker lights flash”, allows the operator to signal other drivers

by changing the state of the marker lights.
To activate flash-to-thank:

- Press the button at the end of the turn signal lever to invert the state of the marker lights

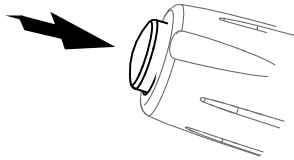

- Release the button to return to the original state of the marker lights.

Flash-to-Pass

Flash-to-pass, sometimes called “low beams flash”, allows the operator to signal other drivers. The flash looks different depending on the vehicle’s headlight type. Halogen headlamps act one of three ways based on the headlight’s initial state:

- If the low beam headlights are ON, the flash-to-pass operation will momentarily dim the headlights.
- If the low beam headlights are OFF, the flash-to-pass will turn ON

and then flash the low beam headlights.

- If the high beam headlights are ON, the flash-to-pass will turn OFF the high beams and flash the low beams.

For LED (option) and HID headlamps, the flash-to-pass operation will flash the high beams. The high beams will turn off immediately after the operation is complete. Flash-to-pass does not affect the state of HID and LED low beams. Regardless of the headlamp type, if the vehicle is using high beams, flash-to-pass will immediately deactivate the high beams. The high beams must be reactivated again after flash-to-pass is complete.

To activate flash-to-pass:

1. Push the turn signal lever away from the steering wheel.

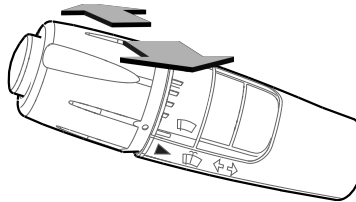

2. Release the turn signal lever to the original position.

High Beam Operation



WARNING

DO NOT use high beams in the presence of oncoming traffic. High beam glare can blind other drivers which increases the risk of an accident. Failure to comply may result in death, personal injury, equipment, or property damage.



NOTE

The high beams and flash-to-warn activation methods use the same action. To activate the high beams, turn the low beams ON. To activate flash-to-warn, turn the low beams OFF.

High beams are operated using the turn signal lever:

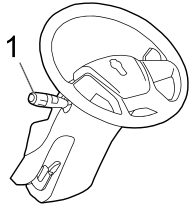

1. Turn signal lever

1. When the headlights are ON, pull the **Turn Signal** towards the operator until it clicks.

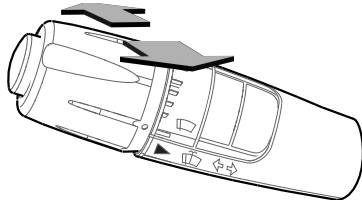

2. Release the **Turn Signal** lever to the original position. This will cycle

the headlights between low and high beam.

The blue, high beams indicator light on the instrument panel will be lit when the high beams are active.

How to Use the Turn Signal

The lever-action turn signal/high beam switch is located on the left side of the steering column. The ignition key must be turned to ON for the signal/switch to operate.



WARNING

If the vehicle turn signals and turn signal indicators in the dash gauge cluster ever begin flashing at an accelerated rate (115 cycles per minute) when the turn signal stalk is in the OFF (center) position, or when a Right/Left turn has been selected, the problem may be related to a failed turn signal switch or turn signal module. In either case, the problem is not a failed light. Contact your nearest authorized dealer to have the problem corrected as soon as possible. Failure to comply may re-

sult in death, personal injury, equipment damage, or property damage.

1. Push the **Signal stalk** lever up to engage the **RIGHT** turn signal and down to engage the **LEFT** turn signal.

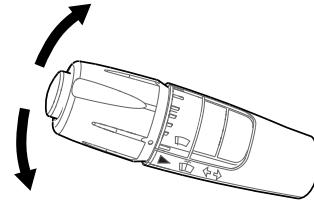

2. Release the signal stalk.
3. To cancel the turn signal, move the lever back to the middle position.

An audible beep is associated with each time a turn indicator is activated.

**WARNING**

After you complete a turn, shut the turn signal off by returning the lever to the "OFF" (center) position. Failure to shut off a turn signal could confuse other drivers and result in an accident. An indicator light in the instrument panel will flash until the turn signal is turned off. Failure to comply may result in death, personal injury, equipment damage, or property damage.

How to Adjust Tilt/Telescoping Steering Column

**WARNING**

Make all adjustments to the steering mechanism while the vehicle is stopped. Adjusting the tilt telescoping steering wheel while the vehicle is in motion could cause loss of control and may lead to an accident resulting in death or personal injury. Failure to comply may result in death, personal

injury, equipment damage, or property damage.

1. Push and hold the **Tilt/Telescoping** lever down fully.
2. Push or pull the steering wheel to the desired height and angle.
3. Push the **Tilt/Telescoping** lever back into the locked position.

Engine Brake Only Version

The lever on the right-hand side of the steering column will operate the engine brakes for the vehicle with manual transmissions or Allison automatic transmissions.

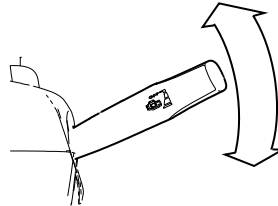

Vehicles with PACCAR or Eaton Transmissions

The vehicle may be equipped with a PACCAR or Eaton automated manual transmission. The lever on the right side of the steering column will operate transmission functions in addition to operating the engine brakes.

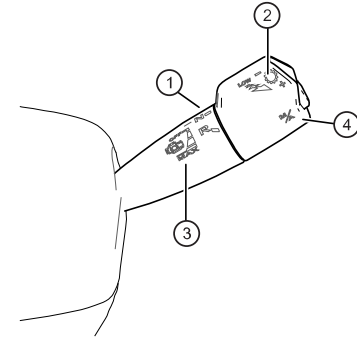





1. Transmission **D - N - R** Function
2. Up (+) and Down (-) Shift and **Low** Mode
3. Engine Brake and **Max** Mode
4. Manual (**M**)/Automatic (**A**) Mode Button







Dash Switches







This custom vehicle has a wide variety of switch-controlled equipment. It is not possible to identify every switch in this







section of the operator's manual. Some air device switches can be dependent upon the state of another device to work when switched. Some variables include: a specific vehicle speed, parking brake status, or that another device is on for the





air device to operate as expected. The instrument display shows information regarding what must change for the air device to operate as expected. The following table provides a complete list of possible switch icons:





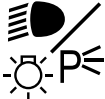

Title	Symbol	Color When Active	Std	Opt
Axle, Diff. Lock - Dual on page 110		Amber		•
Axle, Differential Lock - Tridrive on page 110		Amber		•
Axle, Diff-Lock - Forward Rear on page 110		Amber		•
Axle, Diff-Lock - Steer on page 110		Amber		•
Axle, Diff-Lock - Rear Rear on page 110		Amber		•





Title	Symbol	Color When Active	Std	Opt
<i>Axle, Diff-Lock - Single Rear</i> on page 110		Amber		•
<i>Axle, Inter-Axle Differential Locked (Tandem)</i> on page 110		Amber		•
<i>Axle, Two Speed</i> on page 111		Green		•
<i>Back Up Alarm Mute</i> on page 111		Amber		•
<i>Batteries, Low-Voltage Disconnect (LVD)</i> on page 111		None	•	
<i>Brakes, ABS Off-Road</i> on page 111		Amber		•







Title	Symbol	Color When Active	Std	Opt
<i>Brake, Parking Brake Valve</i> on page 111		Yellow	•	
<i>Brake, Trailer Hand</i> on page 111		None		•
<i>Lights, Cab Dimmer Switch</i> on page 114		None	•	
<i>Dump Truck Gate</i> on page 111		Red		•
<i>Engine Fan Override</i> on page 111		Green		•
<i>Engine, Heater</i> on page 112		Green		•
<i>Engine, Remote Throttle</i> on page 112	PUMP MODE	Amber		•

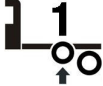

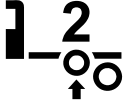

Title	Symbol	Color When Active	Std	Opt
<i>Engine, Under Hood Air Intake</i> on page 112		None		•
<i>Exhaust, Diesel Particulate Filter (DPF) Regeneration</i> on page 112		None	•	
<i>Fifth Wheel Slide</i> on page 113		Red		•
<i>Fuel Heater</i> on page 113		Amber		•
<i>Generic Air, Accessory</i> on page 113		Green		•
<i>Generic, Spare SPARE</i> on page 113	SPARE	Green		•
<i>Ignition Key Switch</i> on page 114		None	•	





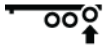
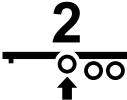

Title	Symbol	Color When Active	Std	Opt
<i>Lane Departure Warning (LDW) Disable</i> on page 114		Green		•
<i>Lights, Beacon</i> on page 114		Green		•
<i>Exterior Lighting Self-Test (ELST)</i> on page 115		None	•	
<i>Lights, Combined Headlights/Parking Lights</i> on page 115		Green	•	
<i>Lights, Daytime Running (Override)</i> on page 115		Green		•
<i>Lights, Work</i> on page 118		Green		•

Title	Symbol	Color When Active	Std	Opt
<i>Lights, Dome</i> on page 115		None	•	
<i>Lights, Flood (Spare)</i> on page 116		Green		•
<i>Lights, Fog</i> on page 116		Green		•
<i>Lights, Hazard</i> on page 117		Red	•	
<i>Lights, Marker/Clearance</i> on page 117		Green	•	
<i>Lights, Marker/Clearance/Trailer</i> on page 117		None		•
<i>Lights, Auxiliary</i> on page 114		Green	•	

Title	Symbol	Color When Active	Std	Opt
<i>Lights, Spot</i> on page 118		Green		•
<i>Power Take-off (PTO)</i> on page 118		Amber		•
<i>Power Take-off (PTO), Forward</i> on page 119		None		•
<i>Power Take-off (PTO), Rear</i> on page 119		None		•
<i>Suspension, Air Retention</i> on page 119		Amber		•
<i>Suspension, Axle, Pusher</i> on page 119		Green		•

Title	Symbol	Color When Active	Std	Opt
<i>Suspension, Axle, Tag</i> on page 119		Green		•
<i>Suspension, Dump</i> on page 119		Amber		•
<i>Trailer, Axle (3rd Axle) Lift</i> on page 120		Green		•
<i>Mud and Snow Traction Control</i> on page 118		None	•	
<i>Pintle Hook</i> on page 118		Green		•
<i>Trailer Air Supply</i> on page 120		Red	•	

Title	Symbol	Color When Active	Std	Opt
<i>Trailer, Axle (3rd Axle) Lift</i> on page 120		Green		•
<i>Trailer, Axle Lift Forward</i> on page 120		Green		•
<i>Trailer, Axle Lift Rear</i> on page 120		Green		•
<i>Trailer, Front Dump Gate</i> on page 120		Red		•
<i>Trailer, Dump Gate</i> on page 121		Red		•
<i>Trailer, Belly Dump Gate Center</i> on page 120		Red		•

Title	Symbol	Color When Active	Std	Opt
<i>Trailer, Belly Dump Gate Rear</i> on page 120		Red		•
<i>Trailer, Hotline</i> on page 121		Green		•
<i>Trailer, Suspension Air Dump</i> on page 121		Amber		•
<i>Transmission, Transfer Case</i> on page 121		Amber		•
<i>Transmission, Transfer Case Two-Speed</i> on page 121		Amber		•
<i>Winch Clutch</i> on page 121		Green		•

Axle, Diff. Lock - Dual



Turn switch on to engage Front and Rear Axle Diff Lock.

Axle, Diff-Lock - Forward Rear



Turn switch on to engage Forward Rear Axle Diff Lock.

Axle, Diff-Lock - Steer



Turn switch on to engage Front Axle Diff Lock.

Axle, Diff-Lock - Rear Rear



Turn switch on to engage Rear Rear Axle Diff Lock.

Axle, Diff-Lock - Single Rear



Turn switch on to engage Single Rear Axle Diff Lock.

Axle, Differential Lock - Tridrive



Tridrives will have these axle differential lock controls and are 2 separate switches. **FRONT** will control the forward rear and **REAR** will control the center/rear-rear axle differential. In addition, a vehicle with Tridrive will have an interaxle differential lock switch.

Axle, Inter-Axle Differential Locked (Tandem)



Turn switch on to engage Inter-Axle Differential Lock.

Axle, Two Speed

If equipped, the two speed axle switch allows you to select axle high and low ranges. The low range (Off) provides maximum torque for operating off-highway. The high range (On) is a faster ratio for highway speeds.

Back Up Alarm Mute

Turn switch on to mute Back Up Alarm.

**NOTE**

The mute function use is discouraged. Only use mute when legally required.

Batteries, Low-Voltage Disconnect (LVD)

If your vehicle is equipped with a Low-Voltage Disconnect (LVD) feature, the LVD module is located inside the driver's side kick panel.

Brakes, ABS Off-Road

Turn switch on to engage ABS Off-Road mode. See [Antilock Brake Systems \(ABS\)](#) on page 195.

Brake, Parking Brake Valve

Pull yellow knob to activate parking brake.

Brake, Trailer Hand

This dash mounted switch provides air pressure to apply the trailer brake only. It operates independently of the foot treadle valve.

Dump Truck Gate

Turn switch on to open Dump Truck Gate.

Engine Fan Override

The engine fan switch allows you to control the engine fan manually or automatically. With the ignition key switch ON and the fan switch in the MANUAL position, the engine fan will be on regardless of engine temperature. With the engine fan switch in the AUTOMATIC position, the engine fan will automatically turn on when the engine

coolant reaches a temperature of about 200°F (93°C) or when the air conditioning system has reached set point pressure. With an electronic engine, the fan may also be activated by air intake temperature, oil temperature and compression brake usage.



WARNING

DO NOT work on or near the fan with the engine running. Anyone near the engine fan when it turns on could be injured. If it is set at MANUAL, the fan will turn on any time the ignition key switch is turned to the ON position. In AUTO, it could engage suddenly without warning. Before turning on the ignition or switching from AUTO to MANUAL, be sure no workers are near the fan. Failure to comply may result in death or personal injury.



CAUTION

The fan or equipment near it could be damaged if the fan turns on suddenly when you do not expect it. Keep all tools and equipment away from the

fan. Failure to comply may result in equipment or property damage.



CAUTION

DO NOT operate the engine fan in the MANUAL position for extended periods of time. The fan hub was designed for intermittent operation. Sustained operation will shorten the fan hub's service life as well as reduce fuel economy. Failure to comply may result in equipment or property damage.

Engine, Heater



Turn switch on to activate the Engine Heater.

Engine, Under Hood Air Intake

This switch opens a door in the engine air filter housing. This action allows intake of air from under the hood instead of outside air. This switch can be useful when starting the vehicle in cold-weather conditions.



CAUTION

Only operate the under hood intake air switch when outside temperatures are below 32°F (0°C). Engaging the under hood air intake while temperatures are above freezing may result in engine damage.

Engine, Remote Throttle

**PUMP
MODE**

Turn switch on to activate Remote Throttle Control.

**Exhaust, Diesel Particulate Filter
(DPF) Regeneration**



Manually controls the diesel particulate filter (DPF) regeneration process. Refer to Engine Aftertreatment Controls Operator's Manual for additional information.

Fifth Wheel Slide



Turn switch on to unlock Fifth Wheel Slide mechanism. The switch is guarded to protect you from accidentally activating or releasing the lock.



WARNING

DO NOT move the fifth wheel while the tractor-trailer is in motion. Your load could shift suddenly, causing you to lose control of the vehicle. Never operate the vehicle with the switch in the UNLOCK position. Always inspect the fifth wheel after you lock the switch to be sure the fifth wheel slide lock is engaged. Failure to comply may result in death, personal injury, equipment or property damage.



NOTE

Vehicles having an air slide fifth wheel have a fifth wheel slider lock controlled by a switch on the instrument panel. By placing the switch in the unlock position you can slide the fifth wheel to various positions to adjust weight distribution.

Fuel Heater



Turn switch on to activate Fuel Heater.

Generic Air, Accessory



Provides accessory air to the end of the frame connection when switch is turned on.



NOTE

The generic air accessory switch is designed by the original equipment manufacturer to reset when the ignition power is turned off. When ignition is turned off, this circuit will exhaust air pressure.



NOTE

The generic air accessory switch is designed by the original equipment manufacturer to reset when the start switch power is turned off. When start switch is turned off, this circuit will exhaust air pressure.

Generic, Spare SPARE SPARE

Turn switch on to power customer installed accessory.

Ignition Key Switch

The ignition key switch located to the left of the steering column has four positions: ACC (Accessories), OFF, ON, and START.



OFF: In this position all accessories are OFF (except those listed below) and you can remove the key.

The following lights and accessories have power when the key is in the OFF position:

- brake lights
- emergency hazard flasher
- dome and courtesy lamps (on doors)
- city horn
- cigarette lighter
- tail lights
- marker lamps
- headlights
- radio station memory
- instrument lights
- auxiliary power
- instrument panel memory settings

ACC (Accessory): With the key in this position you can play the radio, defrost mirrors (if equipped with mirror heat) or use other accessories.

ON: In the ON position all circuits are energized. Panel warning lights will light and the buzzer will sound until (1) the engine is started, (2) normal oil operating pressure is reached, and (3) air brake system pressure is above 65 psi (441 kPa). In this position, the ignition key cannot be removed.

START: Turn the key to this position to start your engine. Release the key after the engine has started.

Lane Departure Warning (LDW) Disable



The Lane Departure Warning (LDW) Disable switch disables both audible and visual Lane Departure Warning alerts for 15 minutes (or until the next ignition key cycle) after which time LDW will automatically re-enable. This switch will not

affect any audible or visual alerts for the Adaptive Cruise Control (ACC) feature. This switch lights up green when active.

Lights, Auxiliary



Turn switch on for Auxiliary Lights.

Lights, Beacon



Turn switch on for Beacon Light(s). In Medium Duty two types of switches are optioned: a traditional rocker switch and a push button over on the left panel.

Lights, Cab Dimmer Switch



This switch is used to alter the brightness of the instrument panel lights.

**NOTE**

The Headlight Switch is an ON or OFF switch. The panel lights are on full intensity during the day and dim when headlights are on.

Lights, Combined Headlights/ Parking Lights

Lights, Daytime Running (Override)



This switch overrides the normal operation of the Day Time Running Light (DRL) system. During normal operation, the DRL turns on lights when the headlights are turned off, engine is on, and the park brakes are disengaged. The override switch turns the DRL off in these instances. The DRL is also turned off when the headlights are turned ON.

**WARNING**

DO NOT use daytime running lights (DRL) during periods of darkness or reduced visibility. DO NOT use DRL as a substitute for headlights or other lights during operations that require lighting of your vehicle. Failure to comply may result in personal injury, property damage or death.

If the headlight switch is turned OFF, the DRL system engages automatically after the engine starts and you release the parking brake. If the headlight switch is ON, the DRL system is overridden, and headlights operate normally. Also, the DRL is temporarily turned off during engine cranking.

Lights, Dome



Turn switch on for Cab Dome Lights.

Exterior Lighting Self-Test (ELST)



The Exterior Lighting Self-Test (ELST) allows the operator to examine all exterior lights as part of a pre-trip inspection. An ELST can be activated via the dash switch or the key fob. A full ELST can only be activated with the ignition switch in the ON position; otherwise, a limited ELST is performed.

The ELST will run for fifteen minutes. Exterior light functionality can be verified by watching the lights from outside the vehicle and by reading the instrument cluster for displayed faults. The operator may interrupt the test by turning the vehicle off or activating the switch a second time while the test is running. The ELST will also start the system check ([Systems Check](#) on page 37).

Full ELST

When a full ELST is activated, it will alternately turn on and then off the following lights:

- Park lights

- License plate lights
- Hazard/turn signals
- Low beam headlights
- High beam headlights
- First set of fog/driving lights
- Tail lights
- Stop lights
- Reverse lights
- Fog lights (option)
- Driving lights (option)
- Daytime Running Lights (option)

The following lights stay on during the duration of a full test:

- Clearance lights
- Identification lights
- Side Marker lights
- Beacon/Strobe (option)
- Work/Load lights (option)
- Sign light (option)

Limited ELST

A limited ELST will alternately turn on and then off the following lights:

- Hazard/turn signals
- Low beam headlights
- High beam headlights
- Park lights
- Daytime running lights (option)

- License plate lights
- Tail lights
- Stop lights

The following lights will stay on during the duration of a limited test:

- Clearance lights
- Identification lights
- Side marker lights

Test the Exterior Lights

To start the Exterior Light Self Test (ELST) feature:

1. Park the vehicle and set the parking brake.
2. Insert the key into the ignition and turn the key to the ON position. Allow the vehicle to run through bulb check.
3. Press the momentary switch on the dash to start the ELST.



Lights, Flood (Spare)



Turn switch on for trailer mounted Flood Lights.

Lights, Fog



Turn switch on for Fog Lights.



NOTE

Fog lights should be used in the presence of fog, rain, dust, snow, or smoke. Do not use during general operation because this is illegal in some locations.

**NOTE**

Across the U.S.A. and Canada, State/ Provincial requirements vary as to when high beams and fog lights can and cannot be used together. Some states allow only four lights to be used together, while some allow more. How your lights are arranged will affect whether you can operate headlights and fog lights concurrently always comply with the state or provincial requirements where you are driving.

Lights, Hazard

This switch operates the emergency flashers. With the switch in the ON position, the emergency flasher makes all four turn signals (front and rear) flash simultaneously. The flasher works independently of the start switch. You should always use the flasher if the vehicle is disabled or parked under emergency conditions.

Y53-1200-1L1 (05/2024)

**WARNING**

Be aware of all governing Hazard Warning Light laws and keep all necessary emergency signals in the vehicle per FMCSR 392.22. During unusual or emergency situations, use all relevant lights and signals since hard-to-see vehicles can increase the risk of accidents. Failure to comply may result in death, personal injury, equipment damage, or property damage.

Lights, Marker/Clearance

Turn switch on to control Cab and Vehicle Marker/Clearance lights.

**NOTE**

An interrupt switch for the trailer marker lights is mounted on the end of the turn signal lever.

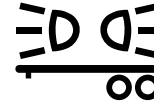
Lights, Marker/Clearance/Trailer

Turn switch on to control trailer marker/clearance lights separately from the vehicle marker/clearance lights.

Lights, Park Light

Turn switch on for Park Lights. When the Park Lights are on the dash lights, side and tail lights are also on.

Lights, Sleeper Dome (option)



Turn switch on to activate the sleeper dome lights.

Lights, Spot



Turn switch on for Spot Light.

Lights, Work



Turn switch on for cab mounted Flood Lights. Switches 1 and 2 are push buttons, but 3 is a rocker switch.

Mud and Snow Traction Control



Momentarily push switch in to engage Traction Control (TC).

Pintle Hook



Turn switch on to remove the slack from the hook.

Power Take-off (PTO)



This vehicle may be equipped with a dash-mounted switch that controls PTO engagement/disengagement. When the operator activates the switch for the PTO,

the status indicator light (located on the switch) will immediately illuminate even though PTO engagement may not have occurred. If the PTO is engaged and the operator turns the switch **OFF**, the PTO status indicator light (located on the switch) will turn off immediately even though PTO disengagement may not have occurred.

 CAUTION
<p>Increasing engine rpm before the PTO is active can prevent the PTO from engaging and/or cause PTO damage.</p>

 NOTE
<p>The PTO cannot engage instantly. There is a slight delay.</p>

 NOTE
<p>Actual PTO status may be indicated on dash display depending on vehicle configuration.</p>

Power Take-off (PTO), Forward

Your vehicle may be equipped with a dash mounted switch that controls forward PTO engagement/disengagement.

Power Take-off (PTO), Rear

Your vehicle may be equipped with a dash mounted switch that controls the rear PTO engagement/disengagement.

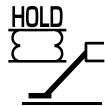
Suspension, Air Retention**Suspension, Axle, Pusher**

Turn switch on to lower Single or Forward Pusher Axle.

Suspension, Axle, Tag

Turn switch on to lower tag axle.

Suspension, Dump

Turn switch on to deflate suspension air bags. The switch is guarded to protect you from accidentally deflating the suspension.

**WARNING**

DO NOT operate the Air Suspension Deflate Switch (Dump Valve) while driving. Sudden deflation while your vehicle is moving can affect handling and control and could lead to an accident. Use this switch only when your vehicle is not moving. Failure to comply may result in death, personal injury, property damage, or equipment damage.

**CAUTION**

Operating a vehicle with air suspension bags either overinflated or underinflated may cause damage to drive-line components. If a vehicle must be operated under such conditions, do not exceed 5 mph (8 km/h). Failure to comply may result in equipment damage.

Suspension, Third Axle Lift



Turn switch on to raise Third Axle.

Torque Assisted Steering Effort Adjustment



Three-position switch that adjusts how much steering assistance is provided for vehicles equipped with Torque Assisted Steering.

The top position provides the most assistance (requiring the operator to exert less effort to turn the wheel), the middle position moderate assistance, and the bottom position the least amount of steering assistance (requiring more effort to turn the wheel than the top and middle positions).

Trailer Air Supply



The red octagonal knob controls the air supply to the trailer.

Trailer, Axle (3rd Axle) Lift



Turn switch ON to lift 3rd Trailer Axle.

Trailer, Axle Lift Forward



Turn switch on to lift Forward Trailer Axle.

Trailer, Axle Lift Rear



Turn switch on to lift Rear Trailer Axle.

Trailer, Belly Dump Gate Center



Turn switch on to open Trailer Center Belly Dump Gate.

Trailer, Front Dump Gate



Turn switch on to open Trailer Front Belly Dump Gate.

Trailer, Belly Dump Gate Rear



Turn switch on to open Trailer Rear Belly Dump Gate.

Trailer, Dump Gate



Turn switch on to open Trailer Dump Gate.

Trailer, Hotline



Turn switch on to supply electrical power to trailer accessories.

Trailer, Suspension Air Dump

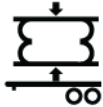

Turn switch on to deflate trailer air suspension.

Transmission, Transfer Case



Turn switch on to shift the transfer case.

Transmission, Transfer Case Two-Speed



Turn switch on to shift the two-speed transfer case.

Winch Clutch



Turn switch on to engage winch clutch.

Door-Mounted Mirror Controls

The vehicle can have power mirrors. If so, the mirror controls are on the driver-side door pad. You can adjust mirrors in four directions. To provide good visibility, adjust the mirror so the side of the vehicle appears in the inboard part of the mirror.

NOTE

The vehicle can come with a digital side-view mirror option. Refer to the PACCAR Digital Vision System with Mirrors operator's manual for instructions. This manual is in the glove box.

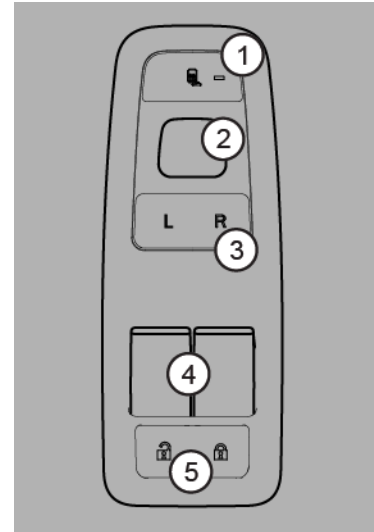

1. Mirror heat
2. Mirrors adjust
3. Left or right mirror adjustment selector
4. Window controls
5. Door lock control

Power Mirror Switch

If the vehicle comes with power mirrors, the directional controls for both mirrors are on the top of the driver-side door.

Power Door Lock Switch

Power door lock rocker switches are on the door pads. To toggle all door locks simultaneously, press any door lock switch marked with a padlock symbol.

Power Window Switch

Power window rocker switches are on the door pads. Depress the switch to open the window. Pull up on the switch to close the window. Release the switch to stop window movement. The driver-side window has an express down feature. Holding the switch down activates the express down feature. Release the button and the window descends until it is fully open.

How To Use Power Mirror Adjustment Switches



WARNING

Adjust all mirrors before driving. Adjusting the mirrors while driving could result in an accident. Failure to comply may result in death, personal injury, equipment damage, or property damage.



WARNING

Convex mirrors can distort images and make objects appear smaller and farther away than they really are. You could have an accident if you are too close to another vehicle or other object. Keep plenty of space between the vehicle and others when you turn, or change lanes. Remember that other objects are closer than a bubble-mirror displays them.

1. Move the **Mirror Selector** switch (3) to the right or left to select the desired mirror for adjustment.

2. Depress the **Mirror Directional Control** pad (2) in one of its four arrow directions. The mirror moves in that direction.
3. Adjust the mirror so the side of the vehicle appears in the inboard part of the mirror.
4. When you are finished with adjustments, return the **Mirror Selector** switch back (3) to the center (neutral) position. This step prevents unintentional adjustments to the mirrors.

Digital Mirror System

The PACCAR Digital Mirror System (DM) is a camera-based mirror enhancement solution intended to work WITH aerodynamically improved traditional mirrors, providing a familiar, natural driving experience. The PACCAR DM system enhances both direct vision and night vision, while reducing aerodynamic drag.

**WARNING**

The driver is always responsible for safely operating the vehicle. If the DM system fails, use the traditional mirrors to maneuver the vehicle and seek service immediately. Failure to comply

may lead to property damage, personal injury, or death.

**WARNING**

The driver is always responsible for safely operating the vehicle. Change DM system settings only when it is absolutely safe to do so. In the event of a DM system failure, use the traditional

mirrors to maneuver the vehicle only when deemed safe to do so and seek service immediately. Failure to comply may lead to property damage, personal injury, or death.

Components

DM Components

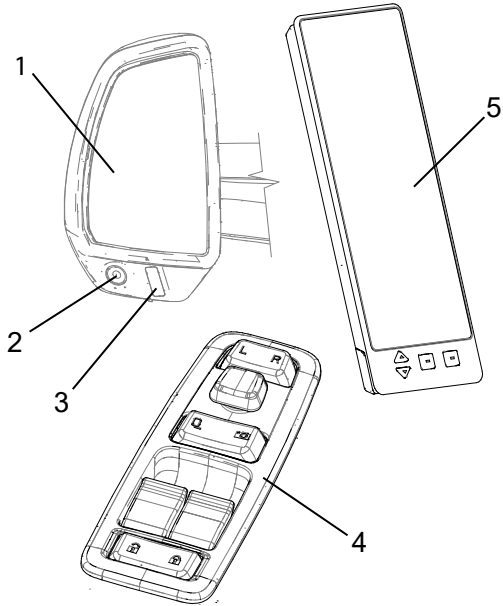

1. Compact Aero Mirror
2. Camera
3. Infrared Lamp
4. Door Mounted Control Module (driver's side only)
5. Digital Mirror Display

i NOTE

Heater Switch for Glass Mirror and Camera Lens is not shown. It is dash-mounted and location may vary depending on vehicle model.

DM/DVS-M Controls

DM Controls

Driver's Side Digital Camera Display

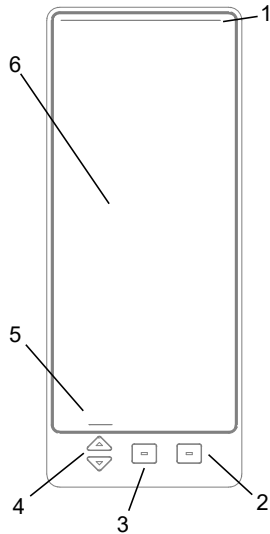

Driver's Side Door Control Module

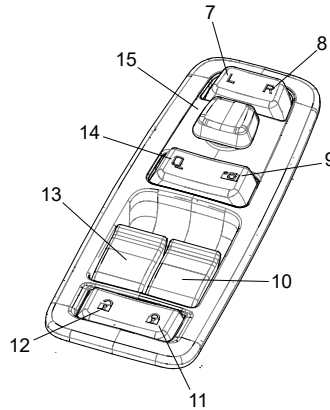

1. Camera pan-angle indicator bar
2. Multi-Function. View-Type cycle, Back, or Menu-Exit
3. Dual Function. Night Vision OR menu access. (NOTE: Menu will only show when the PARKING BRAKE is engaged.)
4. Dual Function. Brightness or menu scroll
5. Soft key label area
6. Main display field for camera feed(s)
7. Left side selector
8. Right side selector
9. Digital Mirror selector
10. Right window up/down switch
11. Electric door lock
12. Electric door unlock
13. Left window up/down switch
14. Traditional glass mirror selector
15. Mode-dependent joystick

Enabling the DM

The DM will turn on temporarily when the vehicle is unlocked with the vehicle key fob, OR when the door is opened if it is already unlocked. After two minutes the system will go into a sleep-state *unless* the operator turns the ignition key to the ON position OR presses on the *door control module*, the joystick (15), digital mirror selector (9), unlock (12) OR any button on the *display* controls. If the ignition is shut off, the system will again wait two minutes before going to sleep.

NOTE

The joystick will not wake the DM when the controls lockout is engaged, or when traditional glass mirrors are selected on the controller (14).

NOTE

The DM displays will actively display while the key is in the on position and cannot be shut off.

NOTE

System settings will default to most of those that were active prior to a system power-down (key off).

NOTE

The last user selected view-type is saved before the system enters deep sleep. Deep sleep is activated after 7 minutes of inactivity. After 7 minutes, or battery disconnect, it will revert to the default view-type.

WARNING

Adjust all mirrors before driving. Adjusting the mirrors while driving could result in an accident. Failure to comply may result in death, personal injury, equipment damage, or property damage.

Initial Set Up

Language Selection

The DM has three languages to choose from: English, Spanish, and French.

NOTE

Language selection is found in the menu which can only be accessed with the parking BRAKE ENGAGED.

To change the language

1. **Select the Digital Mirrors** – press (9).
2. **Select the Menu** – press (3).
3. **Navigate to Language** – press (4) until the Language line is highlighted.
4. **Cycle to the desired option** (English, Spanish, or French) – press (3).
5. Either continue to navigate to other settings if desired, or press the back button (labeled on screen).



NOTE

Language selection in the Digital Mirrors is independent from language selection in the Digital Display. Separate procedures must be followed for each system.



NOTE

Throughout this manual, the numbers shown in parentheses (X) in instructions refer to a specific DM control button. The *location* of a button is shown in the figures found in *DM/DVS-M Controls* on page 125.

3

Digital Mirrors Not Selected



The “Digital Mirrors Not Selected” icon will appear on the Digital Mirror Display to indicate that the Traditional Glass Mirrors selector button (14) (see *DM/DVS-M Controls* on page 125) OR if controls lockout is active on the door control module. To use the door control module or monitor buttons to control the Digital Mirrors, ensure the Digital Mirror selector (9) has been selected.

Selecting View-Types

The DM uses three View-Types to present what its cameras see.

- **Expanded View Type - (only available on passenger side display)** - Two views are displayed. An upper, larger portion of the display is a panoramic view, while the lower is a look-down view of the passenger side front wheel area.
- **Traditional View-Type** - The upper and largest area of the display shows an image similar to that of a traditional flat-glass, physical mirror, while a lower, smaller portion shows a view similar to a convex bubble mirror.

- **Panoramic View-Type** - Fills the entire display and has some of the characteristics of a traditional convex "bubble" mirror.



WARNING

Do not use panoramic view to judge distance or clearances between objects. The panoramic view is only intended to show you that an object is present, and it's general direction relative to your vehicle. When using panoramic view, exercise the same caution you would use with a glass convex (bubble) mirror. Failure to comply may result in property damage, personal injury, or death.

Refer to the figures in the *DM/DVS-M Controls* on page 125. The numerals shown in parenthesis (X) in the following instructions correlate to the numbered buttons shown there.

To change View Types:

1. **Select the Digital Mirrors (general)** - Press (9)
2. **Select which side** Digital Mirror you would like to change settings for - Press (7) or (8) until the

desired display is bordered by *green*.



NOTE

Whenever the *Digital Mirrors* are selected, a green border will appear around the perimeter of one display, while a red border will appear around the other. A *green* border indicates that a display is ready to accept settings changes. A red perimeter indicates a display that *cannot* receive changes. You may toggle the left and right side selector buttons to change the 'ready' monitor as needed.

3. **Change the current View-Type** - press (2) until the desired View-Type appears on the display.

Set Trailer End Line

The DM places a line on screen that provides the ability to visually locate the end of the trailer quickly. Because overall combination vehicle lengths can vary, this line position is user adjustable. The line

must be adjusted each time the overall vehicle length changes.



NOTE

Trailer End Line Adjustments are found in the menu which can only be accessed with the PARKING BRAKE ENGAGED.



NOTE

Placing a physical object for reference - like a traffic cone or triangle - at the end of the trailer can make the on-screen adjustment of the end line significantly easier.

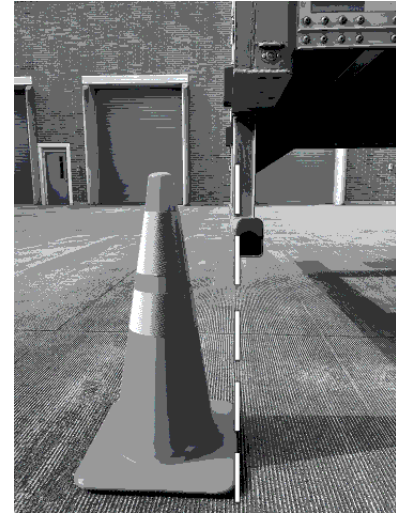

To Set Trailer End Line through the menu, with **Parking BRAKE ENGAGED**
Enter the menu – press (3).
Navigate to Set Trailer End Line – press (4) until Set Trailer End Line is highlighted.
Enter Set Trailer End Line – press (3).
Locate the line to end of trailer – press (4) until the line is aligned with the end of trailer reference object.



NOTE

BEST PRACTICE is to position top of the trailer end line at the base of the reference object.

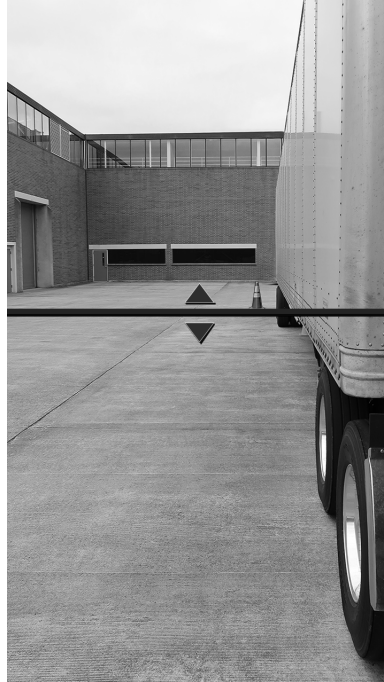

Record the new end line position - press (3).

The system then returns to the root menu. If no other system changes are desired, the user can then

Exit the menu- press (2).

The system returns to the previous view-type, and is ready for use.

The DM will also automatically detect when an electrical truck-to-trailer connection is made, and inform the operator with the following on-screen message:

Trailer Detected. Is Trailer End Line correct?

The choices are

- **Yes**

or

- **Adjust**

If "Yes" is selected, the pop-up message disappears, and the system returns to the last active view mode and is ready for driving.

If "Adjust" is selected, the end-line adjustment screen goes active, and the user is then permitted to set the end line using a guided process.

Distance Lines



WARNING

Trailer end line, and corresponding distance lines, are dependent upon your calibrations in the menu. The trailer end line must be reset when adjusting king pin settings or using a different trailer. Failure to comply may result in death, personal injury, or property damage.



WARNING

Distance line values are approximate and vary depending on the topography surrounding the vehicle. Do not rely solely on distance line values to determine the specific distance to surrounding objects. Ultimate responsibility for the safe operation of the vehicle remains with the driver at all times. Failure to comply may result in death, personal injury, or property damage.

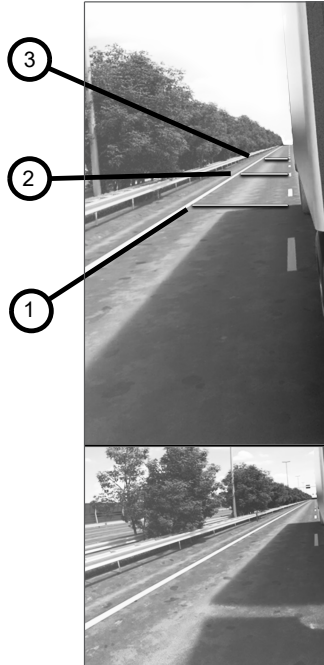

1. Trailer End Line
2. First Distance Line
3. Second Distance Line

The DM also gives the option to use preset distance lines that accompany the trailer end line, which can be enabled through the menu.

In forward gear, the first distance line represents approximately 40 ft behind the trailer end line, and the second distance line represents approximately 80 ft behind the trailer end line.

In reverse gear, the first line represents approximately 10 ft behind the trailer end line and the second line represents approximately 20 ft behind the trailer end line.

These distance lines move with the trailer end line as it is adjusted but remain a set distances away from it, as specified above.

Left/Right (L/R) Endline Calibration

The L/R End Line Calibration is completed at the factory. While the calibration settings can be accessed by the operator, calibrating the system is unnecessary and

SHOULD NOT be done *unless* a *Digital* mirror is replaced or repaired.



WARNING

If any external damage occurs, or if a traditional glass mirror is *replaced*, the L/R End Line Calibration **MUST** be performed before operating the vehicle. Failure to comply may result in property damage, physical injury, or death.

L/R Endline Calibration Instructions:

1. Set up a marker on the ground that is 10.2 meters behind the center of the front axle.
2. Navigate to the Menu (3) on the Digital Mirrors, then select "Set Trailer End Line".
3. To then enter the L/R End Line Calibration Mode:
 - With the **Parking Brake Engaged** and the Door Control Module set to Digital Mirror selector (9) and Right-side selector (8), press and hold the middle button (3) on the digital mirror display for 5 seconds. Passenger Side (PS) & Driver

4. Side (DS) trailer end lines will now move independently.
4. Using the arrow buttons (4), direct the top of PS end line to the 10.2-meter mark on the ground. A green box on the display will indicate that the PS is active.
5. Use the DCM to switch to Left side selector (7) and direct the top of the DS end line to the 10.2-meter mark. A green box on the display will indicate that the DS is active.
6. Once both lines are set to the 10.2-meter mark, select the middle button (3) on the digital mirror display to confirm and exit the calibration mode.
7. Follow "Set Trailer End Line" procedure to set calibrated trailer end lines to the desired end of trailer location.



NOTE

When the calibrated lines are confirmed and the calibration mode is exited, the lines will jump above the 10.2-meter mark to their default location.

Trailer End Lines will remain at same position relative to each other.

Manual Camera Panning

Manual panning can be useful for reviewing specific objects that are outside the default panning angle. Both left and right-side cameras can be manually panned independently of one another.



NOTE

Panning is not available in every View-Type. IF panning is available in the current View-Type, panning direction bar(s) will appear on the top and/or edge of the screen when the joystick (15) is used.

To activate manual panning:

1. Select Digital Mirrors - press (9).
2. Select the side you would like to change settings for. (The desired Digital Mirror Display must be bordered by green to accept changes.) - press (7) or (8) settings.

- Direct the view of the camera (AKA, "pan") as desired with the joystick (15). Panning bar(s) will appear and move as the camera is panned.
- To **save** the camera panning angle - press directly down on the joystick (15).



- To leave the camera panning angle **unsaved** – do not press down on the joystick (15).

NOTE

SAVED PANNING ANGLE TIMEOUT - A saved manual pan will persist indefinitely unless a new manual camera pan is saved. The opportunity to save a manual pan will be

available for 45 seconds when vehicle speed is below 25 mph and 10 seconds when vehicle speed is above 25 mph. A save icon will appear on the Digital Mirror Display during this time.

NOTE

Unsaved Panning Angle Timeout - An unsaved manual pan made when the vehicle speed is under 25 mph will persist indefinitely. However, if the vehicle speed then increases above 25 mph it will immediately revert to the default panning angle. An unsaved manual pan made over 25 mph will only persist for 10 seconds then revert to the default panning angle.

Display Settings

NOTE

To make changes to Digital Mirror Display settings, you must first select one, and only one, of the Digital Mirrors Displays.

- Select the Digital Mirror** (as opposed to the Traditional Glass Mirror) - press (9)
- Select which side** Digital Mirror you would like to change settings for - press (7) or (8).

NOTE

Panning Bars may appear on the top and side of the Digital Mirror Displays, and a green border will appear around the selected Digital Mirror Display to indicate it alone is ready to accept settings. A Digital Mirror Display with a RED border cannot accept settings changes.

Night Vision

Night Vision is intended to increase object visibility in a variety of low-light settings. These include, but are not limited to; dusk, dawn, overcast, night, or when passing through tunnels and poorly-lit warehouses. When activated, Night Vision creates an infrared enhanced rendering of the camera feeds.

There are three Night Vision settings

- ON
- OFF
- AUTO

To cycle through these settings - with the PARKING BRAKE RELEASED

1. Repeatedly press (3) on the driver's side Digital Camera Display until you achieve the desired night vision setting. The current setting state will show on the display.

To change Night Vision settings through the menu - with the PARKING BRAKE ENGAGED

1. **Access the menu** - press (3).
2. **Navigate to Night Vision** - press (4) until Night Vision line is highlighted.
3. **Cycle to the desired option** (ON, OFF or AUTO) - press (3).
4. Either continue to navigate to other settings if desired or press the back

button (labeled on screen). Pressing the back buttons saves the selected settings.

 **NOTE**

The "look down" camera does not use Night Vision and may appear darker at night.

Adjust Display Brightness

 **NOTE**

The Digital Mirror Display brightness levels will always change automatically - regardless of user settings - with a change in ambient light level (transitioning from a tunnel to daylight, for example). This feature cannot be shut off.

 **NOTE**

Even though the system will always continually adjust display brightnesses, user brightness adjustments are

necessary when a driver first uses the DM, and occasionally thereafter. The driver **SHOULD** adjust brightness **WHENEVER** they feel it will improve the Digital Camera Display visibility.

 **NOTE**

Your left and right displays brightness levels can and will change independent of one another based on ambient lighting levels.

The system records a driver's screen brightness settings along with the ambient lighting at the time of the adjustment. When the system sees the same ambient lighting in the future, it will automatically adjust the *display brightness* to match the recorded display brightness for that ambient (AKA, "outside") light level. The goal of this system is to reach a state where driver brightness adjustments are mostly unnecessary.

To adjust the display brightness

1. **Select the Digital Mirror Display** - press (3).

2. **Select which side** Digital Mirror Display you would like to change settings for - press (7) or (8).
3. **Adjust display brightness** to the desired level - use the up or down arrows (4).
4. **Return the Digital/Glass Camera selector switch** to the controls lockout position.

Traditional Glass Mirror Adjustment



WARNING

Adjust all mirrors before driving. Adjusting the mirrors while driving could result in an accident. Failure to comply may result in death, personal injury, equipment damage, or property damage.



NOTE

The Mirror-Type Selector (Digital/Glass) found on the Door Control Module is a 3 position switch. The center position is unlabeled and deactivates the vehicle side selector, and joystick.

After intentional adjustments, return the switch to the controls lockout position.

Use the following steps to adjust the vehicle's traditional glass mirrors:

1. **Select the Traditional Glass Mirror** - press (14). The joystick will now adjust the glass mirrors, but have no effect on the *Digital Mirror* settings.
2. **Select which side** Traditional Glass Mirror you would like to adjust - press (7) or (8).
3. **Adjust the mirror** - use the joystick (15).
4. **Repeat these steps** for the opposite mirror if necessary.
5. **Return the Camera Type Selector switch** back to the controls lockout position to prevent unintentional adjustments to the mirrors.

Trailer Tracking

This feature continuously adjusts a camera's angle to keep the end of a trailer in view while the vehicle is turning.



WARNING

Vehicles towing MULTIPLE TRAILERS may not fully benefit from the Trailer Tracking feature. The camera panning angle-limits may not allow the camera to see the end of the rear-most trailer. Do not use trailer tracking feature with multiple trailers. Failure to comply may result in property damage, physical injury, or death.



WARNING

Due to limitations in the Infrared Lamp (3), Reverse Trailer Tracking does not function in low light conditions. When in low light conditions with Night Vision OFF, TURN TRAILER TRACKING TO FWD ONLY and use the traditional glass mirrors while backing. If Night Vision is set to AUTO or ON, reverse trailer tracking is automatically disabled in low light conditions. Failure to comply may result in property damage, physical injury, or death.

Trailer Tracking can be activated or deactivated in the settings menu. To toggle

the state, first make certain that the PARKING BRAKE IS ENGAGED, then

1. **Select the Digital Mirrors** - press (9).
2. **Select the Menu** - press (3)
3. **Select "Trailer Tracking"** - press either arrow found at (4) on the Digital Camera Display until "Trailer Tracking" is highlighted.
4. **Toggle "Trailer Tracking" to FWD ONLY, FWD/REV or OFF** – repeatedly press (3) until the desired state (FWD ONLY, FWD/REV, OFF) is selected.
5. **Exit the menu** - press (2).

The FWD ONLY setting activates forward trailer tracking, disabling reverse. The FWD/REV setting activates both forward and reverse trailer tracking. The OFF setting deactivates all trailer tracking. The system will retain user selection of FWD ONLY or FWD/REV over key and battery cycle when a trailer is detected.



WARNING

Reverse trailer tracking may reduce rearward visibility based on tractor and/or trailer set up. If camera panning

is unable to follow the end of the trailer while set to FWD/REV, disable reverse trailer tracking by changing the setting to FWD ONLY. Failure to comply may result in property damage, physical injury, or death.

When operating an un-coupled tractor (AKA, "Bob-tailing") the Trailer Tracking feature will revert to a 'paused' state until it again detects a truck-to-trailer, electrical connection. This feature is on by default, but can be switched completely off in the Settings Menu.

Side Object Detection (SOD)



On vehicles optioned with driver side SOD, and that are also equipped with Digital Mirrors, when an object is detected by SOD on the *driver's side* there will be a

continuous visual indication on the *driver side* Digital Mirror display. On vehicles optioned with passenger side SOD and Digital Mirrors, when an object is detected by the *passenger side* SOD function, there will be a continuous visual indication on the *passenger side* Digital Mirror display.

Cold Weather Operation and Lens Heating

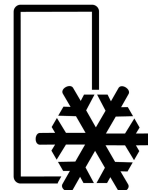

**WARNING**

The Digital Mirror displays may have an extreme delay (latency) that makes the system **UNSAFE FOR USE** if the cab interior temperature is below 14°F (-10°C). There is **NO AUDIBLE WARNING** for low-temperature, system latency. Allow the cab interior to warm to above 14°F (-10°C) before travel. Failure to comply may result in death, personal injury, or property damage.

**WARNING**

Icing, condensation, or other substances can reduce or completely obstruct the camera's field-of-view. Remove any form of blockage from the camera **BEFORE MOVING THE VEHICLE**. Failure to comply may result in property damage, personal injury, or death.

In cold or inclement weather, make certain the camera's field of view is clear of snow, ice, or condensation **BEFORE MOVING THE VEHICLE**. If the camera lens is blocked by ice or condensation, first

determine if the lens heater has turned on automatically. If it has not, activate the heater manually, and then wait until the lens is clear before driving.

**NOTE**

The lens heater switch will be dash mounted, and varies by truck model, optioning and configuration. Refer to your general truck operator's manual, or contact your dealership if you need assistance in locating it.

You may wipe *condensation* away from the lens with a soft cloth, but depending on weather conditions it may return almost immediately. The lens heater will provide continuous protection from ice and condensation.

**CAUTION**

DO NOT SCRAPE ice from the camera lens. **DO NOT USE** chemical deicers on the mirror or camera lens. Use the mirror heater function to remove ice or condensation from the lens. Failure to comply can result in non-warrantable equipment damage.

Caring for the DM System**CAUTION**

There are no user-serviceable components in the DM system. **DO NOT** attempt to repair or replace the DM system. PACCAR Inc. is not responsible for liability arising from unauthorized repair, modifications or misuse of the DM system. Do not attempt to service the Digital Mirrors. Failure to comply may result in property damage, physical injury, or death.



CAUTION

DO NOT allow direct jet wash or abrasive cleaners to be applied to the lenses of your DM cameras or infrared modules. Failure to comply may result in non-warrantable equipment damage.



NOTE

If you notice a "halo effect" wipe the camera lens with a damp microfiber cloth. If condition remains, contact your nearest dealer.

Use Normal Truck Wash:

- Request no direct jet wash to cameras
- No additional care needed
- Standing water drop will dry after short time driving or can be gently wiped away with a clean microfiber towel (to prevent scratching to plastic camera lense)
- If you notice soap standing on the lens after a truck wash, gently wipe

the lens dry with a damp microfiber towel

Pre-trip Inspection:

- Visually inspect mirror arms and cameras for damage
- Visually inspect all Digital Camera Displays for damage
- Press the door unlock button and wait for system to power up
- Inspect to see if any red status indicators are visible that would indicate a system issue
- Check to see if the trailer is visible on both Digital Camera Displays, and that an image is present from the look-down camera
- Check to see a clear image in all monitors

Monitor At Dusk 'blue/purple effect'

During periods of low light, such as at dawn or dusk, the system may show a blue or purple effect on the Digital Mirror Displays. This phenomenon is created by specific frequencies of light interacting with the cameras and does not indicate a problem with the system. This is not a permanent effect and it will go away shortly

after it appears, as the sun continues to rise or set.

System Fault Alerts



There are multiple types of faults that can occur in the DM system. When this happens a fault symbol will show both on the driver's side display, AND on the digital instrument display in the dashboard. The *in-dash* message may or may not instruct the operator what to do to address it.

1. **General Fault** - The system has a fault that may not be immediately noticeable by the driver.

2. **Latency Fault** - The system isn't displaying images in real time (delay of at least 0.5 seconds), which may be difficult for a driver to notice.
3. **Light sensor is blocked** - The system can't display the appropriate screen brightness level if the sensors are covered.

Heating and Air Conditioning (AC)

This vehicle's heating and air conditioning (AC) system operates in four distinct modes: manual, automatic, semi-automatic and, maximum defrost. Each mode provides the driver with the greatest level of comfort and convenience.

The recommended mode for all conditions that do not require windshield defrosting is the automatic mode. Automatic mode maintains cab comfort under various driving conditions without driver interaction. The cab heater and air conditioner controls sit together in the center of the dash. They sit to the right of the steering column. The bunk heater and air conditioning (AC) controls are in the sleeper control panel.



WARNING

DO NOT drive with visibility reduced by fog, condensation, or frost on the windshield. Your view may be obscured, which may result in property damage, personal injury, or death. For clear visibility and safe driving it is extremely important for you to follow the instructions pertaining to the function and use of the ventilation/heating and defogging/defrosting system. If in doubt, consult your dealer. Maximum heating output and fast defrosting can be obtained only after the vehicle has reached operating temperature..



WARNING

Exhaust fumes from the engine contain carbon monoxide, a colorless and odorless gas. DO NOT breathe the engine exhaust gas. A poorly maintained, damaged, or corroded exhaust system can allow carbon monoxide to enter the cab. Entry of carbon monoxide into the cab is also possible from other vehicles nearby. Failure to properly main-

tain your vehicle could cause carbon monoxide to enter the cab, resulting in personal injury or death.



WARNING

Never idle your vehicle for prolonged periods of time if you sense that exhaust fumes are entering the cab. Investigate the cause of the fumes and correct it as soon as possible. If the vehicle must be driven under these conditions, drive only with the windows open. Failure to repair the source of the exhaust fumes may result in death, personal injury, equipment or property damage.



NOTE

DO NOT stay in the vehicle with the engine running or idling for more than 10 minutes with the vehicle's Heater and A/C ventilation system in RECIRC or at LOW FAN SPEED. Even with the ventilation system on, running the engine while parked or stopped for prolonged periods of time is not recommended.



NOTE

Keep the engine exhaust system and the vehicle's cab ventilation system

properly maintained. It is recommended that the vehicle's exhaust system and cab be inspected (1) By a competent technician every 15,000 miles (24,140 km); (2) Whenever a change is noticed in the sound of the exhaust system; or (3) Whenever the exhaust system, underbody, or cab is damaged.



NOTE

If you are required to idle your vehicle for long periods of time, install an auxiliary heater or automatic idle control. These auxiliary devices can reduce fuel consumption and save you money.



NOTE

If you are parked next to idling vehicles, move your vehicle or do not stay in your vehicle for prolonged periods of time.

Air Conditioner Controls

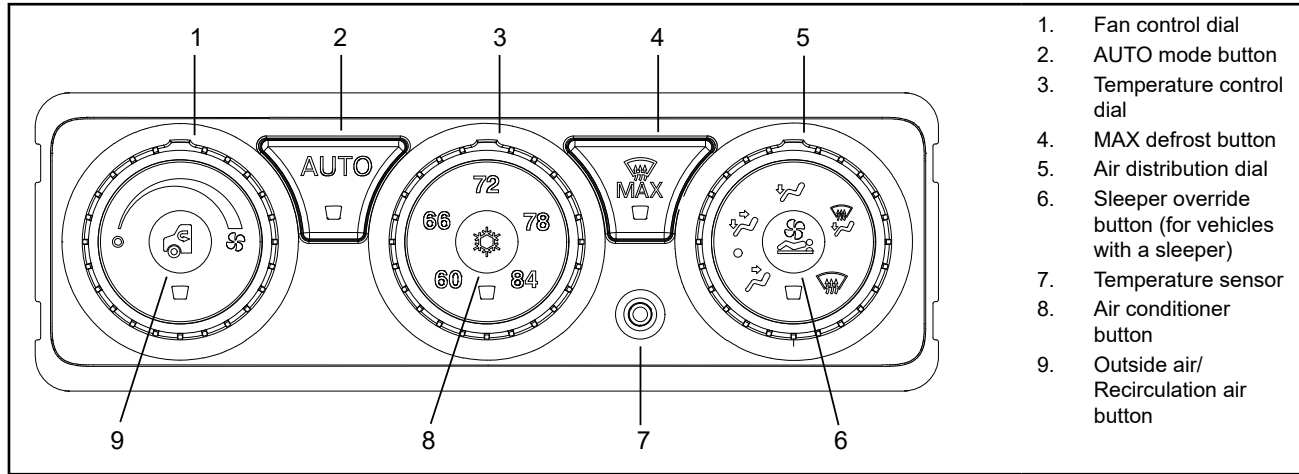

1. Fan control dial
2. AUTO mode button
3. Temperature control dial
4. MAX defrost button
5. Air distribution dial
6. Sleeper override button (for vehicles with a sleeper)
7. Temperature sensor
8. Air conditioner button
9. Outside air/ Recirculation air button

Air Conditioning (AC) Functions

Symbols for the AC Control Panel

Image	Function
	You can choose inside (cabin) or outside air for

Image	Function
	AC. To change the air source selection, use the button inside the fan speed control dial. Recirculated (cabin) air selects automatically in defrost modes.

Image	Function
	The fan speed is adjusted by rotating the dial clockwise to increase speed or counterclockwise to decrease speed.
AUTO	Automatic air conditioner function









Image	Function
	The button inside the temperature control dial engages the AC compressor. When activated the indicator on the button illuminates. During AUTO mode, the AC button indicator remains illuminated constantly, even when the compressor cycles.
	Maximum defrost function
	Toggle the power to the sleeper HVAC unit using the button inside the air distribution dial. When activated, the indicator on the button illuminates. The sleeper HVAC unit functions to the settings of the sleeper control.
	Floor Vents

Image	Function
	Defrost vents (and fresh air intake)
	Panel and Floor Vents
	Panel Vents
	Floor and defrost vents (and fresh air intake)

How to Manually Control the Cab Air Conditioner

- Temperature Control Set Point** Set the cab temperature using the temperature control dial. The operating range is 60°F (16°C) and 84°F (28°C). Adjustments are made in two degree Fahrenheit increments.
- Air Conditioner** The button inside the temperature control dial engages the AC compressor. When activated the indicator on the button illuminates. During AUTO mode, the AC button indicator remains illuminated constantly, even while the compressor cycles.



NOTE

Fan Control Dial must also be in the ON position for A/C to be on. A/C engages automatically in AUTO, defrost, and floor/defrost.

The air conditioner defaults to manual mode when switched on. Select the fan speed, air temperature, and air outlets using the dials on the controller.

1. To adjust the fan speed, turn the **Fan control** dial clockwise to increase speed or counterclockwise to decrease speed.
2. To adjust the temperature setting, turn the **Temperature control** dial to the desired temperature. The system automatically adjusts the outlet air temperature to achieve the desired cab temperature.
3. Push the **Air Conditioner** button if the air temperature must be colder, this button switches on the compressor.



4. To adjust the air distribution, turn the **Air Distribution** dial to distribute cab air as indicated by the dial graphics.
5. Press the **Recirculation** button to use cab air instead of outside air.



The temperature of the air from the vents fluctuates as the vehicle works to achieve the chosen cab temperature.

When idling for short periods of time, switch the fan ON. Then turn OFF **recirculation**. For vehicles with a sleeper, use the cab control to activate or deactivate the sleeper HVAC. Use the button inside the mode dial.

Auto Mode for the Air Conditioner

The AUTO mode manipulates several variables. These include air distribution, air temperature, fan speed, AC compressor, and cab air recirculation. The Auto mode adjusts to achieve the comfort level selected on the temperature dial.

Depending on the specific environmental conditions, the air temperature can be slightly higher or lower than the set point. This variation is a normal function of the AUTO mode and is not a malfunction. The

button that enables automatic mode is labeled **AUTO**.

Adjust the temperature knob, and the system responds to obtain the selected comfort level as quickly as possible.



Set the cab temperature using the temperature control dial. The operating range is 60°F (16°C) and 84°F (28°C). Adjustments are made in two-degree increments.

The AUTO function uses a sunlight sensor to measure the amount of sunlight entering the cab. You can find this sensor at the base of the windshield on the driver's side. Do not block this sensor.

The system remains in automatic mode until the driver adjusts both the fan speed and air distribution dials on the control.

Semi-Automatic Mode

During AUTO mode, the operator can override any settings and operate in a semi-automatic mode. You can override AUTO mode using the dials and/or buttons

on the HVAC control. In semi-automatic mode, the AUTO button indicator extinguishes. Instead, the indicator of the adjusted setting illuminates. For example, if the driver adjusts the fan dial while in AUTO mode, the fan dial indicator illuminates. The fan speed also adjusts to the setting of the dial. However, the temperature and air outlet settings continue to function automatically. Also, if the user adjusts the air distribution setting while in AUTO mode, the air distribution dial indicator illuminates. Then the distribution adjusts to the setting of the dial. The fan and temperature settings continue to function automatically.

Economy Function

An economy function is also available in semi-automatic mode. In this mode, the system operates in AUTO mode without the use of the AC compressor. The operator can select economy by initiating AUTO mode and then pressing the AC button to disengage the compressor. The indicators for AC compressor and AUTO mode do not illuminate while operating in economy mode.

How To Operate an Automatic Cab Air Conditioner

Follow these steps to activate the Auto Mode:

1. Press the **AUTO** button.
2. Rotate the **Temperature Control** dial to the desired temperature.

The system achieves the comfort level associated with the temperature selected. Cab temperature can be slightly higher or lower than the selected temperature. This variation is normal when in **AUTO** mode. This fluctuation is not a system malfunction.

MAX Defrost Mode

The heating and air conditioning (AC) system provides for one-touch windshield defrosting. Certain driving conditions cause fog or ice to form on the windshield. By pressing the **MAX** defroster button, the system automatically adjusts certain settings to maximize clearing of the windshield. These settings include the blower speed, recirculation, air temperature, and air outlet distribution. The system remains in this mode until the driver presses the button again or adjusts the dials.



The air temperature in MAX defrosts mode adjusts to the warmest temperature setting. This setting helps to clear the windshield of ice and fog more quickly. Outside air mode and the air conditioner compressor are also active to maximize performance. The AC compressor and recirculation switches do not function in MAX Defrost, and the lights on those switches blink when pressed.

Bunk Heater and Air Conditioner Controls (Option)

Unlike the cabin air temperature controls, the sleeper temperature control alters the air temperature based on the knob setting.

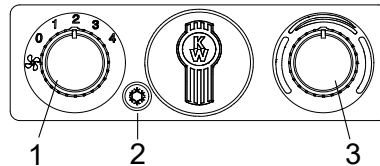

1. Air speed
2. Compressor
3. Temperature adjustment

The temperature control does not align to specific temperatures. Turning counterclockwise means cooler than it is now. Clockwise means warmer than it is now. Once reached, the desired temperature holds automatically. A separate switch on the dash HVAC unit sends power to the "bunk" or sleeper control unit. Switch the button on the cab HVAC panel to the ON position to use the sleeper controls.

You can toggle power to the sleeper HVAC unit using the button inside the air distribution dial. When activated, the indicator on the button illuminates. The sleeper HVAC unit functions to the settings of the sleeper control.

**NOTE**

On the Cab Control Unit, the sleeper enable switch must be pressed to turn ON power to the sleeper control unit. In addition, if air conditioning is requested in the sleeper, the air conditioner switch on the cab control unit will be turned ON and fan in the cab heater and air conditioning unit will be turned on low (if it was OFF) automatically.

**NOTE**

The sensor is located on the sleeper HVAC control panel and measures the sleeper air temperature at the panel. There will be a time delay between temperature control adjustment and sleeper air temperature change. Also, be careful of any heat source which could affect the air temperature by the sensor. Avoid hanging items (shirt, jacket, hat, etc.) which could block the airflow to the sensor.

Air Conditioner Operating Tips**CAUTION**

During extreme cold weather, DO NOT blow hot defroster air onto cold windshields. This could crack the glass. Turn the Air Flow Control Dial to Defrost and adjust the fan speed accordingly while the engine warms. If the engine is already warm, move the Temperature Control Dial to "cool," then gradually increase the temperature when you see that the windshield is starting to warm up. Failure to comply may result in equipment damage.

Defrosting and Defogging the Windshield

You can clear the cab windshield and side windows of ice and fog in two ways. The first is to use the **MAX** defrost mode. You can also manually adjust the air distribution dial to the defroster position. The manual defrost-defogging mode differs from the **MAX** defrost mode by allowing the driver to select an air temperature other than full heat. This mode allows the driver to maintain a constant cab temperature

while defrosting the windshield. However, reduced performance can follow.

- Adjust the fan speed too high by rotating the fan control dial clockwise.
- Set the air distribution dial to the defroster mode setting. This mode automatically engages the outside air and the air conditioner compressor.
- Adjust the temperature dial to add heat as needed.

For maximum performance, adjust the temperature to maximum heat by rotating the temperature dial clockwise. The driver can also use the Floor or defrost setting on the air control.

For Maximum Cooling

- Adjust the fan speed to its highest setting by rotating the fan control dial clockwise.
- Set the air distribution dial to the panel setting.
- Adjust the air temperature to maximum cooling by rotating the temperature dial counterclockwise.
- Engage the air conditioner compressor by pressing the air conditioner button.

- Set the air source to recirculation mode by pressing the outside air-recirculation air button. The button indicator light illuminates.

For Maximum Heating

- Adjust the fan speed to its highest setting by rotating the fan control dial clockwise.
- Set the air distribution dial to the Floor setting.
- Adjust the air temperature to maximum heat by rotating the temperature dial clockwise.



NOTE

The engine must be at operating temperature for maximum heating. If operating in AUTO mode, heating airflow is not allowed until the engine warms sufficiently to provide required coolant temperatures.

Air Dehumidification

You can also use the air conditioner system to reduce the humidity level of the cab and clear fog from the windshield.

- Adjust the fan speed to the desired airflow setting.
- Engage the air conditioner compressor by pressing the air conditioner button.
- Set the air source to outside air mode by pressing the outside air and recirculation air button. The button indicator light must NOT be illuminated.



NOTE

That the A/C compressor may not engage when the outside temperature is below 34°F (1°C).

Cab Air Distribution

Equal distribution of air is important in maintaining a constant cab interior temperature. For best performance, all vents must remain open to allow AUTO mode to function properly. To maintain the selected cab temperature, AUTO mode can provide an air temperature from the vents that differs from the temperature set point. The driver can redirect the air instead of adjusting the temperature set point or closing the vent. The system can have difficulties in obtaining the desired

cabin temperature when the temperature setting rapidly changes.

You set the mode of air distribution inside the cab using the air distribution dial. Five icons on the dial indicate the primary mode options. The driver can also select a secondary mode in between the primary modes indicated by points on the dial. The side windows receive airflow in all modes.

Outside Air or Recirculation Air

Selecting air recirculation mode completely isolates the cab interior from the outside air. This mode is helpful in preventing dust, pollen, and odors from entering the cab. Additionally, recirculation mode can reduce the amount of time required to cool down the vehicle while in maximum cool down. This mode can increase fogging on the windshield. A coarse air filter provides for recirculation air. This filter is under the instrument panel. The outside air mode provides for 100% outside air into the cab. This mode is helpful with windshield defogging. A pleated air filter located under the hood provides filtration for dust, pollen, and debris. If equipped, the vehicle can also provide for ember filtration or fine particulate filtration.

Sleeper Alarm Clock

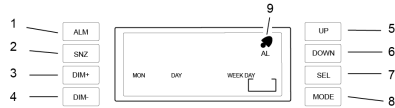

1. Alarm - press to switch on the alarm
2. Snooze - press to snooze the alarm bell
3. Dimmer or brighter - press to make the display brighter
4. Dimmer - press to make the display less bright
5. Increase the value of setting
6. Decrease value of setting
7. Select - press to choose a setting while adjusting either the time or the alarm
8. Time and Alarm value setting - press to change the time-date and or alarm setting
9. Active alarm icon

Turning the Alarm On/Off

Press the **ALM** button to switch the alarm on and off. The icon (9) illuminates when the alarm is active. When the time reaches

the set time, the alarm rings. Without pressing the **SNZ** button, the alarm continues ringing for 15 minutes before stopping. Pressing any other button except **SNZ** (2) switches off the alarm.

Snooze Operation

When the alarm rings press the **SNZ** button (2) to silence the alarm for 9 minutes. While the alarm is on, the small bell icon (9) flashes. You can use the **SNZ** button as many times as desired.

Dim Control Operation

Press the DIM+ or DIM- buttons (3, 4) to change the brightness of the display.

Set the Sleeper Alarm Clock Time

1. Press the **MODE** button until the screen begins flashing.
2. Use the **UP** and **DOWN** buttons to adjust the value.
3. Press the **SEL** button to adjust the next setting and use the **up** and **DOWN** buttons to change the value.
4. Repeat this process for all settings. The alarm clock scrolls in the following order each time you press the **SEL** button:

- Year
- Month
- Day
- Hours
- Minutes

5. Press the **MODE** button once you set the minutes. This exits and saves the settings.

Set the Sleeper Clock Alarm

1. Press the **MODE** button twice until the screen displays the AL icon.
2. Use the **UP** and **DOWN** buttons to adjust the setting.
3. Press the **SEL** button to adjust the next setting and use the **UP** and **DOWN** buttons to change the setting.
4. Repeat this for all areas. The alarm clock will scroll in the following order each time you press the **SEL** button.
 - Hours
 - Minutes
5. To exit and save your settings, press the **MODE** button once you have set the minutes.

Cab Accessories

Radio (Option)

The vehicle has one of two stereo systems. An AM/FM stereo receiver is standard equipment and can have a combination of CD, satellite radio, USB media, or Bluetooth. A stereo system integrated with GPS navigation and telematics is also available (option). For instructions on how to operate the particular radio, see the supplemental operating manual for those units.

The controls for the infotainment system are on the Right Switch Pod of the steering wheel.

Right Switch Pod (Infotainment)

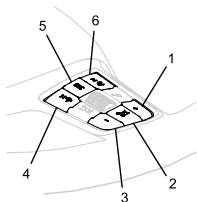

1. Volume increase
2. Mute

3. Volume decrease
4. Previous or cancel
5. Media source
6. Next track

Cigarette Lighter and Ashtray (Option)



The 12V accessory power port will operate with the ignition key in either the OFF, ACC (accessory), or ON position.

This vehicle comes standard with two cupholders and power ports located in the center of the dashboard. This vehicle can have the optional ashtray insert (for the cupholder) and the optional cigarette lighter instead of a power port. To operate, push in on the knob end of the lighter. After a few moments, the lighter will automatically pop out, glowing hot and ready to use. After use, insert the lighter back into the socket without pushing all the way inches (in). The socket of the cigarette lighter can power 12 V, 15 A appliances. Examples are: a hand spotlight or a small vacuum cleaner.



WARNING

Do not attempt to operate a cigarette lighter using the 12V power port receptacle. A cigarette lighter inserted into the 12V power port will heat up and be expelled into the cab, potentially causing fire. Failure to comply may result in death, personal injury, equipment damage, or property damage.



WARNING

DO NOT place paper or other combustible substances in an ashtray, it could cause a fire. Keep all burnable materials, besides smoking materials, out of the ashtray. Failure to comply may result in death, personal injury, equipment or property damage.

**WARNING**

DO NOT exceed the voltage/ampere capacity of the accessory power port. It could result in a fire. Follow all warnings and instructions in the operator's manual for the appliance you are using. Failure to comply may result in death, personal injury, equipment or property damage.

Glove Box

The truck has a glove box to store important documents, the vehicle literature set (including this Operator's Manual), and other related materials. You can choose from various other interior storage options to store personal supplies or small tools:

- center console
- map pocket on the door
- Overhead storage compartments

**WARNING**

DO NOT drive with the glove box open, it can be dangerous. In an accident or sudden stop, you or a passenger could be thrown against the cover

and be injured. To reduce the risk of personal injury during an accident or sudden stop, keep the glove box closed when the vehicle is in motion.

**WARNING**

DO NOT carry loose objects in your cab, it can be dangerous. In a sudden stop, or even going over a bump in the road, they could fly through the air and strike you or a passenger. You could be injured or even killed. Secure all loose objects in the cab before moving the vehicle. Carry any heavy objects such as luggage in the exterior storage compartment and close it securely.

Appliances

If the vehicle has a television or other appliance, make sure that they are compatible with the vehicle's electrical system. Secure them in the cab so they cannot come loose in a sudden stop.

**WARNING**

In a sudden stop or collision a heavy object in your cab could strike you or anyone with you. You could be injured or even killed. Secure any appliance (such as a radio, or TV) you add to your cab. Failure to comply may result in death, personal injury, equipment damage, or property damage.

Vehicle Telematic System

The vehicle can be equipped with an onboard telematics system. This system is a Global Positioning Satellite (GPS)-linked computer. It receives input from multiple sources to locate the vehicle. Read and understand the Supplemental Telematics and Navigation System Owner's Manual. Observe the warnings, cautions, and notes that follow before using the system.



WARNING

Verify legal weight and height restrictions for the route suggested by the telematic system. Failure to verify height restrictions could lead to an impact causing death, personal injury, or property damage. Failure to verify weight restrictions could result in a traffic infraction.



WARNING

Only glance at the system monitor while driving. Prolonged periods of viewing while driving could result in an accident involving death or personal injury.



WARNING

DO NOT program the telematic system while driving. Always stop your vehicle when programming or changing the settings on the telematic system. Programming the system while driving can cause you to take your eyes off

the road, which could result in an accident involving death, personal injury or equipment damage.



WARNING

Regardless of how and where the navigation system directs you, it is your responsibility to operate the vehicle in a safe and legal manner. Failure to comply may result in death, personal injury, equipment or property damage.



WARNING

Ensure the volume level of all audio devices is set to a level that still allows you to hear outside traffic and emergency vehicles. Failure to comply may result in death, personal injury, equipment or property damage.



NOTE

DO NOT rely on the telematic system to route you to the closest emergency

services. Not all emergency services are in the database.



NOTE

The map database is the most current available at the time of production. The database is designed to provide you with route suggestions and does not take into account the relative safety of a suggested route or of factors that may affect the time required to reach your destination. See the Supplemental Navigation System Owner's Manual for more information.

Using the Telematic System

Screen Display On/Off

1. Press and hold the **Power (Light)** button for approximately 1 second.
2. Switching on the screen displays the following warning and informational screen:

Warning and Informational Screen

<p>WARNING</p>  <p>DO NOT let this device distract you while driving. Always concentrate on driving. Distractions could cause an accident resulting in injuries to you or others.</p>
<p>IMPORTANT</p>
<p>Disclaimer: Map data can be inaccurate and navigation routes cannot be available for larger-size vehicles. It is the responsibility to operate the vehicle in a safe and legal manner. This obligation is regardless of how and where the Navigation System directs you. Note: Before using this system, read the Owner's manual to learn how the navigation system operates. Some functions of this</p>

<p>WARNING</p>  <p>DO NOT let this device distract you while driving. Always concentrate on driving. Distractions could cause an accident resulting in injuries to you or others.</p>
<p>system cannot operate when the truck is in motion.</p>

Disclaimer: The vehicle manufacturer is not responsible for erroneous map data, incorrect routing or any downtime. This responsibility includes all other damages associated with, or arising from the use of the Navigation System.

Passenger Side 'Down' Mirror

 <p>NOTE</p>
<p>The vehicle can come with a digital side-view mirror option. Refer to the PACCAR Digital Vision System with Mirrors operator's manual for instructions. This manual is in the glove box.</p>

Warning and Informational Screen: DO NOT let this device distract you while driving. Always concentrate on driving. Distractions could cause an accident resulting in injuries to you or others.

3. After reading the information, touch the **T** in the upper right corner of the screen with the finger indicating you acknowledge and understand the information. The menu screen appears next.
4. To switch off the system, press and hold the **Power (Light)** button for 3 seconds.

3

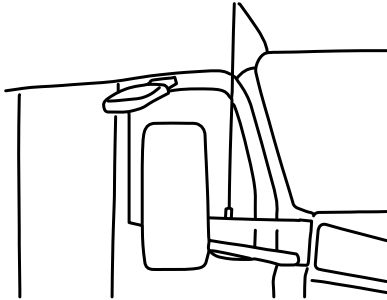

desired view. Tighten the screws when the position is correct.

A mirror is located above the passenger door that provides a quick view of the blind spot created by the passenger door.

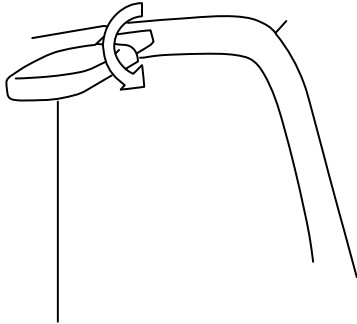

Loosen the screws on the top of the mirror to rotate the mirror up or down to get the

Chapter 4 | DRIVING

Starting and Operating.....	155
Engine Operations.....	161
Lighting.....	184
Transmission.....	186
Brakes.....	193
Axle and Suspension.....	204
Trailer Operations.....	210
Driving Tips and Techniques.....	214
What to Consider when using a Sleeper Bunk.....	217
Stopping the Vehicle.....	218

Starting and Operating

Since each vehicle is custom-equipped, all engine operation instructions in this manual are general. You will want to consult the manual for your engine to find out details about your specific engine's needs. You may need to use a slightly different procedure from the one outlined here.

Anti-theft

With Anti-theft active, you must enter the correct passcode to start the engine.



NOTE

Enabling Anti-theft requires drivers that share this vehicle to enter a passcode before starting the engine. This action is done by entering the Settings sub-menu. It is also possible to disable Anti-theft or alter the Favorites View there.

After entering the passcode, you have five minutes to start the engine. After five minutes of engine off, you must re-enter the passcode. You can postpone this

safety measure in one minute intervals by using any steering wheel switch. Upon re-enabling the Anti-theft feature, the previous passcode is still the passcode. Anti-theft allows for only one passcode per vehicle.

Systems Check Summary

Systems Check

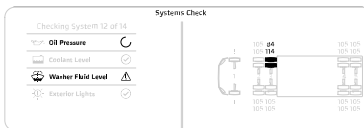

After completion of a system check, you can view the results in a summary. You can view a detailed explanation of this summary by accessing the Menu after the Systems Check.

How To Start Vehicle in Normal Weather



CAUTION

Never operate the starter motor with the engine running. The starter and fly-wheel gears could clash or jam, se-

verely damaging them. Failure to comply may result in equipment damage or property damage.



NOTE

Some starters are equipped with over-crank protection. Check the Engine Operation and Maintenance Manual for details.

When the outside temperature is above 50°F (10°C), use the following procedure: With anti-theft enabled, the first time you turn the ignition switch to START, you must enter the passcode.

1. Set the parking brake.
2. Put the main transmission in neutral.
3. Disengage (depress) the clutch (with manual transmission).
4. Turn the ignition switch to START.



NOTE

With anti-theft enabled, you must enter the passcode to start the engine (see [Anti-Theft](#) on page 74).

5. If the engine does not start within 30 seconds, release the ignition switch. To avoid overtaxing the starter motor or the batteries, do not use the starter for more than 30 seconds. Let the starter motor cool and the batteries recover for two minutes before trying again. While waiting, check the fuel lines for possible fuel starvation or air leaks. Starting failure can mean that there is no fuel reaching the injectors.
6. When the engine starts, begin to watch the oil pressure gauge. Check the engine manufacturer's manual for the right pressure for the engine. If the oil pressure does not rise within a few seconds, stop the engine. Find out what is wrong before restarting the engine.
7. Slowly engage (release) the clutch after the engine starts.
8. Wait for the oil pressure to reach normal operating pressure before

driving the vehicle. Also do not idle faster than 1,000 rpm.

Tips To Remember When Starting a Vehicle in Cold Weather

By following a few simple guidelines, you can extend the service life of the engine:

- Keep the electrical system in top condition.
- Use the best quality fuel of the recommended grade.
- Use the recommended engine lubricating oil.
- For manual transmissions and auxiliary (AUX) transmissions, leave the transmission in neutral. This action allows the transmission lubricating oil to warm up (approximately 3-5 min) before operating the vehicle.

Engine Block Heater (Option)

PACCAR has many variants of block heater harnesses. If needed, work with the dealer if you require assistance identifying the block heater equipment. The on-vehicle connection port configuration also helps identify voltage, current, and usage requirements.

To preheat the engine before starting, plug the engine block heater into a properly grounded AC electrical source. **DO NOT** start the engine with the heater plugged inches (in)



WARNING

If not properly maintained and operated, engine block heaters can cause fires. Regularly inspect the engine block heater wiring and connector for damaged or frayed wires. **DO NOT** use the heater if there are any signs of problems. Contact the authorized dealer or the manufacturer of the heater if you are in need of repairs or information.



CAUTION

Always unplug heater before starting the engine. Damage to the cooling system could occur if the heater is not turned OFF (unplugged).



WARNING

Ensure all components of the shore connection (cord, outlet, power source, timer, hookup panel, fuses, etc.) meet or exceed the load requirements of the engine block heater (element and harness). Failure to comply may result in equipment damage, bodily injury, or death.

Longer runs require heavier gauge cords. It is recommended to use a 10-AWG cord for up to 100 ft. Connect the cord to the block heater first, then plug the cord into the supply outlet. If a longer cord is needed, consult your local electrical codes, and use the recommended AWG cord for a 20-amp load. PACCAR uses both 110 and 220 volt engine block heaters. Make sure to reference the correct voltage if you need a longer cord.



Safe practice tips:

- Know your truck's requirements

- Ensure all components of shore power connection meet requirements
- Use a thermostat or timer to limit overuse
- Allow sufficient time for warmup
- Safely route cord and position as a reminder to disconnect if possible
- Always disconnect the block heater from shore power before starting the engine

Consider the length of cord required to connect the block heater to shore power.

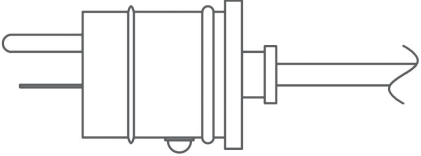
Configuration	Voltage	Amperage	Wattage
	120	15	0–1700
	120	20	1701–2400

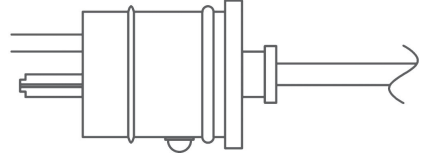
Configuration		Voltage	Amperage	Wattage
		240	15	0-3300
		240	20	3301-4800

Engine, Under Hood Air Intake

This switch opens a door in the engine air filter housing. This action allows intake of air from under the hood instead of outside air. This switch can be useful when starting the vehicle in cold-weather conditions.



CAUTION

Only operate the under hood intake air switch when outside temperatures are below 32°F (0°C). Engaging the under hood air intake while temperatures are above freezing may result in engine damage.

Engine Warm Up

Engine warm-up allows oil film to establish between pistons and liners, shafts, and bearings. It creates this film while the engine gradually reaches operating temperature.

1. After starting the engine, idle it at approximately 600 rpm while checking the following:
 - Oil pressure
 - Air pressure
 - Alternator output

2. After a few minutes of idling at 600 rpm, increase the idle speed to 900 rpm or 1,000 rpm. Continue the warm-up. This procedure allows the oil to warm and flow freely. This permits pistons, liners, shafts, and bearings to expand slowly and evenly. In cold temperatures, it could help to increase idle speed.

**NOTE**

In colder climates where the temperature is often below freezing, the warm-up for turbocharged engines is especially important. Chilled external oil lines leading to the turbocharger will slow the oil flow until the oil warms, reducing oil available for the bearings. Watch the engine oil temperature or pressure gauge for a warming trend before increasing engine idle speed (rpm).

3. Continue the engine warm-up until the coolant temperature reaches at least 130°F (54°C). At this temperature, you can use partial throttle. Wait until the coolant temperature is at least 160°F

(71°C) before operating at full throttle.

**NOTE**

Under most circumstances, idling the engine for long periods merely wastes fuel. In severe arctic weather conditions, however, you may need longer idling to make sure that all parts of the engine are fully lubricated.

**WARNING**

Exhaust fumes from the engine contain carbon monoxide, a colorless and odorless gas. DO NOT breathe the engine exhaust gas. A poorly maintained, damaged, or corroded exhaust system can allow carbon monoxide to enter the cab. Entry of carbon monoxide into the cab is also possible from other vehicles nearby. Failure to properly maintain your vehicle could cause carbon monoxide to enter the cab, resulting in personal injury or death.

**WARNING**

Never idle your vehicle for prolonged periods of time if you sense that exhaust fumes are entering the cab. Investigate the cause of the fumes and correct it as soon as possible. If the vehicle must be driven under these conditions, drive only with the windows open. Failure to repair the source of the exhaust fumes may result in death, personal injury, equipment or property damage.



WARNING

To reduce the chance of personal injury, vehicle damage and/or death from overheated engines, which can result in a fire, never leave the engine idling without an alert driver present. If the engine should overheat, as indicated by the engine coolant temperature light, immediate action is required to correct the condition. Continued unattended operation of the engine, even for a short time, may result in serious engine damage or a fire. Failure to comply may result in death, personal injury, equipment or property damage.



CAUTION

The use of a winterfront can result in excessive coolant, engine oil, and intake air temperatures, which may lead to overheating and possible engine damage.



CAUTION

DO NOT allow your engine to idle, at low rpm (400-600 rpm), longer than five minutes. Long periods of idling after the engine has reached operating temperatures can decrease engine temperature and cause gummed piston rings, clogged injectors, and possible engine damage from lack of lubrication. The normal torsional vibrations generated can also cause transmission wear.



NOTE

Keep the engine exhaust system and the vehicle's cab ventilation system properly maintained. It is recommended that the vehicle's exhaust system and cab be inspected (1) By a competent technician every 15,000 miles (24,140 km); (2) Whenever a change is noticed in the sound of the exhaust system; or (3) Whenever the exhaust system, underbody, or cab is damaged.



NOTE

If you are parked next to idling vehicles, move your vehicle or do not stay in your vehicle for prolonged periods of time.

How to Warm up the Transmission

In cold weather (below 32°F (0°C)), shifting can be sluggish upon initial start-up. Transmission warm-up is especially important under these conditions, but it is always a good idea to warm up the transmission before starting out on the road.

To warm up the transmission lubricating oil during engine warm up, with a single transmission (manual and automatic):

1. Put the transmission in neutral.
2. Release the clutch pedal (manual only). Operate the transmission in neutral for 3 to 5 minutes before moving the vehicle.
3. If you have a two-transmission combination:
 - a. Put the main transmission in gear.

- b. Put the auxiliary (AUX) transmission in neutral. This action allows the transmission countershaft to turn, agitating the oil and warming it.

Engine Operations

Indicators Around the Speedometer

Indicators Around the Speedometer

1. Engine Brake
2. Transmission Gear Indicator
3. Speed Limit Recognition (Option)
4. Cruise Control, Adaptive Cruise (Option), Predictive Cruise (Option)
5. Power Take Off (PTO)

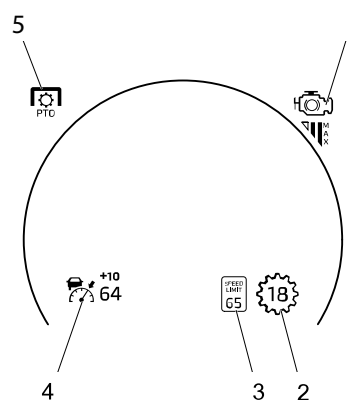

Speed Limit



Certain PACCAR vehicles can recognize traffic signs for speed limits (both US and Canada). The indicator can change color when the vehicle travels faster than a posted speed limit. Where metric signs apply, the display cannot change to KPH until scanning at least 3 metric traffic signs.

Engine Brake Operation

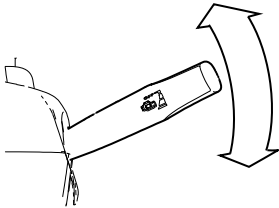

Moving the lever clockwise will engage the engine brake. Increase the amount of engine brake by moving the lever further clockwise. Each position has a corresponding level of engine brake.

Position	Amount of Engine Brake
Off	0%
1	33%
2	66%

Position	Amount of Engine Brake
3	100%

Engine Brake Operation for a Vehicle With Automated Transmission

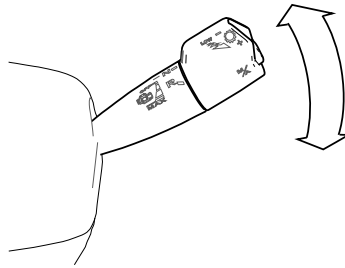

Moving the shifter down (clockwise) engages the engine brake, with each downward position providing more engine braking. The bottom-most position

(Position 4) is a momentary position and activates MAX mode.

Position	Amount of engine brake
Off	0 %
1	33%
2	66%
3	100%
4*	100% AND engages MAX mode.

The corresponding engine brake level (and MAX mode) indicates on the engine brake indicator.

MAX Mode Operation

Some vehicles have a MAX mode. Use this feature when a situation requires 100% engine brake and the additional resistance from using the transmission lower gears.

1. Move the transmission shifter to the 3rd position, enabling 100% engine braking.

* This position is momentary and reverts back to position 3 upon releasing the shifter.

- Pull the transmission shifter down again. Then allow the shifter to move back up to the previous position (3rd position).

Engine Brake + MAX

The vehicle remains in Max mode until the transmission downshifts into the coast-down gear, or the operator:

- Presses the accelerator pedal.
- Upshifts.
- Reduces the engine brake level.
- Attempts to activate MAX mode again (pulling the column shifter down to the temporary 4th position).
- Selects Neutral (N).
- Selects Low mode.

How To Deactivate MAX Mode

Vehicles with PACCAR TX-12/TX-18 or Eaton Endurant automated transmissions have the engine brake function integrated with the transmission controls. Follow

these steps to deactivate **MAX** engine brake mode.

1. Accelerate with the throttle pedal.
2. Upshift, see [Up or Down Shifting](#) on page 191.
3. Wait for the transmission coast down gear to engage.
4. Reduce the engine brake level.
5. Re-initiate **MAX** mode.
6. Select Neutral **N**. See [Drive Neutral Reverse Selector](#) on page 191.
7. Select **LOW** mode.

Engine Brake Indicator

This indicator appears when the engine braking (compression brake or exhaust brake) is active. It shows available engine braking levels near the indicator, with the selected braking level highlighted:



When using engine braking, the engine brake indicator turns green. An override of active engine braking can occur when the operator (or a vehicle feature, such as Adaptive Cruise Control (ACC)) provides acceleration. In these cases, the engine brake indicator turns white (enabled but not active) while the vehicle accelerates.

How To Change Fast Idle Control (FIC) Speed

The truck must be stationary, the transmission in neutral, and the park brake set.

**CAUTION**

Do not let the engine rpm operate beyond the maximum governing rpm. Operating the engine above the maximum governing rpm can result in engine damage.

1. Press the Cruise Control **ON-OFF** toggle. If enabled, the white FIC indicator appears near the Speedometer/ Tachometer.
2. To set the FIC speed:



- Press **RES -** to resume the last used FIC speed.
- Alternatively, use the accelerator to increase rpm. Then press **SET +**.
- You can also press and hold **SET +** to increase and set the new FIC speed.
- You can also press and hold **RES -** to reduce FIC speed. Then press **SET +**.

When active, the FIC indicator is green.

How To Start the Power Take Off (PTO)

You can activate PTO *mode* in several different ways. If you have the **MX engine** option, PTO Mode is typically activated by **engaging a PTO**. You can also activate it by using the Dash PTO Mode Control Switch. For the **Cummins engine**, PTO mode is typically activated by engaging a PTO. You can also activate it by setting the Cruise Control Switch to ON but while the *vehicle is stationary*. The following information below provides the basic process of enabling and activating PTO engine speed control: It also outlines what

the operator must observe during this process.

	NOTE
The PTO cannot engage instantly. There is a slight delay.	
	CAUTION
Increasing engine rpm before the PTO is active can prevent the PTO from engaging and/or cause PTO damage.	

1. Toggle the **PTO ON/OFF** switch, or the Dash PTO Mode Control Switch, to the ON position. Text indicating PTO engagement and/or PTO Mode control location appear inside the speedometer. It is possible to see the letters AN in the transmission gear indicator when the PTO is active. This symbol indicates that the vehicle has the PACCAR TX-12/TX-18 or Eaton Endurant automated transmission.
2. Press the Cruise Control (CC) **ON/OFF** switch to enable PTO Speed Control operations. A white

speed control-enabled icon appears.

3. Optional: The PTO can have PTO presets located on the dash. If so,
 - If the truck comes with dash-mounted PTO preset switches, toggle the desired **PTO Preset** switch.
 - You can also use the dash-mounted **PRESET Increment and Decrement** switch. Cycle through the PTO presets to select the desired preset. PTO Speed Control is now active. Vehicles with an MX engine display a green PTO indicator with a target PTO engine speed.
4. Optional: Without PTO preset switches, press the **SET +** and **RES -** buttons. These buttons are on the steering wheel to command a desired engine speed. PTO Speed Control is now active. Vehicles with an MX engine display a green PTO indicator with a target PTO engine speed.
5. To alter PTO engine speed, use a combination of short and long presses of the **SET+** and **RES-** buttons. These buttons are on the

steering wheel (the cruise control buttons while the vehicle moves). Vehicles powered with PACCAR MX engines display the PTO engine speed above the PTO indicator.

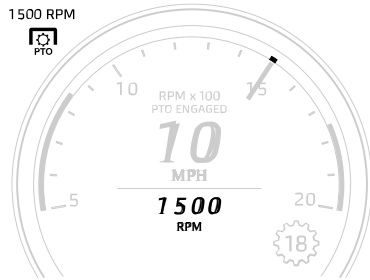

Driver Assistance

Driver Assistance (or Advanced Driver-Assistance Systems (ADAS)) defines various electronic features that assist the operator while driving. These features improve operator and vehicle safety by alerting the operator (and sometimes acting) to the driving environment. Driver Assistance features use electronic and hardware improvements to accomplish this task: cameras, radar, sensors, and in-cab notifications.

The features described in this section are a supplement to the ADAS OEM operator's manuals. These manuals are in the glove compartment of the vehicle. There can be various ADAS components optioned for the vehicle. Each option has its own manual. It is important that the operator becomes familiar with the OEM manuals for the ADAS equipment. They must read them before driving the vehicle.

ZF WABCO™ Advanced Driver-Assistance Systems (ADAS)

Product	Feature
ZF WABCO™ OnLane ALERT	Lane Departure Warning (LDW)
ZF WABCO™ OnGuard ACTIVE	Adaptive Cruise Control (ACC)
	Collision Mitigation

Bendix™ Advanced Driver-Assistance Systems (ADAS)

Product	Feature
Bendix™ Wingman Advanced	Adaptive Cruise Control (ACC)
	Collision Mitigation

Product	Feature
Bendix™ Fusion	Adaptive Cruise Control (ACC)
	Collision Mitigation
	Speed Limit Recognition
	Highway Departure Braking
	Lane Departure Warning (LDW)
	Advanced Emergency Braking
	Traffic sign recognition
	High Beam Assist

lightning conditions. The camera supports driver assistance systems (ADAS).

The camera is a component used for:

- Lane Keeping Assistant (LKA) system
- Lane Departure Warning (LDW) system
- Highway Departure Braking (HDB)
- Torque Assisted Steering (TAS)
- High Beam Assist (HBA)

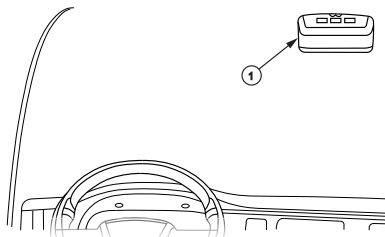

1. Camera



NOTE

The camera has overvoltage protection up to 42 V. It can withstand load dump surges up to at least 58 V for up to 400 ms without damage. The overvoltage protection concept includes a systematic shutdown of the camera, which leads to temporary loss of function.



NOTE

The system detects and stores errors during camera operation. Some errors trigger a restart of the system, others trigger a warning to the operator in case functionalities are temporarily not available.



NOTE

At extreme conditions, such as high outside temperatures, with deactivated air conditioning (AC), the camera may enter limited mode or shutdown.

Bendix Fusion Camera

The camera is forward-looking and has a sensor for integrated fusion. The camera has high resolution and high dynamic range. These specifications provide a high image quality even under non-ideal

**NOTE**

Avoid heating of the camera to temperatures above 105 °C to prevent hardware damage.

Bendix Fusion Radar

The radar sensor is mounted to the bumper at the front of the vehicle. The sensor detects road lane markers and other vehicles traveling in the same lane.

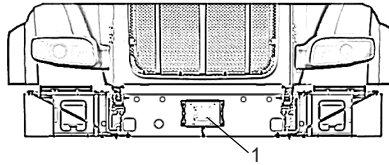

1. Bendix Fusion Radar

Bendix SafetyDirect Processor

The processor has capabilities for the online SafetyDirect platform by Bendix. These include a digital video recorder (DVR) that continuously records up to 145 hours of streaming video from Bendix's

forward-facing camera, a new high-definition color driver-facing camera, and an internal battery backup to help prevent data loss.

Cruise Control**WARNING**

DO NOT use a retarder (engine brake, exhaust brake, or transmission retarder) when operating on road surfaces with poor traction (such as wet, icy, or snow covered roads, or gravel). Retarders can cause the wheels to skid on a slippery surface. You could lose control of the vehicle or jackknife if the wheels begin to skid, resulting in an accident. Failure to comply may result in death, personal injury, equipment damage, or property damage.



WARNING

DO NOT use a retarder (engine brake, exhaust brake, or transmission retarder) in heavy traffic. Most retarders slow the truck without activating the brake lights, which would not alert a closely-following vehicle that the truck is slowing. This could result in a rear end collision resulting in death, personal injury, equipment damage, or property damage.

4

Cruise control functions and features may vary depending upon which engine you have. For a specific explanation of your cruise control, see the cruise control or engine manual included with your vehicle. This vehicle's electronic system will perform a 'rationality check' every time the vehicle is started. This check is to ensure that the service brakes are working before allowing cruise control to function. This safety feature is designed to ensure that a driver is able to cancel the cruise set speed by using the service brake pedal. The system will not allow cruise control operation if it does not pass the 'rationality check.' The display will prompt you to press the service brake pedal if it has not

been pressed since the vehicle has been started. In vehicles with PACCAR TX-12/ TX-18 or Eaton Endurant transmission, the cruise control switches may be located on the shift control knob. The left switch pod on the steering wheel contain buttons for the cruise control.

Left Switch Pod

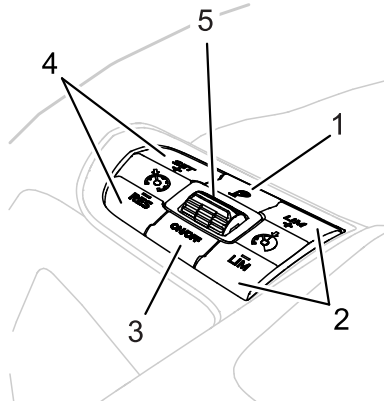

1. Trip
2. Variable Road Speed Limiter (VRSL) **LIM+** and **LIM-** (option)
3. Cruise Control **ON/OFF**

4. Cruise Control (CC) **SET+** and **RES-**
5. **Toggle**

The switches on the left side of horn pad manage vehicle speed functions like cruise control and variable road speed limiter (option). If the vehicle has adaptive cruise control (option), predictive cruise control (option), etc., the toggle switch is also used to operate that system.

Cruise Control Indicator



This indicator shows the operator which Cruise Control function is currently enabled or active. This includes:

- Cruise Control
- Adaptive Cruise Control (optional)
- Predictive Cruise Control (optional)



NOTE

PCC not offered on 1.9m models.

The indicator is white when the system is on and turns green when the cruise control set speed is active. For more information see [Cruise Control](#) on page 167.

How to Set Cruise Control Speed When Driving

The vehicle speed must be greater than 19 mph (30 kph) for PACCAR powered vehicles or 30 mph (49 kph) for Cummins powered vehicles and the engine speed must be over 1,100 rpm for the cruise set speed to work.

To Set the Cruise Speed:

1. Turn the cruise function on by using the ON/OFF button.
The cruise icon will appear in the display.



2. Accelerate the vehicle via accelerator pedal to the desired cruise speed.
3. Press the "SET +" button to set the cruise speed.



NOTE

Cruise Control may not hold the set speed going down hills. If the speed increases going down a hill, use the brakes to slow down. This will cancel Cruise Control.

The cruise set speed will appear in the display.

How to Change Cruise Set Speed

The vehicle cruise control must be ON and the cruise speed engaged.

1. To increase vehicle speed
 - Press or long press **SET +** until you reach the desired speed, or
 - Use the Accelerator Pedal to reach the desired speed, and then press the **Set +**
2. To decrease vehicle speed, press or long press **RES -** until you achieve the desired speed, and then press **SET +**.

The new cruise speed can be seen next to the Cruise Control Indicator.

Canceling and Resuming Cruise Control

There are four ways to cancel the set speed in cruise control:

1. Tap the brake pedal
2. Tap the clutch pedal
3. Turn the cruise control system OFF (ON/OFF button on steering wheel)
4. Press the Variable Road Speed Limit buttons

Using the brake or clutch pedal to cancel set speed allows the operator to use the RESUME feature. Pressing the **RES -** button will resume the vehicle speed previously set.

Pressing **ON/OFF** once will deactivate cruise control, and pressing it twice will turn off the system. When turning the system OFF, the previous set speed is removed from memory. The operator will have to manually reset the vehicle's cruise speed.

Variable Road Speed Limiter (option)

The Variable Road Speed Limiter (VRSL) prevents the vehicle from exceeding a chosen vehicle speed limit. This limit is selected by the operator and can be changed while driving. VRSL uses various braking methods to enforce the limit

including ignoring further input from the accelerator pedal, but will only use engine braking if available and enabled.

VRSL replaces the Cruise Control indicator when active and will show the VRSL limit to the right of the indicator. This limit is shown in gray but turns white when actively limiting vehicle speed. MX engines, additionally, show "LIMITED" on the speedometer.

When active, the VRSL speed limit can be changed using the **LIM+** and **LIM-** buttons in the right, steering wheel switch pod. See *How to Set the Variable Road Speed Limiter*. Enabling VRSL will disable Cruise Control.

VRSL can be canceled by

- A long press of the Cruise Control **ON/OFF**.
- Stopping then parking the vehicle.
- Activating the PTO (option) (MX engine only).

How to Set the Variable Road Speed Limiter

The Variable Road Speed Limiter (VRSL) cannot establish a limit while the parking brake is set or the PTO is in operation. The minimum VRSL setting is 25 mph (40 kph). Enabling VRSL will disable Cruise Control if Cruise Control is active.

1. Press the Cruise Control **ON/OFF** button in the left, steering wheel switch pod.



Indicates that the VRSL feature is awaiting input.

2. Press, or press and hold, **LIM+** or **LIM-** to incrementally, or continuously, raise or lower the VRSL limit.

The green VRSL indicator will replace the Cruise Control indicator, indicating that VRSL is enabled. VRSL (like Cruise Control) will use the current vehicle speed as the VRSL limit until changed.

Pressing either **LIM+** or **LIM-** will adjust the VRSL limit while this feature is active.

Adaptive Cruise Control (Option)



WARNING

The driver must remain alert, react appropriately, and use safe driving practices while using this driver assistance feature. Ultimate responsibility for safe operation of the vehicle remains with the driver at all times. Failure to comply may result in death, personal injury, equipment damage, or property damage.



WARNING

The driver must remain visually aware of the roadway and traffic and not rely solely on Drivers Assistance features to identify and respond to the variety of vehicles or objects sharing the road. The driver must read the ADAS operator's manual associated with this feature and understand its limitations prior to driving the vehicle. Failure to comply may result in death, personal injury, equipment damage, or property damage.

**WARNING**

Driver Assistance features respond differently to specific road, weather, and traffic conditions. The operator must read the ADAS operator's manual associated with this feature and understand how it responds to these specific conditions prior to driving the vehicle. Failure to comply may result in death, personal injury, equipment damage, or property damage.

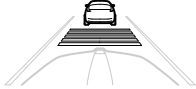

When Cruise Control is active, ACC accelerates and slows the vehicle to maintain a chosen distance from a detected forward vehicle. Collision Mitigation attempts to prevent a forward collision when the vehicle is advancing at speeds greater than 15 mph (24 kph). Please review the ACC section of this manual, and the manufacturer's manual, prior to driving this vehicle.

Adaptive Cruise Display

The display area for Active Cruise will contain dynamic visuals related to whether a tracked vehicle is in front and the amount of following distance set for Active Cruise. It will show an outline of a car in the display area when the radar is tracking a vehicle. Once it locks on to a tracked vehicle, it will display horizontal bars to represent the amount of following distance from the tracked vehicle. Once it locks and tracks a target vehicle, the system will adjust the speed to accommodate the speed of the tracked vehicle in front of it.

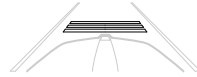
No Tracked Vehicle

The operator can set the amount of following distance from the tracked vehicle. There are five preset distances to choose from, represented by horizontal bars between the hood and the forward car. One bar represents the nearest following distance.

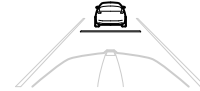
Following Distance One Bar

Five bars represents a farther distance.

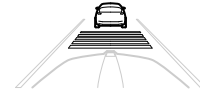
Following Distance Five Bars

See [Set ACC Following Distance](#) on page 171.

Set ACC Following Distance

Follow these steps to adjust the following distance for Adaptive Cruise Control:

1. Press the **Toggle** until the following distance bars illuminate in the view.

If the vehicle has Predictive Cruise Control, you may have to press multiple times to cycle through the other settings for PCC.

2. Rotate the **Toggle** up or down to choose the amount of following distance.
3. Push the **Toggle** again to set the following distance.

Following Distance Alerts

The display is white when a tracked vehicle is at a proper following distance. If the following distance decreases (less than 1.5 seconds), the following distance bars turns amber. When the following distance decrease more (0.5 seconds), the following distance bars turns red.⁹

Object Detected Alert

When Collision Mitigation instrumentation detects a roadway object not recognized as a vehicle, the following graphic will show in the Driver Assistance area of the Digital Display:

Active Cruise - Object Detected



Because ACC does not classify the forward object as a vehicle, Collision Mitigation braking will not occur (see Collision Mitigation); instead, this graphic is accompanied by an audible alert, allowing the operator to decide how to best respond to the detected object.

For more information on the characteristics of the Adaptive Cruise Control feature, please read the ADAS OEM Operator's Manual specific for your vehicle.

Collision Mitigation

 WARNING
<p>The driver must remain alert, react appropriately, and use safe driving practices while using this driver assistance feature. Ultimate responsibility for safe operation of the vehicle remains with the driver at all times. Failure to comply may result in death, personal injury, equipment damage, or property damage.</p>

 WARNING
<p>The driver must remain visually aware of the roadway and traffic and not rely solely on Drivers Assistance features to identify and respond to the variety of vehicles or objects sharing the road. The driver must read the ADAS opera-</p>

tor's manual associated with this feature and understand its limitations prior to driving the vehicle. Failure to comply may result in death, personal injury, equipment damage, or property damage.

 WARNING
<p>Driver Assistance features respond differently to specific road, weather, and traffic conditions. The operator must read the ADAS operator's manual associated with this feature and understand how it responds to these specific conditions prior to driving the vehicle. Failure to comply may result in death, personal injury, equipment damage, or property damage.</p>

Collision Mitigation (also Automated Emergency Braking) will attempt to prevent or lessen the impact of a forward collision where Collision Mitigation has determined impact with a pedestrian or a vehicle is likely. Although the Driver Assistance instrumentation can detect a non-vehicular

⁹ Following distance value may differ based on vehicle option codes.

or forward object, only a recognized pedestrian¹⁰ or vehicle can trigger Collision Mitigation.

Unlike Adaptive Cruise Control (ACC), Collision Mitigation is always on (at low speeds of 0mph to 35mph for pedestrians and at speeds greater than 15mph for vehicles) and does not depend on Cruise Control being active. When Collision Mitigation determines that a forward impact with a pedestrian or a vehicle is likely, Collision Mitigation will apply the service brakes and present the following warning in the Driver Assistance area of the display along with an audible warning:

Adaptive Cruise - Brake!

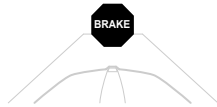

Additionally, this notification will appear instructing the operator to take control:



¹⁰ Not on all models.

Collision Mitigation should not be used to stop or slow the vehicle without operator intervention. A Collision Mitigation braking event will temporarily disable both ACC and standard Cruise Control, requiring these features to be reactivated by the operator.

Collision Mitigation will continue to slow down the vehicle until the potential for a collision has been averted, whether the potential collision be that the vehicle has triggered the braking event, or that the system has determined that another forward vehicle may likely impact. The operator can cancel the braking event by using either the accelerator pedal or the service brake. This lets Collision Mitigation know that the triggering event has been acknowledged.

To prevent abuse of this emergency braking feature, after three Collision Mitigation braking events, ACC and Collision Mitigation will be disabled until the next time the ignition switch is cycled. This is to prevent using Collision Mitigation irresponsibly or in a manner for which it was not intended. Please read the ADAS operator's manual specific for your vehicle to become familiar with the limitations of

Collision Mitigation (Automated Emergency Braking).

Predictive Cruise Control (Option)



Predictive Cruise Control (PCC) uses satellite technology and GPS maps to look at upcoming roads to dynamically calculate optimal fuel-efficient speed over a given terrain.

NOTE

There are many other factors that may influence the overall fuel economy of your vehicle (i.e., head wind and slope terrain, etc.).

Predictive Cruise Control operates similarly to standard cruise control. With PCC, vehicle speed is maintained without holding down the accelerator and can be used at 19 mph (30 km/h) or more. PCC will also actively recalculate and change the target cruising speed for best

fuel economy rather than maintaining a constant set speed. The range of the PCC target cruise speed is defined by an overshoot and undershoot speed values. These values are adjustable by the operator.

i NOTE

Adaptive Cruise Control (ACC) has the ability to override Eco cruise. This is because ACC is designed to decelerate the vehicle to match the speed of traffic in front of the ACC equipped truck.

PCC Behavior

As the vehicle approaches the top of a hill, PCC will decrease the vehicle speed (up to 8% below the set speed) to prevent the vehicle from exceeding the set speed while traveling downhill. This will result in a smoother, more fuel efficient ride as the vehicle approaches the crest of the hill. Once over the crest, momentum takes over and the system allows a predetermined amount of speed over the set speed. PCC can also activate Neutral Coast (NC) mode. NC mode disengages the vehicle's driveline, reducing fuel consumption while

maintaining overall vehicle speed. Once the vehicle can no longer maintain speed while coasting, NC is deactivated and the driveline re-engages.

If the driver has activated one of the vehicle's retarder systems (engine, transmission, or driveline), the vehicle speed may increase until it reaches the cruise control set speed plus the retarder offset. For more information about engine retarders, see your vehicle Operator's Manual.

If the vehicle drops outside the speed range, PCC will accelerate the vehicle back to the minimum PCC speed. As the vehicle reaches flat ground after the hill, PCC will maintain the set-speed until the crest of the next hill.

If the vehicle is equipped with Adaptive Cruise Control (ACC) and senses traffic slowing, it will overrule PCC and slow the vehicle. This event will cancel PCC only if the service brakes are required to slow the vehicle. If the service brakes are not used by ACC to maintain a safe following distance, PCC will remain engaged and resume automatically after the ACC event.

i NOTE

PCC was calibrated using a loaded vehicle. Your results may vary, depending on your vehicle's configuration.

PCC Interrupt

There are three conditions that will automatically deactivate PCC:

- If there is no data for the current road.
- If the GPS signal is lost.
- If the PCC system detects a fault.

When this happens, the vehicle will revert to standard cruise control. This CC state will be standard cruise control which will maintain the same cruise speed that was selected for PCC.

Once the system regains GPS signal and road data, PCC will resume.

i NOTE

PCC Map coverage will include most interstate and state highways.

Troubleshooting

The display will show a message if it detects an error with the PCC system. PCC faults may result from the unavailability of map, slope, vehicle position, etc. To effectively diagnose and clear the fault codes, the truck must be taken to your local dealership.

Fuel Economy Savings Not Achieved

Certain conditions may cause the optimal vehicle speed, calculated by PCC, to be overruled. For example, PCC will be overruled in the following scenarios:

- Greenhouse Gas functionality
- Adaptive Cruise Control Following Event (if equipped)
- Adaptive Cruise Control Error State (if equipped)

Disabling Predictive Cruise Control

To disable PCC and enable standard cruise control, the truck must be taken to an authorized dealer.

Software Information

The PCC ECU Software version and Map Data Version number can be found in the Menu [Truck Information](#) on page 75. It may

take up to two minutes for this information to be displayed after the truck has been keyed-on.

PCC Controls

PCC uses the same buttons as Cruise Control. See [Cruise Control](#) on page 167.

PCC Undershoot

Follow these steps to adjust the undershoot value for Predictive Cruise Control:

1. Press the **Toggle** twice.

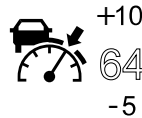

The bottom value below the set speed will illuminate.

2. Rotate the **Toggle** up or down to set the value.
3. Push the **Toggle** again to confirm the value.

If you want to set the Overshoot value, see [Predictive Cruise Control Overshoot](#) on page 71.

Lane Departure Warning (LDW)



WARNING

The driver must remain alert, react appropriately, and use safe driving practices while using this driver assistance feature. Ultimate responsibility for safe operation of the vehicle remains with the driver at all times. Failure to comply may result in death, personal injury, equipment damage, or property damage.



WARNING

The driver must remain visually aware of the roadway and traffic and not rely solely on Drivers Assistance features to identify and respond to the variety of vehicles or objects sharing the road. The driver must read the ADAS operator's manual associated with this feature and understand its limitations prior to driving the vehicle. Failure to comply may result in death, personal injury, equipment damage, or property damage.

**WARNING**

Driver Assistance features respond differently to specific road, weather, and traffic conditions. The operator must read the ADAS operator's manual associated with this feature and understand how it responds to these specific conditions prior to driving the vehicle. Failure to comply may result in death, personal injury, equipment damage, or property damage.

Using a windshield-mounted, forward facing camera, the Lane Departure Warning (LDW) feature monitors the road for lane markings and alerts the driver when the vehicle departs its lane without the use of the turn signal. Lane departure warning is only active at speeds greater than 37 MPH (60 km/h).

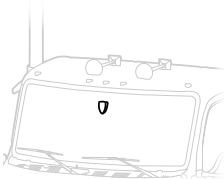

LDW is not available when the system cannot accurately detect lane markings; therefore, the camera should be clear of potential obstructions for the LDW feature to operate properly.

The following lists some conditions that can limit the performance of the features that use the camera:

- Buildup of dirt, mud, water, snow, ice, bugs, etc. on the windshield. These should be able to be resolved with proper use of the windshield washer/wiper system as the camera is intentionally installed in the wiper path.
- Windshield damage directly in front of the camera. This should be fixed as soon as possible.
- Items on the windshield like stickers, paint, window tint, etc. These should not be placed in front of the camera.
- Items on the exterior of the truck such as aftermarket visors, wind deflectors, hood ornaments, car racks, crane booms / hooks / buckets, snowplows, mirrors, etc.

The Driver Assistance area of the Digital Display indicates if the LDW system recognizes lane markings as follows:

- White lines indicate detected lanes.
- Gray lines indicate where the road is monitored for lane markings, but none are detected.
- Black lines mean that the LDW feature is disabled.
- A yellow line indicates an active lane departure event.

A lane departure event occurs when the vehicle tire crosses a lane marking without the use of the turn signal. A lane departure event is accompanied by an audible alert.

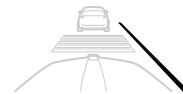
Lane Departure - Active

The LDW feature provides audible and visual alerts only and does not attempt to correct the vehicle's position in the lane. The operator can temporarily disable LDW (disabling audible and visual alerts) by using the dash mounted Lane Departure Warning Disable switch (See [Lane Departure Warning Disable](#)). For more information on Lane Departure Warning, see the ADAS OEM operator's manual specific for your vehicle.

Highway Departure Braking (option)



WARNING

The driver must remain alert, react appropriately, and use safe driving practices while using this driver assistance feature. Ultimate responsibility for safe operation of the vehicle remains with the driver at all times. Failure to comply may result in death, personal injury, equipment damage, or property damage.



WARNING

The driver must remain visually aware of the roadway and traffic and not rely solely on Drivers Assistance features to identify and respond to the variety of vehicles or objects sharing the road. The driver must read the ADAS operator's manual associated with this feature and understand its limitations prior to driving the vehicle. Failure to comply may result in death, personal in-

jury, equipment damage, or property damage.



WARNING

Driver Assistance features respond differently to specific road, weather, and traffic conditions. The operator must read the ADAS operator's manual associated with this feature and understand how it responds to these specific conditions prior to driving the vehicle. Failure to comply may result in death, personal injury, equipment damage, or property damage.

Highway Departure Braking (HDB) will slow the vehicle when the feature determines the vehicle has unintentionally left the roadway. HDB is only active at speeds above 37 mph (60 kph). When the midpoint of the vehicle crosses the solid white, outside lane line (also called the Fog Line) without use of the turn signal or hazards, HDB presumes an unplanned road departure and applies the service brakes. HDB will not bring the vehicle to a stop on its own (however, see Collision Mitigation), but is capable of

reducing vehicle speed by up to 30 mph (48 kph).

The digital display will notify the operator of a Highway Departure Braking event with a notification and show this graphic in the Driver Assistance area accompanied by an audible alert:



Highway Departure
BRAKE!

HDB works along with Lane Departure Warning (LDW). LDW can warn of a highway departure prior to the braking action taken during a HDB event (see Lane Departure Warning).

The operator can acknowledge and cancel a Highway Departure Braking (HDB) event by

- Applying the service brake and braking more than that applied by HDB.
- Pressing the accelerator pedal and pressing more than 90% of the pedal range.
- Activating the turn signal.
- Activating the hazards.
- Steering the vehicle back into the lane.

4

To prevent abuse of this feature, after six Highway Departure Braking events, HDB will be disabled until the next time the ignition switch is cycled. This is to prevent using HDB irresponsibly or in a manner for which it was not intended. Please read the ADAS OEM operator's manual specific for your vehicle for more information about Highway Departure Braking.

Speed Limit Recognition

Using the forward camera of your Driver Assistance instrumentation, your vehicle can read most North American speed limit signs. The detected, posted speed limit is presented on the display using a road sign located in the Driver Assistance area (see Minimized View with Driver Assistance):



When vehicle speed exceeds the posted speed limit by 5 mph (8 kph) or more, the operator is notified using alternating red and blue "cop" lights, indicating above the sign on the display. This is accompanied by an audible alert. Please read the ADAS OEM operator's manual specific for your vehicle for more information about Speed Limit Recognition.

Lane Keeping Assist (LKA)

 **WARNING**

The driver must remain alert, react appropriately, and use safe driving practices while using this driver assistance feature. Ultimate responsibility for safe operation of the vehicle remains with the driver at all times. Failure to comply may result in death, personal injury, equipment damage, or property damage.

 **WARNING**

The driver must remain visually aware of the roadway and traffic and not rely solely on Drivers Assistance features to identify and respond to the variety of vehicles or objects sharing the road. The driver must read the ADAS operator's manual associated with this feature and understand its limitations prior to driving the vehicle. Failure to comply may result in death, personal injury, equipment damage, or property damage.

 **WARNING**

Driver Assistance features respond differently to specific road, weather, and traffic conditions. The operator must read the ADAS operator's manual associated with this feature and understand how it responds to these specific conditions prior to driving the vehicle. Failure to comply may result in death, personal injury, equipment damage, or property damage.

Vehicles with Lane Keeping Assist (LKA) will provide steering assistance when the system detects the vehicle is departing the lane without the use of a turn signal. Using Torque Assisted Steering, LKA will steer the vehicle in an attempt to nudge the vehicle back into the lane. LKA can always be overcome by the operator.

 **NOTE**

The driver is expected to keep their hands on the steering wheel at all times.

Using this feature may increase or decrease awareness to components that are in need of inspection or maintenance, such as (but not limited to) improper tire inflation, suspension, or brake drag. The operator is informed that their vehicle is equipped with the Lane Keeping Assist feature at vehicle start using the following Pop-up notification:

Lane Keeping Assist Installed Pop-up

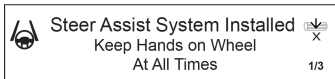

Additionally, when LKA is enabled or engaged, the Lane Keeping Assist Enabled/ Engaged indicator is present:

Lane Keeping Assist Enabled/ Engaged Indicator



(See [Lane Keeping Assist \(LKA\) Enabled/ Engaged](#) on page 92.)

When the vehicle speed is above 40 mph (65 km/h), the conditions are right, and the

system is ready to assist in keeping the vehicle in the lane, the steering wheel on the indicator will turn green, indicating that the system is active and ready to assist in lane keeping.

NOTE

Lane Keeping Assist will disengage if vehicle speed drops below the minimum speed setpoint of 31 mph (49 km/h).

When Lane Keeping Assist system operating conditions are not met, the LKA feature may disengage (the indicator will turn white), re-engaging once the operating conditions are again satisfied. Some of these conditions include an inability to identify lane markings, vehicle speed dropping below the minimum speed setpoint, rapid deceleration, or activating the vehicle hazard lights.

Lane Keeping can be disabled using the Lane Keeping Assist Disable switch, if optioned (see [Lane Keeping Assist \(LKA\) Disable \(option\)](#) on page 91).

For the LKA feature to safely operate, the driver must remain in control of the vehicle with their hands on the wheel. If the system

cannot detect the presence of the driver's hands on the wheel, it will disengage the LKA feature.

For more information on the Lane Keeping Assist feature, see the Lane Keeping Assist OEM operator's manual.

Torque Assisted Steering

The Torque Assisted Steering feature enhances the vehicle's traditional power steering, reducing the amount of effort required by the operator to steer the vehicle. As an option, Torque Assisted Steering also works with various optional enhanced driving features that improve safety and the overall driving experience (e.g. Lane Keeping Assist). Using electric motors coupled to the steering column, Torque Assisted Steering assists turning effort applied to the steering wheel, applying different levels of steering assistance dependent on driving conditions (e.g. vehicle speed and brake usage). Torque Assisted Steering is active when the engine is running with the parking brake released.

The amount of steering assistance provided by the Torque Assisted Steering feature can also be adjusted using the Torque Assisted Steering Effort Adjustment

switch (see [Torque Assisted Steering Effort Adjustment](#) on page 120).

Torque Assisted Steering does not replace the vehicle power steering, which remains active at all times. In the event that the Torque Assisted Steering feature deactivates or is disabled, the standard power steering system will not be affected, allowing the vehicle to be steered the same as a vehicle not equipped with the Torque Assisted Steering feature.

High Beam Assist (HBA)



WARNING

The driver must remain visually aware of the roadway and traffic and not rely solely on Drivers Assistance features to identify and respond to the variety of vehicles or objects sharing the road. The driver must read the ADAS operator's manual associated with this feature and understand its limitations prior to driving the vehicle. Failure to comply may result in death, personal injury, equipment damage, or property damage.

The High Beam Assist (HBA) is a function that aims headlights toward the road to support the driver by automatically controlling the high beams. The HBA system utilizes a forward-facing camera to detect the presence of other road users in front of the subject vehicle as well as detect ambient lighting conditions. A settings menu option is available to permanently enable and disable the HBA. If the HBA is set to **enabled** in the settings menu, the driver does not have to perform any further action to enable the HBA. The HBA will be enabled when the enablement conditions are met. The HBA selection made in the settings menu will persist through key cycles. However, the state of the HBA (i.e. disabled, enabled, driver override, etc.) will not. On startup, the HBA will always be disabled and not controlling the high beams until all of the enablement conditions have been met.



NOTE

The driver can override the HBA by pulling back on the Turn Signal lever.

There are two driver override states:

- If the HBA is controlling the high beams and the high beams are on, the driver can override the HBA and turn the high beams off by pulling back on the turn stalk. The high beams will remain OFF until the driver pulls back on the turn stalk again, which will return the control of the high beams to the HBA.
- If the HBA is controlling the high beams and the high beams are off, the driver can override the HBA and turn the high beams on continuously by pulling back on the turn stalk. The high beams will remain ON continuously until the driver pulls back on the turn stalk again, which will return control of the high beams to the HBA.



NOTE

Regardless of the state of the high beams and the HBA, the driver will always have flash-to-pass functionality by pushing forward on the Turn Signal lever.

The HBA may not function correctly in the following situations and your intervention may be necessary:

- In strong weather conditions like dense fog or heavy precipitation.
- In the presence of poorly lit traffic participants like cyclists, pedestrians, or animals.
- In tight curves, at hilltops or depressions, at intersections.
- In poorly lit built-up areas, in the presence of highly reflective signs or other unusual lighting conditions.
- When the windshield in front of the camera is fogged, dirty, or otherwise obscured.

If there is a problem with the HBA, the following notification will appear on the Digital Display indicating that inspection or service must be performed.

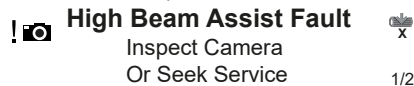

Activating the High Beam Assist (HBA)

To activate the High Beam Assist (HBA) feature, perform the following procedure:

1. Go to the Main Menu in the Digital Display.
2. Select the **Settings** option.
3. Select the **General** option.
4. Scroll down until you see the **Features** section.
5. Scroll down, select **Automatic High-Beam**, and set this feature to the **ON** position.

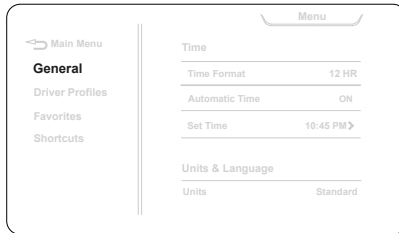
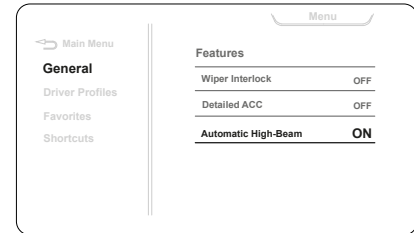
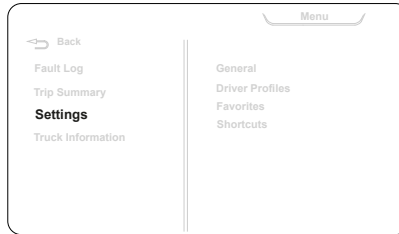

Hands Off Detection

 **WARNING**

The driver must remain visually aware of the roadway and traffic and not rely solely on Drivers Assistance features to identify and respond to the variety of vehicles or objects sharing the road. The driver must read the ADAS operator's manual associated with this feature and understand its limitations prior to driving the vehicle. Failure to comply may result in death, personal injury, equipment damage, or property damage.

The Hands Off Detection (HOD) is a feature that detects when the driver's hands are not on the wheel.

 **NOTE**

The HOD works independent of the LKA.

 **NOTE**

LKA is not responsible for moving the vehicle back to its lane. The driver must remain in full control of the vehicle at all times.

When the driver is properly operating the vehicle with driver control of the steering wheel, the arms will be white. When the driver removes their hands from the steering wheel for a certain period, the arms on the LKA icon will change color and there will also be notification messages along with audible alerts stating warnings depending on how long the driver's hands were off.

Time With Hands off	Color in Arms	Message Displayed
10 seconds	Amber	Steering Assist System Installed, Keep Hands on Wheel At All Times

Time With Hands off	Color in Arms	Message Displayed
15 seconds	Red	Keep Hands on Wheel, Steering Assist will Disable!
30 seconds	Red	Driver Take Control
60 seconds	Grey	Steering Assist Disabled, Driver Take Over

 **NOTE**

After 60 seconds with the hands off, the LKA system will disengage and the audible alert will continue until the driver has taken control of the steering wheel again. When the driver takes control of the steering wheel again, the system will return to its enabled state.

Engine Fan Control

The engine fan switch on the dash has a manual and an automatic mode. In the manual mode, the engine fan will engage until the switch is back into automatic mode. In automatic mode, the engine fan operation is controlled by the engine computer.



WARNING

DO NOT work on or near the fan with the engine running. Anyone near the engine fan when it turns on could be injured. If it is set at MANUAL, the fan will turn on any time the ignition key switch is turned to the ON position. In AUTO, it could engage suddenly without warning. Before turning on the ignition or switching from AUTO to MANUAL, be sure no workers are near the fan. Failure to comply may result in death or personal injury.



CAUTION

DO NOT operate the engine fan in the MANUAL position for extended periods of time. The fan hub was designed

for intermittent operation. Sustained operation will shorten the fan hub's service life as well as reduce fuel economy. Failure to comply may result in equipment or property damage.



CAUTION

The fan or equipment near it could be damaged if the fan turns on suddenly when you do not expect it. Keep all tools and equipment away from the fan. Failure to comply may result in equipment or property damage.

Using a Winterfront



CAUTION

The use of a winterfront can result in excessive coolant, engine oil, and intake air temperatures, which may lead to overheating and possible engine damage.



CAUTION

A winterfront should only be used at temperatures below 40°F (4°C). Use of a winterfront above 40°F (4°C) can decrease life of cooling module components. Remove winterfront as soon as the ambient temp reaches 41°F (5°C). The use of a winterfront above 40°F (4°C) can result in excessive coolant, engine oil, and intake air temperatures, which may lead to overheating and possible engine or coolant module damage and emissions non-compliance.

The winterfront is designed to minimize the temperature differences across the radiator and reduce the possibility of cooling module damage. Aftermarket winterfronts may not provide the proper airflow distribution and could cause cooling module damage.

How to Set the Shutdown Timer

The Shutdown Timer must first be enabled. Enabling the shutdown timer is located in the Settings Sub-menu.

Follow these steps to turn on the engine idle shutdown timer. The shutdown timer will default to 5 minutes (or the last value used) and can be set up to 30 minutes unless limited by the Engine Shutdown System (*Clean Idle* on page 350).



WARNING

Never idle your vehicle for prolonged periods of time if you sense that exhaust fumes are entering the cab. Investigate the cause of the fumes and correct it as soon as possible. If the vehicle must be driven under these conditions, drive only with the windows open. Failure to repair the source of the exhaust fumes may result in death, personal injury, equipment or property damage.



CAUTION

DO NOT idle the engine for excessively long periods. Long periods of idling,

more than 10 minutes, can cause poor engine performance.

1. Using the **Scroll Wheel**, target the number of minutes and press **Select**.
2. **Back** to return to the Settings menu.

Engine Aftertreatment System

This vehicle has an engine aftertreatment system (EAS) to control vehicle exhaust emissions. The EAS consists of the following:

- Diesel Particulate Filter (DPF)
- Selective Catalytic Reduction (SCR)
- Diesel Exhaust Fluid (DEF) filter
- DEF coolant filter
- DPF switch
- Warning lights

The DPF will trap soot from the engine exhaust gases. The SCR uses Diesel Exhaust Fluid (DEF) to reduce the levels of

Nitrogen Oxides (NOx) in the engine exhaust. The EAS will periodically clean (regenerate) the DPF.

If your vehicle is equipped with a Compact Twin canister, a 48 V generator will be located between the engine flywheel and the transmission clutch.



CAUTION

DO NOT use the 48 V cables or coolant lines attached to the 48 V generator as a support to perform an inspection or work under the vehicle. This will damage the cable connectors or coolant lines. Failure to comply may result in equipment or property damage.

Please refer to the Engine Aftertreatment System Supplement provided with the vehicle for a more detailed description of functionality and warnings.

Lighting

Lighting Switches

Headlights/Parking

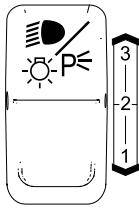

Marker

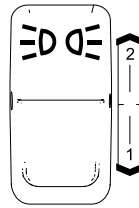

Hazard Warning

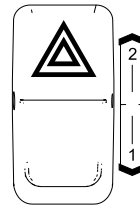

Exterior Lights Self-Test (ELST)

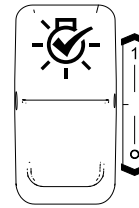

Dome

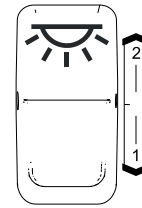

Dome Light

Turns on cab interior overhead light. See [Lights, Dome](#) on page 115.

ELST

Starts an Exterior Lights Self Test. See [Exterior Lighting Self-Test \(ELST\)](#) on page 115.

Hazard Lights

Turns on Hazard Warning Lights. See [Lights, Hazard](#) on page 117.

Headlights/Parking

Three-position switch that activates either the parking lights, or the headlights *and* the parking lights. See [Lights, Combined Headlights/Parking Lights](#) on page 115.

NOTE

The high beams and flash-to-warn activation methods use the same action. To activate the high beams, turn the low beams ON. To activate flash-to-warn, turn the low beams OFF.



WARNING

If the vehicle's low beam wiring circuit does not function correctly, pull completely off the road and call the nearest dealer for assistance. **DO NOT** drive the vehicle using the high beams, as high beam glare can blind other drivers and increase the risk of an accident. Failure to comply may result in death, personal injury, equipment damage, or property damage.

Marker Lights

Legally required driving lights that inform motorists to the height, width, and length of the vehicle. See [Lights, Marker/Clearance](#) on page 117.

Optional Lighting Switches



[Lights, Beacon](#) on page 114.



[Lights, Daytime Running \(Override\)](#) on page 115.



[Lights, Fog](#) on page 116.



[Lights, Marker/Clearance/Trailer](#) on page 117.



[Lights, Sleeper Dome \(option\)](#) on page 118.



[Lights, Spot](#) on page 118.



[Lights, Work](#) on page 118.



[Lights, Flood \(Spare\)](#) on page 116.

Headlight flashing

- **Flash-to-Warn** (or High Beams Flash) - Warn other drivers by briefly activating high beam headlights. See [Flash-to-Warn](#).
- **Flash-to-Pass** (sometimes called Low Beams Flash) - Signal other drivers by briefly changing headlight intensity. See [Flash-to-Pass](#) on page 97.
- **Flash-to-Thank** (or Marker Lights Flash) - Signals other drivers by briefly flashing the marker lights. See [Flash-to-Thank](#) on page 96.

Transmission

Transmission Tips

Riding the Clutch

The clutch is not a footrest. DO NOT drive with your foot resting on the clutch pedal. It will allow the clutch to slip, causing excessive heat and wear, damage could result.

Release Bearing Wear

When idling the engine, shift the transmission to neutral and disengage the clutch by removing your foot from the pedal. Disengaging the clutch in idle prevents unnecessary wear to the clutch release bearing and is less tiring for drivers.

More Tips

- Always use the clutch when making upshifts or downshifts.
- Always select a starting gear that provides sufficient gear reduction for the load and terrain.
- Never downshift when the vehicle is moving too fast.

- Never slam or jerk the shift lever to complete gear engagement.
- Never coast with the transmission in neutral and the clutch disengaged. To provide smooth gear engagements while shifting, use proper coordination between shift lever and clutch.
- Double clutching is a very effective means to increase the service life of the transmission. Double clutching refers to a technique where the clutch pedal is used twice per shift instead of once. It also requires that you adjust the engine rpm in the middle of the shift which ultimately synchronizes the gears during shifting. Synchronizing reduces wear on the gears.

Operating Manual Transmissions

The transmission shift pattern for your vehicle may be located on the shift control knob. In addition to understanding the shift pattern and its location, you should read the transmission manufacturer's manual provided with your vehicle before operating the vehicle. After making sure the vehicle's oil and air pressure are correct and all

other parts and systems are in proper working condition:

1. For vehicles with a clutch pedal, locate the clutch pedal and engage the clutch brake.
2. Shift into a low gear.



CAUTION

Always use first gear or a low speed range to start the vehicle in motion. The use of a higher gear or speed range forces undue strain on the engine, clutch, and other transmission components, and may cause damage.

3. Evaluate the road surface conditions and terrain. Select a gear low enough to let the vehicle start forward with the throttle at idle.
4. Push the parking brake valve handle (yellow) against the dash panel to release the brake.
5. Release the clutch pedal (manual only), then gradually accelerate to permit smooth starting.
6. DO NOT allow the vehicle to roll (even a little) in the opposite direction during clutch

engagement. When starting on an incline, apply the service brakes before releasing the parking brake. Then, release the service brake as you engage the clutch and apply throttle.

For further instructions on operating the transmission, see the transmission manufacturer's Driver/Operator's Instruction Manual.

To shift directly into any gear other than first or reverse, depress the clutch pedal only far enough to release the clutch. Fully depressing the pedal applies the clutch brake and could cause gear hang-up. If the vehicle has a misaligned gear condition and cannot start, gradually release the clutch, allowing the drive gear teeth to line up properly. Then the drive gear can roll enough to allow the teeth to line up properly and complete the shift. The best engine performance and maximum economy is obtained if gears are properly selected. This efficiency is achieved by always selecting gears within optimum engine rpm, which is where maximum torque and power are obtained. Shift carefully in a new vehicle. The transmission may be a little stiff at first. Avoid gear clashing by closely following these procedures. When you are operating

a new vehicle or one that has been exposed to cold weather, you want the transmission lubricant (fluid) to circulate and coat the contacting surfaces of the gears. Metal contacting metal in moving parts may seriously damage your transmission, do not drive in one gear for long periods of time until the transmission lubricant has a chance to coat all contacting surfaces.

- Always select a starting gear that will provide sufficient gear reduction for the load and terrain.
- Never downshift when the vehicle is moving too fast.
- Never slam or jerk the shift lever to complete gear engagement.
- Never coast with the transmission in neutral and the clutch disengaged.

How to Use the Hydraulic Clutch



CAUTION

Be careful not to apply the clutch brake while the vehicle is moving. The purpose of the clutch brake is to stop the transmission so that you can shift

into a starting gear without grinding gears. Applying the clutch brake when the vehicle is moving causes a braking effect on the drivetrain and shortens the service life of the clutch brake.



CAUTION

DO NOT push the clutch pedal completely to the floor when shifting while the vehicle is in motion. using the clutch brake while shifting a vehicle in motion will damage the clutch brake. A non-functioning clutch brake will make shifting very difficult when the vehicle is stationary.

1. Depress the clutch pedal past the first 1/2 in. (13 mm) for approximately 5 1/2 in. (139.7 mm) of total pedal travel.
2. Depress the clutch pedal another 1/2 in. (13 mm) to engage the clutch brake.

The clutch brake is used for stopping transmission gears, allowing shifting into first gear or reverse without grinding gears. The clutch brake is not necessary when shifting into other gears while in motion.

If the clutch pedal is pressed completely to the floor, and the transmission is not shifting, it is time to have the clutch adjusted or serviced.

If the transmission has a butt-tooth condition and you cannot engage a gear, gradually release the clutch. Then the drive gear can roll enough to allow the teeth to line up properly and complete the shift.

The clutch is not a footrest. Do not drive with your foot resting on the clutch pedal. It will allow your clutch to slip, causing excessive heat and wear. Damage could result.

When idling the engine, shift the transmission to neutral and disengage the clutch by removing your foot from the pedal. Disengaging the clutch in idle prevents unnecessary wear to the clutch release bearing and is less tiring for drivers.

- Always use the clutch when making upshifts or downshifts.
- Never coast with the transmission in neutral and the clutch disengaged.
- To provide smooth gear engagements while shifting, use proper coordination between shift lever and clutch.

How to Shift Using Double Clutch Method

Double clutching is easier on the transmission and on the engine, helping match the vehicle's engine speed with driveline speed to achieve clash-free shifts. The manual transmission in the vehicle is not equipped with gear synchronizers. Whether you are upshifting or downshifting, it is best to double clutch. To double clutch:

1. Push the clutch pedal down to disengage the clutch.
2. Move the gear shift lever to neutral.
3. Release the pedal to engage the clutch. This lets you control the rpm of the transmission mainshaft gears, allowing you to match the rpm of the mainshaft gears to those of the output shaft.
 - Upshifts: let the engine and gears slow down to the rpm required for the next gear.
 - Downshifts: press accelerator, increase engine and gear speed to the rpm required in the lower gear.
4. Now quickly press the pedal to disengage the clutch and move the

gear shift lever to the next gear speed position.

5. Release the pedal to engage the clutch.

Automated Transmissions

This vehicle may have a PACCAR TX-12/ TX-18 or Eaton Endurant automated transmission. It remains important to completely understand how to operate the transmission to optimize its efficiency. Please read the manual for the automated transmission included with your vehicle. Not all automated transmissions have a "park" position, so you will need to apply the parking brake before leaving the cab.



WARNING

If your vehicle has an automated transmission, the vehicle can roll backwards when stopped or started on a hill or grade. To prevent rolling, observe the following guidelines:

- When stopped on a hill or grade, press the brake pedal.
- When starting from a stop on a hill or grade, quickly remove your foot from the brake pedal

and firmly press on the accelerator pedal.

Failure to comply may result in death, personal injury, equipment damage, or property damage.



WARNING

DO NOT leave the cab of the vehicle without applying the parking brake. The vehicle could roll and cause an accident resulting in death or personal injury. Always apply the parking brake before you leave the cab.

Hill Hold



The hill hold feature is available as an option with certain automated transmissions. This feature holds the vehicle while on a hill to allow the operator to release the service brakes and press the accelerator. This feature will hold the vehicle if the vehicle is attempting to go up a hill from a stop in either drive or reverse. There is usually a switch associated with defeating this hold feature, should it be

desirable to intentionally roll back, such as down a loading ramp for example.

Shift Configuration

Some transmissions are equipped with more than one shifting configuration to match various operating conditions. Please read the automated transmission manual included with your vehicle for instructions on how to change shift configurations.

When the transmission is in an alternate configuration, there is usually some kind of indication near the gear graphic. The letters 'C2' may appear, for example, or words describing the configuration such as "Tanker" or "Off-Road".

Transmission Gear Display



This indicator shows the transmission mode and current gear. This display location does not apply to vehicles with Allison automatic transmissions.

- Max mode
- Low gear mode
- Manual Mode
- Neutral Coast
- Driver Shift Aid
- Configuration 2

Inside the gear icon, the indicator normally shows the current gear number and may at times show:

- **AN** - Auto Neutral
- **CA** - Clutch Abuse
- **GI** - Grease Service Interval
- **!** - Error State

Transmission Error



This icon indicates an error in the transmission. Attempt to reset the transmission by switching off the vehicle. After two minutes, restart the engine. Then see if the same icon appears in the display. Contact the nearest authorized dealership if the condition persists.

Controls for Vehicles with a PACCAR TX-12/TX-18 or Eaton Endurant Transmission

This vehicle may be equipped with either a PACCAR TX-12/TX-18 or Eaton Endurant Transmission. The Automated or PACCAR Transmission controls are located on the right hand side of the steering column.

Using the Manual - Automatic Button

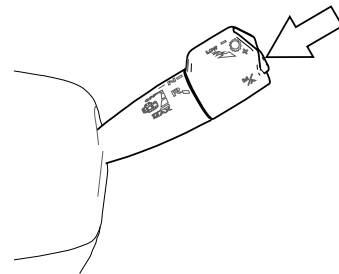

This button will put the transmission into manual mode. Manual mode will allow the operator to select the gear. See [Up or Down Shifting](#) on page 191.

To activate, put the gear selector in the **D** (drive) mode and then depress the **M/A** button. The instrument cluster will display the corresponding selection in the transmission mode area of the display. See [Drive, Neutral, and Reverse Indicator](#) on page 64.

Up or Down Shifting

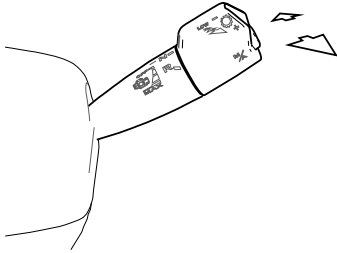

When in the Manual mode, the transmission gears can be manually selected by pushing or pulling on the lever. Pushing the lever forward will down shift. Pushing and holding the lever forward will engage the LOW gear range. Pulling the lever towards the driver will upshift the transmission.

Some vehicles may have a feature that prompts the operator to shift for optimal fuel economy.

If the prompt appears in the instrument cluster, use the manual gear selector lever to change gears.

Gear Shift Assist



The instrument cluster will illuminate with the corresponding gear.

Transmission Gear



Drive Neutral Reverse Selector

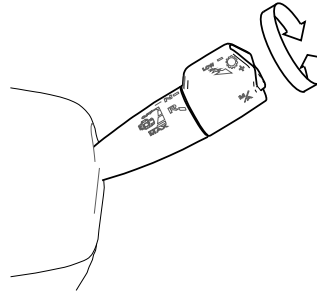

Transmission mode is selected by rotating the lever outer knob. There is a position for Drive (**D**), Neutral (**N**), and Reverse (**R**).

The Digital Display will indicate the corresponding mode. See [Drive, Neutral, and Reverse Indicator](#) on page 64.



NOTE

Selector (the transmission) must be in Neutral (**N**) to start the truck.

Auto-neutral



The Auto-neutral feature will automatically shift the transmission into Neutral if it is left in a forward or reverse mode (such as Low, Drive, or Reverse) and the parking brake is set. The transmission gear display shows **AN** when Auto-neutral is activated. This mode might also activate if the driver does not apply the foot brake before shifting. When this happens, the selector might have to be cycled with the correct brake application to perform the desired gear selection.



NOTE

If Auto-neutral has been activated, the transmission will not shift into Drive (**D**) or Reverse (**R**) until the shifter is first moved to Neutral (**N**) before selecting another transmission mode.

4

Neutral Coast Mode

Neutral Coast mode places the transmission into Neutral on slight downhill grades, improving fuel economy. Neutral Coast mode only operates when cruise control is active and the transmission is in Drive.

When Neutral Coast Mode is active, the engine will drop to idle speed and the transmission will disengage. The gear display shows a green **N** when Neutral Coast mode is active. The transmission exits Neutral Coast, returning to an appropriate gear, when the

- Vehicle brake is applied
- Operator depresses accelerator pedal
- A mode other than Drive is selected

- Operator performs an upshift or downshift request
- Cruise control is canceled
- Cruise high or low set speeds are exceeded
- Maximum vehicle grade is exceeded
- Driver Assistance systems (ADAS) make a brake request

Clutch Abuse Protection

The clutch can overheat and slip with improper use. Select the lowest possible start gear for the application.

- If moving slowly is required, select 1st or R1.
- Use the service brake and let Hill Start Aid assist you when launching on an incline.
- Do NOT use the throttle to hold the vehicle on an incline. (Use Service Brake).
- Do NOT use the throttle to stop roll back on an incline after Hill Start Aid disengages. (Use service brake, and then relaunch).

Transmission Gear Display (Clutch Abuse)



If the clutch starts to overheat, the transmission gear display will show **CA** and sound a warning tone. Full clutch actuation must be completed quickly. If not, the system will either open the clutch if not on the throttle or close the clutch if on the throttle. If the abuse continues, the system will open the clutch and take away throttle control for a short period of time to allow the clutch to cool down.

Automatic Transmissions

An automatic transmission makes shifting much easier. It remains important to completely understand how to operate the transmission to optimize its efficiency. Please read the manual for your automatic transmission included with your vehicle.

**WARNING**

DO NOT leave the cab of the vehicle without applying the parking brake. The vehicle could roll and cause an accident resulting in death or personal injury. Always apply the parking brake before you leave the cab.

Auxiliary Transmission

If you have an auxiliary transmission, see your transmission manufacturer's manual for its proper operation.

Brakes**Air Brake System****WARNING**

DO NOT drive through water deep enough to wet brake components, as it may cause the brakes to work less efficiently than normal. The vehicle's stopping distance may be longer than

expected, and the vehicle may pull to the left or right when brakes are applied, which could contribute to an accident involving death or personal injury.

Compressed air is delivered to the brake system through the valve at the brake pedal and is controlled with various valves and braking circuits. The brake system is designed with separate front, rear, and (when applicable) trailer circuits so that if one circuit is compromised and loses air, the other circuits will not be affected. Safety valves in each circuit will protect the other circuits in the event that a circuit loses air.

The air compressor on the engine will typically provide 100-130 psi (690-896 kPa) to the air tanks. The vehicle is also designed with an air dryer, which removes moisture from the compressed air in order to protect all components in the air system. The brake system may be further enhanced by additional devices such as brake proportioning valves, antilock braking systems, or sensors designed to let you know if your brake pads need to be serviced. Certain conditions may result in the brake surfaces getting wet. Brake surfaces that are wet do not perform as

well as when they are dry. There may be situations where wet brake surfaces cannot be avoided. In such situations, apply the brakes while in motion, to dry the brake surfaces.

Certain conditions may result in your brake surfaces becoming overheated (above 800°F or 427°C). Overheated brakes will damage linings and drum surfaces, ultimately decreasing brake performance. Refer to Retarders and Descending a grade to avoid overheating the brakes.

Parking Brake

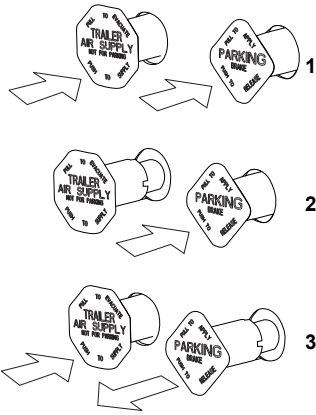

1. Normal run position
2. Trailer park with vehicle released
3. System park or trailer charge with vehicle parked

Commercial Truck Parking brake works in reverse action of automotive hydraulic brakes. When the parking brake is engaged, air is exhausted from the spring chambers, which allows the spring to engage the brake. This design also provides a safety function if a brake circuit

has a leak and loses air. In such a scenario, the parking brake will apply. The vehicle's parking brake controls are the yellow diamond shaped knob on your dash board. If the vehicle is equipped to tow a trailer, then there will be an additional red octagon shaped knob for the trailer parking brake. The parking brake will be engaged when either of these knobs are pulled OUT. (If one knob is pulled out, the other knob will automatically pop out.) Pushing IN a knob will disengage the respective parking brake. If you push in the yellow knob only, you will disengage the vehicle's parking brake but will not disengage the trailer parking brake (if applicable). Either knob will pop back out if the system pressure is not above 60 psi (414 kPa). The instrument panel display will provide a message any time the parking brake (vehicle or the trailer) are set and the vehicle is put into motion.

Engage Trailer Hand Brakes

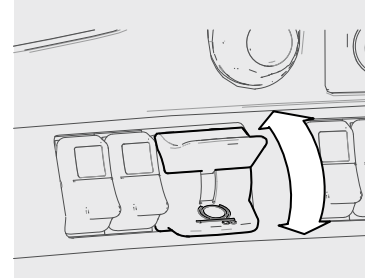

Press the lever down to engage the Trailer Hand Brake. If the brake does not self release, raise the lever back up manually to disengage the Trailer Hand Brake.

Automatic Traction Control



The truck-tractor antilock brake system (ABS) has an Automatic Traction Control (ATC) feature. A switch on the dash controls this feature. Check for illumination of the ABS and traction control warning lamps when first starting the vehicle. Monitor these lamps while driving. Other

than these provisions, there are no special operating procedures required. For a detailed system description, see the literature for the specific ABS that came with the vehicle.

**NOTE**

Do not allow the traction control lamp to remain on continuously for an extended length of time. Continuous use of the ATC can cause overheating of the drive wheel brakes. Reduce the engine torque or vehicle speed to eliminate wheel spin.

Antilock Brake Systems (ABS)

This vehicle can have an Antilock Brake System (ABS). The ABS adjusts air pressure at the appropriate wheels to prevent wheel lock-up. The ABS arms when the ignition switch is on.

**WARNING**

The antilock brake system (ABS) is a critical vehicle safety system. For the safety of you and others around you, have the vehicle submitted for periodic

preventive maintenance checks. If you suspect problems, immediately contact an authorized dealer. Failure to maintain the brake system properly can lead to serious accidents. Failure to comply may result in death, personal injury, equipment damage, or property damage.

**WARNING**

DO NOT rely on an antilock brake system that is functioning improperly. You could lose control of the vehicle resulting in a severe accident, causing personal injury or death. If your ABS lamp goes on while you are driving or stays on after the self-check, your antilock system might not be working. The ABS may not function in an emergency. You will still have conventional brakes, but not antilock brakes. If the lamp indicates a problem, have the ABS checked. Failure to comply may result in death, personal injury, equipment damage, or property damage.

Vehicles without ABS are typically equipped with a bobtail brake proportioning system. When a trailer is not connected,

the drive axle brake application pressure will automatically be limited by the proportioning system. When driven in a bobtail mode, these tractors will require greater brake pedal application to provide the equivalent braking to a bobtail tractor not equipped with a proportioning system.

Trailer ABS Power Line Communication (PLC)

North American on-highway vehicles are equipped with a separate electrical circuit to power the ABS on towed vehicle(s). In most cases, the ABS power will be supplied through the Auxiliary circuit on the primary 7-way trailer light line connector. If the vehicle was manufactured with a switchable Auxiliary circuit for trailer accessories, an additional 7-way connector would have been provided for trailer ABS power. In either case, the ABS power line on the vehicle will be PLC equipped.

**WARNING**

DO NOT splice into the non-switchable Auxiliary circuit on the primary 7-way trailer light line. Doing so may cause the trailer ABS to malfunction. This circuit is dedicated for trailer ABS power. To add a switchable auxiliary circuit, contact a dealership. Failure to comply may result in death, personal injury, equipment damage, or property damage.

**NOTE**

Tractors/trucks and trailers built after 03/01/2001 must be able to turn on an In-Cab Trailer ABS Warning Light (per U.S. FMVSS121). The industry chose Power Line Communication (PLC) as the standard method to turn it on. On trailers built prior to 03/01/2001, verify trailer ABS system status via the required external warning light mounted on the trailer. The indicator light on the trailer should be amber and identified with the letters ABS.

For doubles or triples, the lamp does not distinguish between trailers. An ABS problem in any of the trailers will activate the Trailer ABS Warning Lamp. If you change the intended service in any way (for example, number of axles, multiple trailers, add switchable trailer accessories, etc.) from the date the vehicle was manufactured, you should contact your trailer manufacturer, your trailer antilock brake manufacturer, or both to determine if the power available at the 7-way trailer light line is adequate. Failure to do so might result in insufficient power to the trailer ABS system, which may affect its operation.

**NOTE**

The center pin of the 7-way trailer light line may be constantly powered for ABS. Make sure it will not accidentally turn on trailer equipment.

Special Trailer ABS Without PLC (Option)

If a trailer does not have Power Line Communication (PLC), but it does have Anti-Lock Brake Systems (ABS) that is powered through an optional second trailer

connector (ISO 3731) and that trailer ABS is designed to control the Trailer ABS Warning Lamp in the cab and the vehicle has been ordered with the option to turn on this lamp for these types of trailers, then this lamp will turn on when that trailer ABS has a system problem. This should be checked by a dealer as soon as possible. The Trailer ABS Warning Lamp will not turn on for the power-on test when connected to these types of trailers.

**NOTE**

Very few trailers built before 03/01/2001 have this option. Trailers built after 03/01/2001 are built with PLC technology.

Advanced ABS With Stability Control

Advanced ABS with Stability Control is a feature that reduces the risk of rollovers and other loss of control situations. For vehicles towing trailers, the feature can reduce the risk of a trailer jack-knifing. During operation, the system constantly compares performance models to the vehicle's actual movement. It uses the

wheel speed sensors of the antilock brake system (ABS), and lateral, yaw, and steering angle sensors. If the vehicle begins to leave the appropriate travel path, the system intervenes to assist the driver.

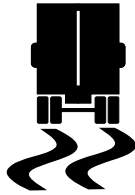

Electronic Stability Control can reduce the vehicle speed automatically. To minimize unexpected deceleration and reduce the risk of a collision, the operator must:

- Avoid aggressive driving maneuvers, such as sharp turns or abrupt lane changes at high speeds, which can trigger the stability system.
- Always operate the vehicle safely. Drive defensively, anticipate obstacles and pay attention to road, weather, and traffic conditions. ABS, ATC, and ESC stability systems are no substitute for prudent, careful driving.

Roll Stability

Y53-1200-1L1 (05/2024)

A Real World Example of How the System Operates

Excessive speed for road conditions creates forces that exceed the threshold at which a vehicle is likely to roll over on a higher-friction surface. The system automatically reduces engine torque and applies the service brakes (based on the projected rollover risk) to reduce the vehicle speed, thereby reducing the tendency to roll over.

Roll Stability Example

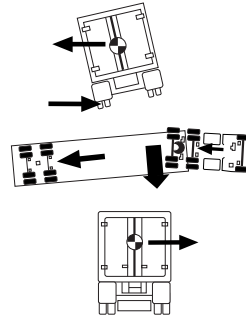

Yaw Stability

Yaw stability counteracts the tendency of a vehicle to spin about its vertical axis.

During operation, if the friction between the road surface and the tires is not sufficient to oppose lateral (side) forces, one or more of the tires can slide, causing the truck/tractor to spin. These yaw events are referred to as either "under-steer" (where there is a lack of vehicle response to steering input due to tire slide on the steer axle) or "over-steer" (where the tractor's rear end slides out due to tire slide on the rear axle) situation. Generally, shorter wheelbase vehicles (tractors, for instance) have less natural yaw stability, while longer wheelbase vehicles (straight trucks, for instance) have greater natural yaw stability. Factors that influence yaw stability are: wheelbase, suspension, steering geometry, weight distribution front to rear, and vehicle track width.

Yaw Control

Yaw Control responds to a wide range of low- to high-friction surface scenarios including rollover, jackknife and loss of control. In the case of vehicle slide (over-steer or understeer situations), the system will reduce the throttle and then brake one or more of the "four corners" of the vehicle (in addition to potentially applying the trailer brakes), thus applying a counterforce to better align the vehicle with an

appropriate path of travel. For example, in an over-steer situation, the system applies the "outside" front brake; while in an under-steer condition, the "inside" rear brake is applied.

A Real World Example of How Yaw Control Operates

Excessive speed exceeds the threshold, creating a situation where a vehicle is likely to spin and, where applicable, jackknife. The system reduces engine throttle and selectively applies brakes to reduce the vehicle speed, thereby reducing the tendency to jackknife.

Yaw Control Example

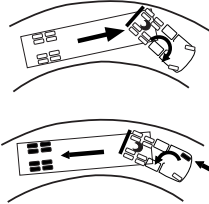

Automatic Traction Control



Your truck/tractor ABS has an automatic traction control (ATC) feature. This feature is controlled by a switch. This feature is monitored by a warning lamp located on the switch. The Traction Control warning lamp will briefly illuminate and then go out when the ignition switch is first turned on. The traction control warning lamp will illuminate whenever the ATC system detects drive wheel spin. The lamp will remain illuminated as long as wheel spin is detected and the ATC system is applying the drive wheel brakes or reducing engine torque. Engine torque or vehicle speed should be reduced to eliminate wheel spin and prevent excessive application of the ATC system.

Except for checking for proper illumination of the ABS and traction control warning lamps when first starting the vehicle, and for monitoring these lamps while driving, no special operating procedures are required. For detailed system description,

see literature for your specific ABS that was provided with your vehicle. This feature helps improve traction when vehicles are on slippery surfaces or surfaces with poor traction (for example, mud or snow) by reducing drive wheel overspin. Automatic traction control works automatically in two different ways:

- If a drive wheel starts to spin, *Automatic Traction Control (ATC)* applies air pressure to brake the wheel. This transfers engine torque to the wheels with better traction.
- If all drive wheels spin, reduces engine torque to provide improved traction.

turns itself ON and OFF. If drive wheels spin during acceleration, the warning lamp comes ON, indicating wheel spin control is active.

Deep Snow and Mud Switch

A deep snow and mud switch is included with Automatic Traction Control (ATC). The Deep Snow and Mud feature is helpful during acceleration. This function increases available traction on extra soft surfaces like snow, mud, or gravel, by slightly increasing the permissible wheel spin. When this function is in use, the ATC Warning Lamp blinks continuously.

Off-Road ABS Function Switch (Optional)

The vehicle can have a separate switch to activate an off-road ABS function. Do not use this function for on-highway driving. Its intended use is to improve stopping performance in off-highway conditions (for example, loose gravel and mud). The off-road ABS function works by allowing a "wedge" of material to build-up in front of locked wheels.

- Changes the ABS control limits to allow for a more aggressive ABS function while off-road.
- Improves vehicle control and helps reduce stopping distances in off-road conditions. This feature also works on poor traction surfaces such as loose gravel, sand, and dirt.
- Allows retarders to function independently of the ABS function.
- If the vehicle does not have an engine retarder, the Off-road ABS switch functions the same.



WARNING

Off-road mode can improve vehicle control and shorten stopping distances.

ces. However, steering ability can suffer during its use on certain surfaces. This fact results from the momentary sliding of tires. Always operate the vehicle at safe operating speeds. Failure to do so can cause you to lose control of the vehicle. Failure to comply can result in death, personal injury, property damage, or unwarrantable equipment damage.



WARNING

Never drive the vehicle on improved roads and highways with the off-road ABS function switched on. When you drive the vehicle onto an improved road surface or highway, immediately turn off the off-road ABS switch. Failure to do so can cause the antilock brake system (ABS) not to function properly under 25 mph (40 km/h). This act could result in an accident or personal injury.

The ABS lamp flashes slowly during off-road mode engagement. This action is to alert you of a modification to the ABS control software. At speeds above 25 mph (40 km/h), the ABS controller operates in

the normal on-highway mode. At speeds between 10 mph and 25 mph (16 km/h and 40 km/h), the ABS control software allows short periods (0.25 seconds) of locked-wheel cycles. At speeds below 10 mph (16 km/h), the ABS control software switches off to allow locked wheels. When the off-road ABS function is active, the Retarder Disable output switches off. This action leaves the engine retarders to function without ABS intervention. For additional information, see the Off-Road ABS pamphlet in the vehicle's glove box.

Effectiveness and Limitations

ESC is designed and optimized for trucks and for tractors that tow single trailers. If a tractor equipped with ESC is used to power multiple trailer combinations (known as "doubles" or "triples") the effectiveness of the ESC system may be greatly reduced.



WARNING

Exercise extreme care when towing doubles or triples with a vehicle equipped with Electronic Stability Program. Excessive speed and aggressive maneuvers, such as sharp turns, sudden steering inputs or abrupt lane changes should be avoided because these maneuvers could cause loss of vehicle control possibly resulting in an accident involving death or personal injury.

Additionally, the ESC stability system's effectiveness may be greatly reduced if:

- The load shifts due to improper retention, accident damage or the inherently mobile nature of some loads (for example, hanging meat, live animals or partially laden tankers).
- The vehicle has an unusually high or offset center of gravity (CG).
- One side of the vehicle drops off the pavement at an angle that is too large to be counteracted by a reduction in speed.
- The vehicle is used to haul double or triple trailer combinations.

- If very rapidly winding steering inputs are inputted at high speeds.
- There are mechanical problems with suspension leveling of the tractor or trailer resulting in uneven loads.
- The vehicle is maneuvering on a high banked road creating either additional side forces due to the weight (mass) of the vehicle or a deviation between expected and actual yaw rates.
- Gusty winds are strong enough to cause significant side forces on the vehicle and any towed vehicles.

To maximize the effectiveness of ESC:

- Loads must be properly secured and evenly distributed at all times.
- Drivers need to exercise extreme caution at all times, and avoid sharp turns, sudden steering inputs or abrupt lane changes at high speeds, particularly if:
 - The vehicle hauls loads that could shift
 - The vehicle or load has a high or offset center of gravity (CG) when loaded
 - The vehicle tows doubles or triples

The ESC system was specifically calibrated and validated only for your vehicle's original factory-built configuration. If your vehicle's chassis components are altered (for example; a wheelbase extension or reduction, tag axle addition or removal, tractor to truck conversion or steering system component change) the ESC system must be disabled immediately by a qualified mechanic.



WARNING

Failure to disable ESC "Electronic Stability Control" when modifying a vehicle could result in a loss of vehicle control. This loss of control can result in an accident involving death or personal injury.

**WARNING**

For vehicles equipped with ESC (Electronic Stability Control) DO NOT replace the steering wheel with any model other than the one originally supplied. Use of an aftermarket wheel or wheel with a different part number could cause the ESC to malfunction, resulting in a loss of vehicle control. Failure to comply may result in death, personal injury, equipment damage, or property damage.

Whenever maintenance or repair work is performed to the steering mechanism, linkage, gear, adjustment of the wheel track, or if the steering angle sensor is replaced or the steering wheel is changed or re-centered, the Steering Angle Sensor must be re-calibrated.

**WARNING**

A certified technician must re-calibrate the Steering Angle Sensor after steering system maintenance. If the sensor is NOT recalibrated, the Yaw Control

system cannot function properly. An uncalibrated sensor could result in a loss of control of the vehicle. This potential loss of control can lead to an accident involving death or personal injury.

Towing Doubles or Triples Can Reduce the Effectiveness of Stability Systems

ESC works best for trucks, and for tractors that tow single trailers. If a tractor equipped with an ESC tows multiple trailer combinations (known as "doubles" or "triples"), it reduces the effectiveness of the ESC system.

**WARNING**

Exercise extreme care when towing doubles or triples with a vehicle equipped with Electronic Stability Program. Excessive speed and aggressive maneuvers, such as sharp turns, sudden steering inputs or abrupt lane changes should be avoided because these maneuvers could cause loss of vehicle

control possibly resulting in an accident involving death or personal injury.

Additionally, a significant reduction of the ESC effectiveness occurs if:

- The load shifts due to improper retention. Also, accident damage or the inherently mobile nature of some loads (for example, hanging meat, live animals or partially laden tankers).
- The vehicle has an unusually high or offset Center of Gravity (CG).
- One side of the vehicle drops off the pavement at an angle that speed reduction cannot compensate for.
- You use the vehicle to haul double or triple trailer combinations.
- If you apply rapidly changing steering inputs at high speeds
- There are mechanical problems with suspension leveling of the tractor or trailer resulting in uneven loads.
- If the vehicle maneuvers on a high-banked road, this action creates additional side forces due to the weight (mass) of the vehicle. It can

also cause a deviation between expected and actual yaw rates.

- Gusty winds are strong enough to cause significant side forces on the vehicle and any towed vehicles.

To maximize the effectiveness of ESC:

- Always properly secure, and evenly distribute the load.
- Drivers must exercise extreme caution always. Precautions must include: the avoidance of sharp turns, sudden steering inputs or abrupt lane changes at high speeds. This caution is important if:
 - The vehicle hauls loads that could shift
 - The vehicle or load has a high or offset Center of Gravity (CG) of when loaded
 - The vehicle tows doubles or triples

PACCAR tuned and validated the ESC system for the vehicle's original factory-built configuration only. It is possible to alter the vehicle's chassis components after purchase. Some examples include: a wheelbase extension or reduction, tag axle addition or removal, tractor to truck conversion or steering system change.



NOTE

If the vehicle configuration changes after purchase, the system calibration no longer applies. **The ESC system must be disabled immediately** by a qualified technician.



WARNING

Failure to disable ESC "Electronic Stability Control" when modifying a vehicle could result in a loss of vehicle control. This loss of control can result in an accident involving death or personal injury.



WARNING

For vehicles equipped with ESC (Electronic Stability Control) **DO NOT** replace the steering wheel with any model other than the one originally supplied. Use of an aftermarket wheel or wheel with a different part number could cause the ESC to malfunction, resulting in a loss of vehicle control.

Failure to comply may result in death, personal injury, equipment damage, or property damage.

When certain maintenance or repair work occurs, **the Steering Angle Sensor must be re calibrated**. Some maintenance actions that demand this are: adjustments of linkage, gear, or wheel track. Also when replacing the steering angle sensor, and when changing or re-centering the steering wheel.



WARNING

A certified technician must re-calibrate the Steering Angle Sensor after steering system maintenance. If the sensor is NOT recalibrated, the Yaw Control system cannot function properly. An uncalibrated sensor could result in a loss of control of the vehicle. This potential loss of control can lead to an accident involving death or personal injury.

Retarders

Various retarders are available, which function against the engine, driveline, or

transmission. These are devices that use the engine's power to slow down the vehicle. They reduce brake wear and tear and the need for continuous brake use, which can lead to the service brakes overheating. Ideally, you must always slow the vehicle with the retarder (where permitted by law) and use the service brakes only for stopping completely. Operating this way prolongs the life of the brakes.

**WARNING**

The service brakes must be used in an emergency. Retarders alone (engine brake, exhaust brake, or transmission retarder) might not stop the vehicle fast enough to prevent an accident. Failure to comply may result in death, personal injury, equipment damage or property damage.

**WARNING**

DO NOT use a retarder (engine brake, exhaust brake, or transmission retarder) when operating on road surfaces with poor traction (such as wet, icy, or

snow covered roads, or gravel). Retarders can cause the wheels to skid on a slippery surface. You could lose control of the vehicle or jackknife if the wheels begin to skid, resulting in an accident. Failure to comply may result in death, personal injury, equipment damage, or property damage.

The intent of the retarder is NOT to use as the primary brake for the vehicle, nor is it an emergency brake. The retarder only helps the service brakes by using pressure to slow the drivetrain. Use the service brakes for quick stops. Do not use the retarder when operating on road surfaces with poor traction (such as wet, icy, or snow-covered roads or gravel). Retarders can cause the wheels to skid on a slippery surface. PACCAR recommends not to use the engine retarder to slow down when you bobtail or pull an empty trailer.

**WARNING**

DO NOT use a retarder (engine brake, exhaust brake, or transmission retarder) when operating your vehicle bobtail

or with an unloaded trailer. There may not be enough weight on the rear axle to provide traction, causing a loss of vehicle control, resulting in an accident. Make sure the engine brake is switched "OFF" when bobtailing or operating with an unloaded trailer. Failure to comply may result in death, personal injury, equipment damage or property damage.

This vehicle can have a transmission retarder. Take your foot off the throttle. Then operate the retarder switch. When you do not need a full retarder effect, you can apply it intermittently (off and on) to cause gradual or partial slowing. Continuous application of the retarder causes the hydraulic fluid to get hotter. Intermittent application helps prevent overheating.





WARNING

DO NOT rely only on a retarder (engine brake, exhaust brake, or transmission retarder) to stop your vehicle. If your engine shuts down, the retarder will cease to operate. Always be ready to apply the service brakes. Failure to comply may result in death, personal injury, equipment damage, or property damage

4

Axle and Suspension

Differential Lock



The vehicle may be equipped with switches to lock the either of the rear axle differentials. Depending on how the vehicle is specified, a combination of individual switches may be available that can lock the interaxle driveline and/or any combination of the forward rear or rear-rear driving axles. The interaxle differential switch

allows each axle to turn independently. In certain situations, engaging the interaxle differential lock relieves stress on the rear axles and reduces tire wear. Engaging this switch will also provide better traction in slippery or loose gravel conditions. In the LOCK position, continuous operation on paved, dry surfaces, put stress on the axles, and can possibly damage the internal gears. The switch has a guard to prevent accidental operation of the switch. Locking the differentials is typically used during ice or snow conditions and without tire chains, unpaved roads that have loose sand, mud or uneven surfaces. Look ahead and predict when the differential needs to be locked. Stop the vehicle and lock the differentials before approaching. While using the differential in the locked position, do not exceed 25 mph (40 km/h). When disengaging the differential lock, reduce the throttle to prevent drivetrain damage.



WARNING

DO NOT put the differential lock in the LOCK position while the wheels are spinning freely (slipping), you could lose control of the vehicle or cause

axle damage. Switch to LOCK only when the wheels are not spinning. Failure to comply may result in death, personal injury, equipment or property damage.

Dual Range (Two-Speed) Rear Axle



Your vehicle may be equipped with a two-speed or dual range axle (option). The low range provides maximum torque for hauling heavy loads or traveling over rough terrain. The high range is a faster ratio for highway speeds and general over-the-road conditions. A switch on the accessory switch panel controls the dual range rear axle. The switch has a guard to prevent accidental activation. Always park your vehicle with the range selector in LOW. Important tips on operating a dual range axle with inter-axle differential:

- Shift the axle with the inter-axle differential in the unlocked position only.
- When you are driving with poor traction, lock the differential. When

you have the differential locked, drive with the axle in LOW range only.

- When you are driving on a surface with good traction, keep the inter-axle differential unlocked. You can drive with the axle in the LOW or HIGH range.
- Always UNLOCK the inter-axle differential before shifting the axle speed range.



WARNING

DO NOT shift the axle when moving downhill. Engine driveline disengagement may occur, eliminating engine retardation and allowing the wheels to spin faster than the current speed of the engine. This may require severe braking to slow the vehicle down and can result in an accident. Failure to comply may result in death, personal injury, equipment or property damage.



CAUTION

If you shift the axle range with the inter-axle differential in LOCK, you could seriously damage the axles. Never shift the axle range with the differential locked.

Proper shifting of the axle depends on the synchronization of engine/driveline and wheel speed. When you shift the axle, the connection between the engine and wheels is momentarily disengaged while the gearing is synchronized. Normally when the axle shifts the speed of the engine, axle, and wheels adjust, allowing for proper gear engagement. When the vehicle is going downhill, the wheels tend to speed up, which makes gear synchronization almost impossible. As a result, the axle is neither in HIGH nor LOW range and all engine/driveline retardation is lost. Without engine retardation, it is more difficult to slow the vehicle down and greater stress is put on the brake system.



CAUTION

To avoid damaging your vehicle, shift the axle at slower travel speeds until you are used to driving with a dual range axle.

How to Operate Two-Speed Axle - Low to High

These steps should be used if operating a two-speed axle in LOW range on rough terrain and preparing to drive on an improved surface.

When you go from rough terrain to highway driving, shift the axle to the HIGH range following this procedure:

1. Be sure the differential is UNLOCKED.
2. Maintain your vehicle speed (accelerator depressed) and move the Range Selector lever to HIGH.
3. Keep driving with the accelerator depressed until you want the axle to shift.
4. To make the axle shift, release the accelerator until the axle shifts. You are now in the HIGH axle range for highway speeds. Shift the

transmission normally to reach your desired cruising speed.

How to Operate Two-Speed Axle - High to Low

These steps should be used if operating a two-speed axle in HIGH range on improved roads and preparing to drive on rough terrain.

When you go from highway driving to rough terrain, shift the axle to the LOW range following this procedure:

1. Maintain vehicle speed (accelerator depressed) and move the Range Selector lever to LOW.
2. Keep driving with the accelerator depressed until you want the axle to downshift.
3. To make the axle downshift, release and depress the accelerator quickly to increase the engine rpm. The axle will shift to LOW range.
4. You are now in the LOW axle range for rough terrain and heavy loads. Shift the transmission normally to maintain the desired speed.

Auxiliary Axle

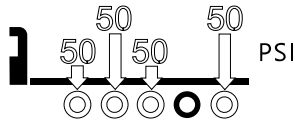

Adjustable auxiliary axles (commonly known as Pusher or Tag axles) can add to the productivity of the vehicle by increasing the load capabilities of the vehicle when they are in the deployed (down) position. There are different configurations of axles with different functionality (liftable versus steerable). Some configurations are capable of showing a pressure and/or position graphic on the instrument cluster that looks like the picture above matched to the axles on the vehicle. Without the extra axle, the excessive weight can reduce the service life of vehicle components such as, but not limited to, the frame rail, axles, suspension and brakes. Operation of the auxiliary axles includes the proper maintenance of the system and calibration of its controls. Operating the auxiliary axles will also require a firm understanding of the Gross Axle Weight Rating (GAWR) and the load that is being carried.

The vehicle will have switches on the dash to control the position of the auxiliary axles. In certain situations, however, the system will override the controls to protect the axle system. For Self Steering Lift Axles, the axle will raise when the park brakes are applied or if the vehicle is placed in reverse. For Non-Steer Lift Axles, the axle will only automatically raise if the park brakes are applied and there are no park brakes on the lift axle. Non-Steer Lift Axles do not automatically raise when the vehicle is placed in reverse.

Operating the auxiliary liftable axles must be performed in a manner that does not exceed the axle creep rating. Axle creep ratings are weight and speed limits that are allowed while the vehicle is fully loaded (in excess of the vehicle's standard GAWR) and the axle is in its up position. Axle creep ratings are assigned by the axle manufacturer and are based on axle model and intended service of the vehicle. Contact an authorized dealership if you are unable to identify the axle creep rating of this vehicle.

- Liftable/steerable (axle lift calibration required)
- Liftable/non-steerable (axle lift calibration required)

- Non-liftable (some suspensions require dump valve calibration)



WARNING

DO NOT operate or park the vehicle with auxiliary axles without park brakes in the down/loaded position when the vehicle is unladen, or is being unloaded as this could result in loss of vehicle control or roll-away. Raise or dump air into driver controlled auxiliary axle(s) without park brakes prior to unloading the vehicle. Failure to comply may result in death, personal injury, equipment damage, or property damage.

Adjustable Lift Axles

Vehicles with liftable AUX axles have knobs available to adjust the pressure in the AUX axle suspension. These knobs are in addition to the tag and pusher axle switches that control the axle position. Adding more pressure to the AUX axle increases the pressure the (AUX) axle pushes down. Increasing pressure decreases load on the drive axles and decreases traction. Decreasing pressure transfers more weight to the drive axles

and results in more traction from the drive axles.

Deflate the auxiliary (AUX) axle suspension before coupling or uncoupling a trailer. When initially coupled or uncoupled, increase pressure to balance traction and axle load requirements. Inflate air springs of the AUX axles to the desired pressure after coupling to a loaded trailer. Make sure that you maintain proper traction of the drive-axles.

To obtain the desired traction, adjust the pressure regulator control knob to a lower pressure. By reducing air pressure at the pusher or tag axle, you can transfer the load to the drive axles. Do not overload drive axles.

Always deflate the air springs of the AUX axles before attempting to unload the vehicle. This action allows maximum traction of the driving axles to control the vehicle.

Calibrations can change depending on the suspension. Contact an authorized dealer or axle/suspension manufacturer for specific calibration procedures.

Some suspensions require dump valve calibration. For example, some dead axles do not lift. You can dump the air out of them to unload them when empty. You

control air pressure via an adjustable regulator. Calibrate these axles for load. Contact an authorized dealer or axle/suspension manufacturer for dump valve calibration procedures.

Axle Creep Rating

Vehicles outfitted with auxiliary axles and full truck configuration will have an axle creep rating which defines how much load is allowed when the vehicle has a full load and maneuvering the vehicle, at very slow speeds, with auxiliary axles in the up position. In these situations, the load exceeds the gross axle weight rating of the axles.

Operators using vehicles equipped with liftable auxiliary axles must consider creep ratings when any liftable axle is unloaded or in the raised position. Liftable auxiliary axles should only be raised (or unloaded) to improve maneuverability in an off-road use or when vehicle is unloaded.



WARNING

NEVER operate the vehicle with more pressure in the lift axles than is necessary to carry the load, as determined by the calibration procedure described. Failure to do so can result in loss of traction and stability at the steer and/or drive axles and can result in increased braking distance, which could cause loss of vehicle control resulting in an accident. Failure to comply may result in death, personal injury, equipment or property damage.



NOTE

Axle Creep ratings MUST NOT be exceeded.



CAUTION

Always lower the axles as soon as possible after receiving a load. Never exceed 5 mph (8 km/h) when driving with a load with the auxiliary axle(s) raised/unloaded. Failure to lower the

axle(s) can overload the frame and remaining axles, and could cause equipment damage.



CAUTION

DO NOT modify the air system and/or control functionality on a factory installed auxiliary axle(s). Modifying the factory operation of the pusher and/or tag axle(s) will void your warranty, and can cause equipment damage.



CAUTION

A change in tire size on either the auxiliary axles or the drive/steer axles can change the calibration of the auxiliary axles. If tires are installed with a different loaded radius, the calibration procedure must be repeated. Failure to do so can cause equipment damage.

Contact your dealer or axle manufacturer to determine what the creep rating is for your particular axle(s) and configuration. Creep ratings are generally limited to the following:

- Tandem rear axles only
- Straight trucks only
- Maximum spring mount centers per axle manufacturers specifications
- Maximum tire static loaded radius (SLR) per axle manufacturers specifications

Pusher or Tag Suspension Calibration

Perform this procedure at or near a weight scale. Procedure can be performed while parked on the weight scale if scale is available. To obtain the desired axle load distribution, you must correlate the suspension air gauge pressure to the actual axle load by scaling the axle weight(s) and adjusting the pressure to obtain the desired load. Once the desired load or load range is achieved, document the pressure-to-load ratio or setting for future use.



NOTE

This procedure must be performed prior to placing the vehicle into service.

Setting the Pressure-to-Load Ratio

To obtain the desired axle load distribution, you must correlate the suspension air gauge pressure to the actual axle load by scaling the axle weight(s) and adjusting the pressure to obtain the desired load. Once the desired load or load range is achieved, document the pressure-to-load ratio or setting for future use.

These instructions are general in nature. For more specific instructions, review the pusher or tag suspension manufacturer's maintenance manual or contact the nearest authorized dealer.

1. Park the loaded vehicle on a level surface with the wheels blocked.
2. Release vehicles spring brakes. (Do not release for Lifiable/Non-Steerable pusher or tag axles)
3. Lower the pusher/tag axles with the **Axle Lift Control** flip valve. (For some non-lifiable axles, inflate air suspension)
4. Adjust the amount of load on each axle by turning the **Pressure Regulator** clockwise to increase the load, or counterclockwise to decrease the load. (The suspension manufacturer may publish pre-established Pressure-to-Load Ratio Pressure Settings to

assist you in achieving an estimated ground load).

5. After setting the pressure to obtain the desired axle load, verify proper ground loading with the weight scale.

**NOTE**

Exceeding local, state, or federal weight limits may result in citations. Contact your local commercial weight enforcement office for limits in your area.

**NOTE**

Steerable-pusher and/or tag axle(s) will raise when the transmission is shifted into reverse or when the parking brake is applied.

What to do if an Air Spring Ruptures

If an air spring has ruptured, drive the vehicle to a safe stop off the highway to investigate the problem.

**WARNING**

DO NOT continue to drive with ruptured air springs. The air loss can cause the spring brakes to apply allowing your brakes to drag and burn up the linings, which could lead to an accident causing death or personal injury. DO NOT continue to operate the vehicle in this condition.

**WARNING**

DO NOT drive the vehicle if the air pressure is less than 100 psi (690 kPa). Driving the vehicle with less than 100 psi (690 kPa) could make the brakes unsafe to use which could cause an accident involving death or personal injury.



CAUTION

Operating a vehicle with air suspension bags either overinflated or underinflated may cause damage to drive-line components. If a vehicle must be operated under such conditions, do not exceed 5 mph (8 km/h). Failure to comply may result in equipment damage.

You can get to a repair facility by removing the height control link connected to the axle and to the suspension air valve control arm. This will cause the air valve control arm to center in the closed position. Removing the link will allow the air system of the vehicle to operate normally so that the vehicle can be driven to a service center.

Suspension Air Pressure Gauge & Switch

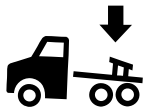

Your vehicle may have an air suspension and a deflation switch which allows the air in the suspension to be exhausted from a switch on the dash. The normal purpose of this feature is to lower the vehicle for loading. A guard on the switch prevents accidental deflation of the suspension. The Suspension Air Pressure gauge (optional) indicates the amount of air pressure in the air suspension springs in pounds per square inch (psi). Air pressure in the spring is related to the rear axle load. The greater the rear axle load, the greater the air pressure in the air bags. Therefore, the air pressure displayed will vary, depending upon the rear axle load.

Trailer Operations

How to Lock the Kingpin

Ensure that the fifth wheel lock is in the unlocked position.



WARNING

Always inspect the fifth wheel for proper locking after coupling the tractor to a trailer. Failure to properly couple the

tractor to a trailer (the kingpin is engaged in a closed lock jaw with the lock jaw secured by a closed plunger) may cause trailer separation which could result in an accident involving death or personal injury.

To lock the fifth wheel around the kingpin:

1. Ensure trailer brakes are locked and the landing gear is down.
2. Back the tractor fifth wheel into the trailer kingpin to engage and lock.

JOST Fifth Wheel Indication (Optional Indicator)



If equipped with JOST fifth wheel

3. Pull the tractor forward to ensure the kingpin has been locked in place.
4. Set the tractor parking brake.
5. Connect the tractor brake air and electric lines to the trailer.

Conduct a pre-trip inspection prior to releasing the brakes, raising the landing gear, and driving the vehicle.

Releasing the Kingpin Remotely (option)



CAUTION

Do not deflate the rear suspension before unlocking the fifth wheel. Deflating the rear suspension before unlocking the fifth wheel could cause difficulty during uncoupling and result in damage to the fifth wheel and kingpin.

1. Set both the vehicle and trailer parking brakes.
2. Lower the landing gear.
3. Disconnect the tractor brake air and electric lines from the trailer.
4. Flip up cover, then press and hold the **Kingpin Release** switch for 3 seconds. A countdown timer notification will appear on the display, and the unlock symbol on the **Kingpin Release** switch will illuminate.

The notification will inform the operator when to release the switch.

JOST Fifth Wheel Indication (option)



If equipped with JOST Fifth Wheel



NOTE

The fifth wheel will not unlock unless the vehicle is stopped and the parking brake is set. In this situation, a red-colored notification appears, informing the operator that kingpin release is not available and to set the parking brake. This will require restarting this procedure.

5. Release the switch.
The unlock symbol on the **Kingpin Release** switch will turn off.
6. Ease tractor forward enough for the kingpin to clear the fifth wheel (about 12 to 18 inches).



NOTE

Do not drive tractor free of trailer.

7. If the tractor has a rear air suspension, deflate (dump) the rear suspension enough so that the fifth wheel will smoothly separate from the trailer.

Suspension Dump Symbol



8. Ease tractor forward, clearing the trailer.
9. If the rear suspension was deflated, return rear suspension to its normal height.

Releasing the Kingpin Manually



CAUTION

Do not deflate the rear suspension before unlocking the fifth wheel. Deflating the rear suspension before unlocking the fifth wheel could cause difficulty during uncoupling and result in damage to the fifth wheel and kingpin.



NOTE

The specific method required to operate the fifth wheel release handle will depend on the fifth wheel manufacturer and model. The operator should be familiar with this method prior to attempting this procedure.

To release the kingpin and separate tractor from trailer

1. Position the tractor and trailer in a straight line on firm, level ground.
2. Set both the tractor and trailer parking brakes.
3. Exit cab and lower the trailer landing gear.

4. Disconnect brake air and electric lines from trailer, and secure lines.
5. Unlock the fifth wheel release handle if necessary, then unlock the fifth wheel.



NOTE

Operating the release handle and unlocking the fifth wheel will depend on the fifth wheel manufacturer.

6. Return to cab and release tractor parking brake.
7. Ease tractor forward enough for the kingpin to clear the fifth wheel (about 12 to 18 inches).



NOTE

Do not drive tractor free of trailer.

8. If the tractor has a rear air suspension, deflate (dump) the rear suspension enough so that the fifth wheel will smoothly separate from the trailer.

Suspension Dump Symbol



9. Ease tractor forward, clearing the trailer.
10. If the rear suspension was deflated, return rear suspension to its normal height.

Air-Controlled Sliding Fifth Wheel (option)



Vehicles that have an air-controlled sliding fifth wheel have a fifth wheel slider lock controlled by a switch on the accessory switch panel. To operate this type of lock, move the switch to the appropriate position. By placing the switch in the **UNLOCK** position, you can slide the fifth wheel to various positions to adjust weight distribution. There is a guard on this switch to protect you against accidentally activating or releasing the lock.

**WARNING**

DO NOT move the fifth wheel while the tractor-trailer is in motion. Your load could shift suddenly, causing you to lose control of the vehicle. Never operate the vehicle with the switch in the UNLOCK position. Always inspect the fifth wheel after you lock the switch to be sure the fifth wheel slide lock is engaged. Failure to comply may result in death, personal injury, equipment or property damage.

How to Slide the Fifth Wheel**WARNING**

DO NOT move the fifth wheel while the tractor-trailer is in motion. Your load could shift suddenly, causing you to lose control of the vehicle. Never operate the vehicle with the switch in the UNLOCK position. Always inspect the fifth wheel after you lock the switch to be sure the fifth wheel slide lock is engaged. Failure to comply may result

in death, personal injury, equipment or property damage.

**WARNING**

Do not attempt to slide the fifth wheel until all persons and obstacles are clear of the vehicle. Failure to comply may result in death, personal injury, equipment damage, or property damage.

**NOTE**

This procedure assumes a connected trailer. The trailer kingpin must be locked within the fifth wheel when changing slide positions.

1. Position the tractor and trailer in a straight line on firm, level ground.
2. Place the tractor in neutral, and set the tractor and trailer parking brakes.
3. Unlock the slide by repositioning the Fifth Wheel Slide switch.

**CAUTION**

Ensure the tractor and trailer brakes are engaged prior to sliding the fifth wheel. Failure to engage the brakes could result in uncontrolled sliding of the fifth wheel and possibly damage components on the tractor or trailer.

Fifth Wheel Slide Symbol

4. Inspect and verify that locking plungers have fully withdrawn from the fifth wheel slide tracks.
 - a. If locking plungers did not fully withdraw, move tractor slightly to reposition plungers and reinspect.
 - b. If plungers are still not fully withdrawn, lower the landing gear and deflate the rear

suspension (if available) to lessen pressure on the slide.

Suspension Dump Symbol

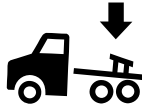

4

5. Release the tractor parking brake, but keep the trailer brake engaged.
6. Slowly ease tractor forward or backward, and stop at the desired position.
7. Lock the slide by returning the Fifth Wheel Slide switch to its previous position.
8. Inspect and verify that the locking plungers are fully inserted into the fifth wheel slide tracks.
 - a. If the locking plungers are not fully inserted in the track, move the tractor slightly to reposition plungers and reinspect.



WARNING

Do not operate the vehicle unless the locking plungers are fully inserted into the fifth wheel slide track. Operating the vehicle while the plungers are not fully inserted could lead to the slide moving unexpectedly, resulting in a loss of vehicle control and potentially causing property damage, serious injury, or death.

9. If the landing gear was lowered, raise the landing gear.
10. If the rear suspension was deflated, return rear suspension to its normal height.

Driving Tips and Techniques

This section covers additional driving tips and techniques on how to drive your vehicle more efficiently.

Coasting



WARNING

DO NOT coast with the transmission in neutral or with the clutch pedal depressed, it is a dangerous practice. Coasting in neutral may damage your drivetrain when you try to re-engage the transmission and could result in a loss of vehicle control. Failure to comply may result in death, personal injury, equipment damage, or property damage.

Do not coast with the transmission in neutral or with the clutch pedal depressed. Besides being illegal and dangerous, coasting is also expensive. It causes premature failure or damage to the clutch and transmission and overloads the brake system. Coasting with the transmission in neutral also prevents proper transmission component lubrication. During coasting the transmission is driven by the rear wheels, and the countershaft gear (which lubricates the transmission components by oil splash) will only be turning at idle speed.

Descending a Grade



WARNING

DO NOT hold the brake pedal down too long or too often while going down a steep or long grade. This could cause the brakes to overheat and reduce their effectiveness. As a result, the vehicle will not slow down at the usual rate. To reduce the risk of an accident which could cause personal injury or death, before going down a steep or long grade, reduce speed and shift the transmission into a lower gear to help control your vehicle speed. Failure to follow procedures for proper downhill operation could result in loss of vehicle control.

Engine Overspeed



CAUTION

Do not let the engine rpm operate beyond the maximum governing rpm. Operating the engine above the maximum governing rpm can result in engine damage.



NOTE

Often these recommendations are secondary to maintaining an adequate and safe speed relative to the surrounding traffic and road conditions.

Operate the engine within the optimum engine rpm range and do not allow the rpm to exceed the maximum governed speed. See your Engine Operation and Maintenance manual for information regarding engine rpm. When the engine is used as a brake to control vehicle speed (e.g., while driving down a grade), do not allow the engine rpm to exceed maximum governed speed. Under normal load and road conditions operate the engine in the lower end of the range.

The tachometer is an instrument that aids in obtaining the best performance of the engine and manual transmission, serving as a guide for shifting gears. Refer to the Engine Operation and Maintenance manual for optimum engine rpm.

- If the engine rpm moves beyond the maximum governed speed, indicating an overspeed condition, apply the service brake or shift to a

higher gear to bring engine rpm within the optimum speed range.

- When driving downhill: shift to a lower gear, use the engine brake (if so equipped), and use the service brake, keeping the engine speed below 2,100 rpm.

When the engine speed reaches its maximum governed speed, the injection pump governor cuts off fuel to the engine. However, the governor has no control over the engine rpm when it is being driven by the vehicle's transmission, for example, on steep downgrades. Apply service brakes or shift to a higher gear. Fuel economy and engine performance are also directly related to driving habits:

- The best results in trip time and fuel economy are obtained while driving the vehicle at a steady speed.
- Shift into higher or lower gears (or apply the service brake) to keep engine rpm near the lower end of the optimum operating range.
- Avoid rapid acceleration and braking.

Use of Digital Display



WARNING

DO NOT look at the Digital Display for prolonged periods while the vehicle is moving. The Digital Display should be referenced only briefly and should not be used as a substitute for observing actual road and traffic conditions. Failure to pay attention to the vehicle's road position or situation can lead to an accident. Failure to comply may result in death, personal injury, equipment damage, or property damage.

The Digital Display provides information to help the driver optimize vehicle efficiency. See [Optimal Engine Speed Indicator](#) on page 216 for more information. A driver will find the section describing Trip Information and the rpm detail useful.

Fuel Consumption

The vehicle's fuel consumption is connected to five important factors: maintenance, driving habits, general condition of the road, traffic conditions, and vehicle load.

Proper maintenance will keep the vehicle running like new even after long periods of use. The driver must perform the daily and weekly checks of the vehicle.

Maintenance factors affecting fuel consumption:

- Air and/or fuel filters partially clogged
- Engine valves out of adjustment
- Injection pump improperly synchronized
- Injection nozzles defective or uncalibrated
- Improperly inflated tires
- Wheel bearings improperly adjusted
- Clutch improperly adjusted or worn (slipping)
- Fuel leaks

Wrong driving habits must be corrected and the recommendations on economic driving should be followed. Driving factors affecting fuel consumption:

- Excessive speed and unnecessary fast acceleration
- Long periods of idling
- Driving with foot resting on the (manual transmission) clutch pedal

General Condition

Other factors affecting fuel consumption are related to loads and the type of roads on which the vehicle operates. It is not always possible to choose the most adequate road, but the ideal road is the one that allows a steady speed in high gear, without requiring frequent braking and acceleration. The following general conditions can affect fuel consumption:

- Overload
- Unbalanced load
- Very high load
- Inadequate roads
- Traffic conditions

Optimal Engine Speed Indicator

The tachometer displays a green bar just below the most efficient engine speed for the vehicle.

The placement and size of this bar is dependent on the engine as installed at the factory. The driver's general goal should be to select a gear that keeps the tachometer needle positioned over the green light as much as possible during steady state driving. In addition to proper maintenance and good driving habits, this visual cue can help minimize the fuel consumption.

What to Consider when using a Sleeper Bunk

If your vehicle has an upper and lower bunk, the upper bunk can be folded up out of the way to provide you with more dressing area in the sleeper cab. The lower bunk has storage underneath it to stow your luggage and other belongings. The upper bunk weight limit is 320 lb (145 kg).

 **WARNING**

Always keep the lower bunk in its down (latched) position while the vehicle is moving. If left open, stored items could become loose during an accident and strike you. Before you move the vehicle, check to be sure the lower bunk is latched securely. Failure to comply may result in death or personal injury.

 **WARNING**

Make sure the latch that holds the upper bunk in the folded position is working properly so the bunk will not fall open during vehicle operation. Pull on the bunk to make sure the bunk is latched securely. Failure to comply may result in death, personal injury, equipment or property damage.

 **WARNING**

Use the sleeper bunk restraint whenever the sleeper is occupied during vehicle operation. In an accident, an unrestrained person lying in a sleeper bunk could be seriously injured. He or she could be thrown from the bunk. Failure to comply may result in death, personal injury, equipment or property damage.

 **WARNING**

Be sure no one ever rides in the upper bunk. That person could be thrown out

in an accident and could be very seriously injured. DO NOT use the upper bunk while you are moving. Failure to comply may result in death, personal injury, equipment or property damage.

The sleeper restraint is stored in a compartment on the rear sleeper cab wall. [Sleeper Bunks and Restraints](#) on page 27, for more information on cab/seat restraint systems.

 **WARNING**

Failure to properly use the sleeper restraint when an individual is located in the sleeper bunk and the vehicle is moving can result in death or personal injury.

To Lower Upper Bunk Pull on the lanyard in the upper left corner of the bunk to release the bunk. This will free it from the anchored position and allow you to lower the bunk.

To Raise Upper Bunk Fold the upper bunk up and push it against the retaining latch until you hear a click. Pull on the bunk to be sure it is latched securely.

Stopping the Vehicle

A hot engine stores a great amount of heat. It does not cool down immediately after you shut it off. Always cool your engine down before shutting it off. You will greatly increase its service life.

Idle the engine at 1,000 rpm for five minutes. Then low idle for 30 seconds before shutdown. This will allow circulating coolant and lubricating oil to carry away heat from the cylinder head, valves, pistons, cylinder liners, turbocharger, and bearings. This way you can prevent serious engine damage that may result from uneven cooling.

Turbocharger

This cooling-down practice is especially important on a turbocharged engine. The turbocharger contains bearings and seals that are subjected to hot exhaust gases. While the engine is operating, heat is carried away by circulating oil. If you stop the engine suddenly, the temperature of the turbocharger could rise as much as 100°F (55°C) above the temperature reached during operation. A sudden rise in temperature like this could cause the bearings to seize or the oil seals to loosen.

Refueling

Air space in your fuel tanks allows water to condense there. To prevent this condensation while you are stopped, fill your tanks to 95 percent of capacity. When refueling, add approximately the same amount to each fuel tank on vehicles with more than one tank.



WARNING

DO NOT carry additional fuel containers in your vehicle. Fuel containers, either full or empty, may leak, explode, and cause or feed a fire. Failure to comply may result in death or personal injury.



WARNING

Diesel fuel in the presence of an ignition source could cause an explosion. A mixture of gasoline or alcohol with diesel fuel increases this risk of explosion. DO NOT remove a fuel tank cap near an open flame. Use only the fuel and/or additives recommended for your engine. Failure to comply may re-

sult in death, personal injury, equipment or property damage.



WARNING

Diesel or gasoline fuel in the presence of an ignition source could cause an explosion. A mixture of gasoline or alcohol with diesel fuel increases this risk of explosion. DO NOT remove a fuel tank cap near an open flame. Use only the fuel and/or additives recommended for your engine. Failure to comply may result in death, personal injury, equipment or property damage.



CAUTION

Use only Ultra Low Sulfur Diesel (ULSD) Fuel, as recommended by engine manufacturers. High-sulfur diesel fuel will damage the aftertreatment system and impact the engine emissions which will result in the engine not meeting emission regulations. Failure to comply may result in equipment or property damage.

**NOTE**

For more information on fuel specifications, consult the engine operator's manual.

If your vehicle is equipped with fuel shut off valves for the take-off and return lines, they are located on the fuel lines entering the top of the fuel tank. Fuel shut off valves for the fuel crossover line are on the bottom of the fuel tank, at the crossover line connection.

Final Stopping Procedures**WARNING**

When parking a vehicle, fully raise lift axles that are not equipped with a parking brake. If left in the down position, a lift axle not equipped with a parking brake could cause the parked vehicle to roll, resulting in an accident. Failure to comply may result in death, personal injury, equipment damage, or property damage.

Your vehicle will be easier to start driving when you are ready, and it will be safer for anyone who might be around it. Please remember, too, that in some states it is illegal to leave the engine running and the vehicle unattended.

1. Set the parking brake before leaving the driver's seat.

**WARNING**

DO NOT use the service brake or trailer hand brake to hold a parked vehicle. Because these brakes rely on air pressure, a loss of pressure could loosen the brakes and cause the vehicle to roll, resulting in an accident. Always set the parking brake. Failure to comply may result in property damage, personal injury, or death.

**WARNING**

DO NOT leave the transmission in gear to hold a parked vehicle. Always set the parking brake. Engine compression may not provide sufficient force to hold the vehicle, or the transmission may move out of gear, caus-

ing the vehicle to roll and result in an accident. Failure to comply may result in property damage, personal injury, or death.

2. If you are parked on a steep grade, block the wheels.

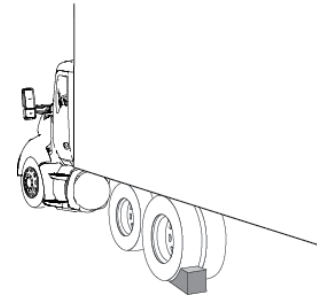

3. Drain water from the air reservoirs. Open the reservoir drains just enough to drain the moisture. Do not deplete the entire air supply. Be sure to close the drains before leaving the vehicle.

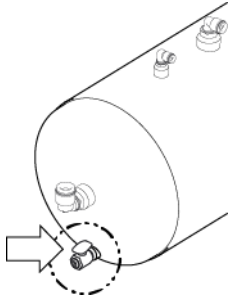

4

4. Secure the vehicle. Close all the windows and lock all the doors.

Chapter 5 | MAINTENANCE

New Vehicle Maintenance Schedule.....	225
First Day.....	225
First 50-100 mi / 80-160 km.....	225
First 500 mi / 800 km.....	225
First 2,000 mi / 3,218 km.....	226
First 3,000-5,000 mi / 4,800-8,000 km.....	226
Maintenance Schedule.....	227
At first 15,000 mi / 24,000 km or at first PM.....	229
Component Specific Intervals.....	233
Every 15,000 mi / 24,000 km / Monthly.....	236
Every 25,000 mi / 40,000 km / 6 Months.....	242
Every 30,000 mi / 48,000 km.....	242
Every 60,000 mi / 96,000 km / 6 Months.....	245
Every 120,000 mi / 192,000 km / Annually.....	254
Every 240,000 mi / 384,000 km.....	260
Every 300,000 mi / 480,000 km / 6,750 Hours / 3 Years.....	260

Every 500,000 mi / 800,000 km / 5 years.....	261
Every 750,000 mi / 1,200,000 km/ 24,000 Hours / 8 years.....	262
Air System.....	262
Axles and Suspensions.....	269
Brake System.....	277
Cab Maintenance.....	280
Clutch.....	285
Cooling System Maintenance.....	286
Driveline.....	292
Driver Assistance Maintenance.....	293
Electrical System.....	294
Engine Maintenance.....	302
Frame.....	311
Fuel System.....	312
Heater and Air Conditioner Maintenance.....	313
Lighting.....	315
Lubricants.....	318
Noise and Emission Control.....	320
Seating and Restraints.....	324

Steering System.....	326
Tires.....	329
Transmission Maintenance.....	332
Wheels.....	332
Windshield Wiper/Washer.....	335
Specification Reference Charts.....	335
Over-the-Air (OTA) Software Updates.....	344

New Vehicle Maintenance Schedule First Day

First Day
Perform a total vehicle alignment once a body is installed on the truck chassis.
Steering U-joint Pinch Bolt <ul style="list-style-type: none"> Refer to Steering Shaft Bolt Torque Specifications on page 328 for maintenance instructions.
Front Suspension - U-bolts <ul style="list-style-type: none"> Check the general condition and the tightness of the nuts. Tighten the U-bolts using a calibrated torque wrench to the specified torque value. (Refer to Suspension U-Bolts, Class 10.9 on page 339 for maintenance instructions.)

5

First 50-100 mi / 80-160 km

First 50-100 mi / 80-160 km¹¹
Wheel Mounting <ul style="list-style-type: none"> Refer to Wheels on page 332 for maintenance instructions.

First 500 mi / 800 km

¹¹ Ensure that all maintenance intervals leading up to this point are repeated during this interval prior to the completion of those listed here.

First 500 mi / 800 km¹²

Front Axle U-Bolt Torque

- Refer to [Suspension U-Bolts, Class 10.9](#) on page 339 for maintenance instructions.

Charge Air Cooler and Air Intake Pipe Clamps

- Retorque fasteners. Refer to [Pipe and Hose Clamp Torque Values](#) on page 305 for maintenance instructions.

First 2,000 mi / 3,218 km

First 2,000 mi / 3,218 km¹³

Rear Suspension Fasteners

- Refer to [Rear Axle and Suspension](#) on page 272 for maintenance instructions.

First 3,000-5,000 mi / 4,800-8,000 km

¹² Ensure that all maintenance intervals leading up to this point are repeated during this interval prior to the completion of those listed here.

¹³ Ensure that all maintenance intervals leading up to this point are repeated during this interval prior to the completion of those listed here.

First 3,000-5,000 mi / 4,800-8,000 km ¹⁴
Transmission Lubrication <ul style="list-style-type: none"> Refer to Transmission Operator's Manual for maintenance instructions.
Axle Lubrication. <ul style="list-style-type: none"> For Meritor axle, refer to Meritor Axle Lubrication on page 275 for maintenance instructions. For Eaton/Dana axle, refer to Eaton/Dana Axle Lubrication on page 274 for maintenance instructions.

Maintenance Schedule

Preventive maintenance program begins with the daily and weekly routine checks [Daily Checks](#) on page 35. Routine vehicle checks can help avoid many large, expensive, and time consuming repairs. The vehicle will operate better, be safer, and last longer. Neglect of recommended maintenance can void your vehicle's warranty. Some maintenance operations demand skills and equipment you may not have. For such situations, please take your vehicle to an authorized Service Center.

 **WARNING**

Before attempting any procedure in the engine compartment, stop the engine and let it cool down. Hot fluids and components can burn skin on contact. Failure to comply may result in death, personal injury, equipment damage, or property damage.

 **WARNING**

If the engine must be running to inspect, be alert and cautious around the engine at all times. Failure to com-

ply may result in death, personal injury, equipment or property damage.

 **WARNING**

If work must be done with the engine running, always:

- Ensure that the transmission is in neutral (**N**) or park (**P**)
- Set the parking brake
- Block the wheels

Failure to comply may result in death, personal injury, equipment or property damage.

¹⁴ **Ensure that all maintenance intervals leading up to this point are repeated during this interval prior to the completion of those listed here.**



WARNING

DO NOT wear neckties, jewelry, and/or loose clothing, and secure long hair to avoid getting caught in the fan blades or other moving engine parts. Failure to comply may result in death, personal injury, equipment damage, or property damage.



WARNING

Always support the vehicle with appropriate safety stands if it is necessary to work underneath the vehicle. A jack is not adequate for this purpose. Failure to comply may result in death, personal injury, equipment or property damage.



WARNING

When working underneath the vehicle with the wheels on the ground (not supported), make sure that

- The vehicle is on hard, level ground.

- The parking brake is applied.
- All wheels are blocked (front and rear).
- The ignition key is removed to prevent the engine from starting.

Failure to comply may result in death, personal injury, equipment damage or property damage.



WARNING

NEVER start or let the engine run in an enclosed, unventilated area. Engine exhaust fumes contain carbon monoxide, a colorless and odorless gas. Carbon monoxide can be fatal if inhaled. Failure to comply may result in death, personal injury, equipment damage, or property damage.



WARNING

Disconnect the battery ground cable whenever you work on the fuel system or the electrical system. When you work around fuel, do not smoke or work near heaters or other fire haz-

ards. Keep an approved fire extinguisher near to you. Failure to comply may result in death, personal injury, equipment or property damage.

The following pages contain a table of maintenance tasks with the related intervals for each task on the right side of the table. The top of the table displays a guide to a maintenance interval and its schedule. Some tasks are dependent on the vehicle application. These tasks will be shown as separate tasks and will have the words “ON HIGHWAY”, “CITY DELIVERY” or “OFF-HIGHWAY” after the description. These tasks are differentiated because they are dependent on the vehicle’s operating environment. On highway is defined for applications where the vehicle is NOT used off of a paved road during normal operation. City Delivery is defined for applications where frequent start and stopping is required during normal operation and the highway is used infrequently and for short periods of time. Off highway is defined for applications where the vehicle may be driven off the pavement on a regular basis, even if it is an infrequent basis and/or for a brief time period. Please contact an authorized service dealership if there are questions

regarding which interval to follow. Consult the supplier for specific recommendations where discrepancies develop between these recommendations in this table and component supplier recommendations.

- Engine lubricating oil change intervals are not listed here. Refer to your engine's operating manual for recommendations. For specific information on maintenance procedures consult your vehicle maintenance manual.

- The initial fill of drive axle lubricant must be changed before the end of the first scheduled maintenance interval. See the axle manufacturer's operator's manual for recommended lubrication specifications and service intervals.
- The initial fill of lubricant in manual transmissions must be changed before the end of the first maintenance interval. See the transmission manufacturer's

operator's manual for recommended lubrication specifications and service intervals.

- If your vehicle is equipped with an automatic transmission, consult the owner's manual for it that came with your vehicle to obtain lubricant check and change intervals.

At first 15,000 mi / 24,000 km or at first PM

At first 15,000 mi / 24,000 km or at first PM¹⁵

Front Suspension U-bolts

- (ON HIGHWAY) Check the general condition and the tightness of the nuts. Tighten the nuts to the specified torque value as required; (Refer to [Suspension U-Bolts, Class 10.9](#) on page 339 for maintenance instructions.)
- (VOCATIONAL) Check the general condition and the tightness of the nuts. Tighten the U- bolts after the first day or two of operation. Then tighten the nuts to the specified torque value as required; (Refer to [Suspension U-Bolts, Class 10.9](#) on page 339 for maintenance instructions.)

Drive Axle (SISU) - Axle Housing

- [Drive Axle \(SISU\) Oil Servicing](#) on page 277
- [Drive Axle \(SISU\) Inspection](#) on page 277

¹⁵ Ensure that all maintenance intervals leading up to this point are repeated during this interval prior to the completion of those listed here.

At first 15,000 mi / 24,000 km or at first PM ¹⁵
<p>Rear Suspension - U-bolts</p> <ul style="list-style-type: none"> • Check the torque. Tighten to specified torque value as required. (Refer to Suspension U-Bolts, Class 10.9 on page 339 for maintenance instructions.)
<p>Rear Suspension - Mounting Brackets and Fasteners</p> <ul style="list-style-type: none"> • Check the condition and the fastener torque. Tighten to the specified torque value as required; (Refer to Rear Axle and Suspension on page 272 for maintenance instructions.)
<p>Main and Auxiliary Transmission - Main and Auxiliary Transmission and Transfer Case</p> <ul style="list-style-type: none"> • Inspect for visible damage, signs of overheating, and leaks. (Refer to Transmission Maintenance on page 332 for maintenance instructions.)
<p>Main and Auxiliary Transmission - Main and Auxiliary Transmission (OFF HIGHWAY)</p> <ul style="list-style-type: none"> • Drain lubricant while warm. Flush each unit with clean flushing oil. (Refer to Transmission Maintenance on page 332 for maintenance instructions.)
<p>Auxiliary Transmission - Cotta Transfer Case TR2205 Fabco Transfer Case TC142/TC143/ TC170/ TC270 Marmon-Harrington Transfer Case MVG2000/ MVG2000SD</p> <ul style="list-style-type: none"> • Initial oil change: Drain oil while warm: flush case with gear oil-compatible fluid, clean magnetic drain plug, and refill. Do not flush the case with any solvent.
<p>Cooling - Hoses</p> <ul style="list-style-type: none"> • Check the radiator and heater hoses for leaks. (Refer to Cooling System Maintenance on page 286 for maintenance instructions.)

¹⁵ Ensure that all maintenance intervals leading up to this point are repeated during this interval prior to the completion of those listed here.

At first 15,000 mi / 24,000 km or at first PM ¹⁵
<p>Cooling - Fan Clutch</p> <ul style="list-style-type: none"> • Check for air leaks. Check the fan drive bearings (turn the sheave in both directions to check for worn hub bearings.)(Refer to Engine Fan on page 306 for maintenance instructions.)
<p>Cooling - Solenoid Valve</p> <ul style="list-style-type: none"> • Check the fan drive for proper engagement and disengagement. (Refer to Engine Fan on page 306 for maintenance instructions.)
<p>Power Steering - Reservoir (ON HIGHWAY)</p> <ul style="list-style-type: none"> • Drain, replace the filter, and refill; (Refer to Check Power Steering Fluid Level on page 327 for maintenance instructions.)
<p>Power Steering - Reservoir (OFF HIGHWAY)</p> <ul style="list-style-type: none"> • Drain, replace the filter, and refill. (Refer to Check Power Steering Fluid Level on page 327 for maintenance instructions.)
<p>Steering Components - Drag link Castle Nut and Ball Stud</p> <ul style="list-style-type: none"> • Check the torque: tighten to specified torque value as required. (Refer to Steering System on page 326 for maintenance instructions.)
<p>Steering Components - Pitman Arm Clamp Bolt and Nut</p> <ul style="list-style-type: none"> • Check the torque: tighten to specified torque value as required. (Refer to Steering System on page 326 for maintenance instructions.)
<p>Steering Components - Steering Intermediate Shaft</p> <ul style="list-style-type: none"> • Check the torque on the pinch bolt and nut. (Refer to Steering Shaft Bolt Torque Specifications on page 328 for maintenance instructions.)

¹⁵ Ensure that all maintenance intervals leading up to this point are repeated during this interval prior to the completion of those listed here.

At first 15,000 mi / 24,000 km or at first PM ¹⁵
<p>Steering Components - Steering Intermediate Shaft U-joints (ON HIGHWAY)</p> <ul style="list-style-type: none"> Lubricate [Chevron Delo EP NLGI-2 grease or equivalent]. (Refer to Steering System on page 326 for maintenance instructions.)
<p>Steering Components - Steering Intermediate Shaft U-joints (OFF HIGHWAY or CITY DELIVERY)</p> <ul style="list-style-type: none"> Lubricate [Chevron Delo EP NLGI-2 grease or equivalent]. (Refer to Steering System on page 326 for maintenance instructions.)
<p>Steering Components - Drag link and Tie Rod Arm Ball Sockets (ON HIGHWAY, OFF HIGHWAY or CITY DELIVERY)</p> <ul style="list-style-type: none"> Lubricate (Chevron Delo EP NLGI-2 grease or equivalent.) (Refer to Steering System on page 326 for maintenance instructions.)
<p>Fuel and Tanks - Fuel Tank Straps</p> <ul style="list-style-type: none"> Check the strap tightness: tighten to proper torque value as required; aluminum tank - 30 lb-ft (41 N·m) cylindrical steel tank - 8 lb-ft (11 N·m.) (Refer to Fuel Tank on page 313 for maintenance instructions.)
<p>Driveshafts - Models SPL-90, 1710 and 1810 Slip Member and U-joints</p> <ul style="list-style-type: none"> Lubricate*
<p>Driveshafts - Models SPL- 140/140HD/170/170HD/250/250HD Slip Members and U- joints (OFF HIGHWAY)</p> <ul style="list-style-type: none"> Lubricate*

¹⁵ Ensure that all maintenance intervals leading up to this point are repeated during this interval prior to the completion of those listed here.

At first 15,000 mi / 24,000 km or at first PM¹⁵

Electrical and Lights - Fuel and Diesel Exhaust Fluid Tank Sending Unit

- Check the mounting screws and electrical connections for worn or damaged wires and connectors.

Component Specific Intervals

These maintenance tasks should be reviewed at each maintenance interval. They are not specific to one interval.

Component Specific Intervals¹⁶

Drive Axle (Dana) - Axle Housing *Drive Axle - Dana* on page 274

Drive Axle (Meritor Line Haul / ON HIGHWAY) *Drive Axle - Meritor* on page 275

Drive Axle (Meritor City Delivery / OFF HIGHWAY) *Drive Axle - Meritor* on page 275

¹⁵ **Ensure that all maintenance intervals leading up to this point are repeated during this interval prior to the completion of those listed here.**

* Use only Spicer Driveshaft approved lubricants when greasing Spicer U-joints.

¹⁶ **Ensure that all maintenance intervals leading up to this point are repeated during this interval prior to the completion of those listed here.**

Component Specific Intervals ¹⁶
<p>Front Axle - Vocational (PACCAR) - Kingpin Bushings, Thrust Bearings, and Tie Rod Ball Ends (OFF-HIGHWAY)</p> <ul style="list-style-type: none"> Lubricate with approved grease. Weekly regardless of mileage. (Refer to Front Axle and Suspension on page 269 for maintenance instructions.)
<p>Front Axle - Vocational (PACCAR) - Steering Knuckle Spindles, Thrust Bearings, Kingpins, Drawkeys, Tie Rod Ends, Steering Stops, and Bushings (OFF-HIGHWAY)</p> <ul style="list-style-type: none"> Inspect for wear and damage and for endplay. Shim or replace as required. Weekly regardless of mileage. (Refer to Front Axle and Suspension on page 269 for maintenance instructions.)
<p>PACCAR TX-12/TX-18 or Eaton Endurant Transmission (Only) - Lubrication (OFF-HIGHWAY)</p> <ul style="list-style-type: none"> Perform maintenance on the air dryer - (Refer to Air Dryer Maintenance on page 267 for maintenance instructions.) Drain lubricant while warm. Flush each unit with clean flushing oil. (Refer to Transmission Maintenance on page 332 for maintenance instructions.)
<p>Air Intake - Air filter</p> <ul style="list-style-type: none"> Replace the engine intake air filter element. Every 12 months or when required by air restriction indicator or required by the engine manufacturers operator manual. (Refer to Air Intake System on page 307 for maintenance instructions.)
<p>Clutch - Clutch Hydraulic Fluid</p> <ul style="list-style-type: none"> Replace fluid and bleed system. 240,000 mi (384,000 km) or 2 years, whichever occurs first. (Refer to Hydraulic Clutch on page 285 for maintenance instructions.)
<p>Tires and Wheels - Tires</p> <ul style="list-style-type: none"> Check inflation pressure. Weekly "cold" using calibrated gauge. (Refer to Tires on page 329 for maintenance instructions.)

¹⁶ Ensure that all maintenance intervals leading up to this point are repeated during this interval prior to the completion of those listed here.

Component Specific Intervals ¹⁶
Driveshafts - Models SPL-90, 1710 and 1810 slip member and U-joints <ul style="list-style-type: none"> Inspect. U-joint inspections should be performed every time a vehicle comes in for scheduled maintenance.
Driveshafts - Models SPL-100 slip member and U-joints <ul style="list-style-type: none"> Inspect. U-joint inspections should be performed every time a vehicle comes in for scheduled maintenance.
Driveshafts - Models SPL-140/140HD/170/170HD/250/250HD slip members and U-joints (ON HIGHWAY and LINEHAUL) <ul style="list-style-type: none"> Inspect. U-joint inspections should be performed every time a vehicle comes in for scheduled maintenance.
Driveshafts - Models SPL-140XL/170XL/250XL slip members and U-joints (OFF HIGHWAY) <ul style="list-style-type: none"> Lubricate. 350,000 mi (560,000 km) 1st interval and then every 100,000 mi (160,00 km) after that.
Driveshafts - Models SPL-140XL/170XL/250XL slip members and U-joints (ON HIGHWAY and LINE HAUL) <ul style="list-style-type: none"> Inspect. U-joint inspections should be performed every time a vehicle comes in for scheduled maintenance.
Driveshafts - Models SPL-140XL/170XL/ 250XL slip members and U-joints (OFF HIGHWAY and CITY) <ul style="list-style-type: none"> Inspect. U-joint inspections should be performed every time a vehicle comes in for scheduled maintenance.
Aftertreatment System - Diesel particulate filter <ul style="list-style-type: none"> Clean filter. Refer to the <i>Engine Maintenance Manual</i>.
Aftertreatment System - Diesel exhaust fluid supply module <ul style="list-style-type: none"> Replace filter. Refer to the <i>Engine Maintenance Manual</i>.

¹⁶ **Ensure that all maintenance intervals leading up to this point are repeated during this interval prior to the completion of those listed here.**

* Use only Spicer Driveshaft approved lubricants when greasing Spicer U-joints.

Component Specific Intervals ¹⁶
<p>Air - Air dryer (ON HIGHWAY)</p> <ul style="list-style-type: none"> • 360,000 miles/576,000 km (Refer to Air Dryer Maintenance on page 267 for maintenance instructions.)
<p>Engine - Basic Engine Maintenance and service interval recommendations are detailed in the engine manufacturer's Operations and Maintenance Manual included with the vehicle. The engine manufacturer's recommendations vary depending engine model. Information is also available from authorized dealers, the engine manufacturer's authorized service centers, and the engine manufacturer's web site.</p>
<p>Safety - Three-point Seat Belt System</p> <ul style="list-style-type: none"> • Inspect. 20,000 miles/32,000km If the vehicle is exposed to severe environmental or working conditions, more frequent inspections may be necessary. (Refer to Safety Restraint System - Inspection on page 324 for maintenance instructions.)

Every 15,000 mi / 24,000 km / Monthly

Every 15,000 mi / 24,000 km / Monthly ¹⁷
<p>Frame - Fifth Wheel</p> <ul style="list-style-type: none"> • Check the kingpin lock and plate for wear and function: lubricate (NLGI #2 grease.) (Refer to Fifth Wheel Monthly Maintenance on page 312 for maintenance instructions.)

¹⁶ Ensure that all maintenance intervals leading up to this point are repeated during this interval prior to the completion of those listed here.

¹⁷ Ensure that all maintenance intervals leading up to this point are repeated during this interval prior to the completion of those listed here.

Every 15,000 mi / 24,000 km / Monthly ¹⁷
<p>Front Suspension - Spring Pins</p> <ul style="list-style-type: none"> • Check for proper function. (Refer to Front Axle and Suspension on page 269 for maintenance instructions.)
<p>Front Suspension - U-bolts (OFF HIGHWAY)</p> <ul style="list-style-type: none"> • Check the general condition and the tightness of the nuts. Tighten the U- bolts after the first day or two of operation. Then tighten the nuts to the specified torque value as required. (Refer to Suspension U-Bolts, Class 10.9 on page 339 for maintenance instructions.)
<p>Drive Axle - Vocational (PACCAR) - Axle Assembly</p> <ul style="list-style-type: none"> • Check oil level • Visually inspect for damage or leaks.
<p>Drive Axle - Vocational (PACCAR) - Breather</p> <ul style="list-style-type: none"> • Check the operation. If the cap doesn't rotate freely, replace.
<p>Drive Axle (Meritor City Delivery / OFF HIGHWAY) - Axle Housing</p> <ul style="list-style-type: none"> • Check the "cold" fill level at the differential carrier plug for a pinion angle of less than 7 degrees, or at the axle bowl plug for a pinion angle of greater than 7 degrees. Tighten the plug to 35-50 lb-ft (47-68 N·m.) (Refer to Drive Axle - Meritor on page 275 for maintenance instructions.) • Visually inspect for damage or leaks. (Refer to Drive Axle - Meritor on page 275 for maintenance instructions.)
<p>Drive Axle (Meritor City Delivery / OFF HIGHWAY) - Breather</p> <ul style="list-style-type: none"> • Check the operation. If the cap doesn't rotate freely, replace. (Refer to Drive Axle - Meritor on page 275 for maintenance instructions.)

¹⁷ **Ensure that all maintenance intervals leading up to this point are repeated during this interval prior to the completion of those listed here.**

Every 15,000 mi / 24,000 km / Monthly ¹⁷
<p>Drum Brakes (All) - Slack Adjusters</p> <ul style="list-style-type: none"> • Check the push rod travel and check the control arm for cracks. Adjust at reline. (Refer to Auto Slack Adjuster on page 279 for maintenance instructions.) • Lubricate (NLGI #2 grease.)
<p>Drum Brakes (All) - Brake Air System</p> <ul style="list-style-type: none"> • Check air lines and fittings for leaks. Adjust routing as required to prevent chafing. Check tank mounting and condition. (Refer to How to Check the Compressed Air System for Leaks on page 265 for maintenance instructions.)
<p>Hub, Drum, and Hubcap - Hubcaps</p> <ul style="list-style-type: none"> • Clean the sight window. Check the center plug, mounting flange, and fill plug for leaks and for proper installation. Replace broken or damaged parts. Check the lubricant level and add as required. (Refer to Wheels on page 332 for maintenance instructions.)
<p>Main and auxiliary Transmission - General (ON-HIGHWAY and CITY DELIVERY)</p> <ul style="list-style-type: none"> • Inspect exterior for leaks. • Check the oil level: refill as required (See for maintenance instructions). • Inspect exterior seals for damage, and replace as necessary.
<p>Auxiliary Transmission - Cotta Transfer Case TR2205 Fabco Transfer Case TC142/TC143/ TC170/ TC270</p> <ul style="list-style-type: none"> • Inspect: Check oil level, inspect for leaks and any visible damage.
<p>Marmon-Harrington Transfer Case MVG2000/ MVG2000SD</p> <ul style="list-style-type: none"> • Replace/clean the air filter pre-cleaner, if equipped.

¹⁷ Ensure that all maintenance intervals leading up to this point are repeated during this interval prior to the completion of those listed here.

Every 15,000 mi / 24,000 km / Monthly ¹⁷
<p>Air Intake - Pre-Cleaner</p> <ul style="list-style-type: none"> Inspect for cuts, irregular wear, missing lugs, sidewall damage, etc. (Refer to Air Intake System on page 307 for maintenance instructions.)
<p>Tires and Wheels - Tires</p> <ul style="list-style-type: none"> Inspect the wheel disc for any cracks or surface irregularities. Inspect the rim edge and bead seat area for damage. Replace any damaged wheels - DO NOT ATTEMPT TO REPAIR. (Refer to Tires on page 329 for maintenance instructions.)
<p>Tires and Wheels - Disc Wheels</p> <ul style="list-style-type: none"> Inspect the mounting ring, rim gutter, side ring, and lock ring for damage: replace as required. (Refer to Wheels on page 332 for maintenance instructions.)
<p>Tires and Wheels - Demountable Rims</p> <ul style="list-style-type: none"> Check the tightness of the fasteners and tighten the fasteners to the specified torque as required. (Refer to Wheels on page 332 for maintenance instructions.)
<p>Tires and Wheels - Wheel Nuts and Studs</p> <ul style="list-style-type: none"> Inspect for damaged hex corners, stripped or damaged threads, and excessive corrosion: clean or replace as required. (Refer to Wheels on page 332 for maintenance instructions.)
<p>Power Steering - Reservoir</p> <ul style="list-style-type: none"> Check the fluid level. (Refer to Check Power Steering Fluid Level on page 327 for maintenance instructions.)
<p>Power Steering - Power Assist Cylinder</p> <ul style="list-style-type: none"> Lubricate (Chevron Delo EP NLGI-2 grease or equivalent.) (Refer to Steering System on page 326 for maintenance instructions.)

¹⁷ Ensure that all maintenance intervals leading up to this point are repeated during this interval prior to the completion of those listed here.

Every 15,000 mi / 24,000 km / Monthly ¹⁷
<p>Steering Components - Drag link and Tie Rod Arm Ball Sockets (OFF HIGHWAY or CITY DELIVERY)</p> <ul style="list-style-type: none"> Lubricate (Chevron Delo EP NLGI-2 grease or equivalent). (Refer to Steering System on page 326 for maintenance instructions.)
<p>Fuel and Tanks - Fuel Tank Steps</p> <ul style="list-style-type: none"> Check for snug fit of side plates against tank and tank straps. Check for damaged or broken steps, missing bolts, and missing grommet between tank and side plate. Replace missing or damaged parts and adjust for fit as required. (Refer to Fuel Tank on page 313 for maintenance instructions.)
<p>Driveshafts - Models SPL-90, 1710 and 1810 Slip Member and U-joints</p> <ul style="list-style-type: none"> Lubricate
<p>Driveshafts - Model SPL-100 Slip Member and U-joints</p> <ul style="list-style-type: none"> Check the condition of the cables, cushion clamps, nylon tie straps, and routing. Replace a cushion clamp if the rubber has deteriorated. Repair or tighten terminals, and secure cables to prevent chafing. Replace damaged cables (cuts, cracks, or excessive wear.) (Refer to Batteries on page 296 for maintenance instructions.)
<p>Battery Boxes, Tool Boxes, and Steps - Battery Cables Battery Boxes, Tool Boxes, and Steps - Batteries (OFF-HIGHWAY)</p> <ul style="list-style-type: none"> Check for cracks and damage, electrolyte level, condition of terminals, and tightness of hold downs. (Refer to Batteries on page 296 for maintenance instructions.)
<p>Battery Boxes, Tool Boxes, and Steps - Battery Box and Tray (OFF-HIGHWAY)</p> <ul style="list-style-type: none"> Check the box integrity. Clean the drain tube and check for acid leaks. Check condition of all equipment mounted under the box. (Refer to Batteries on page 296 for maintenance instructions.)

¹⁷ **Ensure that all maintenance intervals leading up to this point are repeated during this interval prior to the completion of those listed here.**

* Use only Spicer Driveshaft approved lubricants when greasing Spicer U-joints.

Every 15,000 mi / 24,000 km / Monthly ¹⁷
<p>Battery Boxes, Tool Boxes, and Steps - Battery Cable Fasteners</p> <ul style="list-style-type: none"> • Check battery cable fasteners and tighten as necessary to 10-15 lb-ft (13.6-20.3 N·m) as specified on the battery label. (Refer to Batteries on page 296 for maintenance instructions.)
<p>Electrical and Lights - Warning Lights in Light Bar</p> <ul style="list-style-type: none"> • Check at the ignition start position to verify bulb check and systems check function. (Refer to Bulb Check on page 77 for maintenance instructions.)
<p>Electrical and Lights - Turn, Stop, Reverse Lights and Signals</p> <ul style="list-style-type: none"> • Visual check. (Refer to Daily Checks on page 35).
<p>Electrical and Lights - Power Supply Harnesses (engine, Transmission, etc.)</p> <ul style="list-style-type: none"> • Check for worn or damaged insulation, corroded terminals, frayed wires, and oil or fluid leaks on the connectors or wiring. (Refer to Electrical System on page 294 for maintenance instructions.)
<p>Heating and Air Conditioning - Air Conditioner</p> <ul style="list-style-type: none"> • Operate the system. (Refer to Heater and Air Conditioner Maintenance on page 313 for maintenance instructions.)
<p>Heating and Air Conditioning - Cabin Fresh Air Filter (ON HIGHWAY)</p> <ul style="list-style-type: none"> • Inspect and clean, replace if necessary. (Refer to How to Replace Air Conditioner Filter on page 315 for maintenance instructions.)
<p>Heating and Air Conditioning - Cabin Fresh Air Filter (OFF-HIGHWAY)</p> <ul style="list-style-type: none"> • Inspect and clean, replace if necessary. (Refer to How to Replace Air Conditioner Filter on page 315 for maintenance instructions.)

¹⁷ Ensure that all maintenance intervals leading up to this point are repeated during this interval prior to the completion of those listed here.

Every 15,000 mi / 24,000 km / Monthly¹⁷

Aftertreatment System - System

- Check for leaks and proper support. (Refer to [Noise and Emission Control](#) on page 320 for maintenance instructions.)

Every 25,000 mi / 40,000 km / 6 Months

Every 25,000 mi / 40,000 km / 6 Months

Front Axle - Linehaul (PACCAR) - Kingpin Joint Grease/Tie Rod Ends

- Heavy-Duty Multipurpose Lithium Based: #1 or #2 Grade. (Refer to [Front Axle and Suspension](#) on page 269 for maintenance instructions.)

Every 30,000 mi / 48,000 km

Every 30,000 mi / 48,000 km¹⁸

Front Suspension - Spring Pins

- Lubricate with approved grease. (Refer to [Front Axle and Suspension](#) on page 269 for maintenance instructions.)

¹⁷ Ensure that all maintenance intervals leading up to this point are repeated during this interval prior to the completion of those listed here.

¹⁸ Ensure that all maintenance intervals leading up to this point are repeated during this interval prior to the completion of those listed here.

Every 30,000 mi / 48,000 km ¹⁸
<p>Drive Axle - Linehaul (PACCAR) - Axle Assembly</p> <ul style="list-style-type: none"> • Check oil level and inspect for leaks. • Visually inspect for damage or leaks.
<p>Drive Axle - Linehaul (PACCAR) - Breather</p> <ul style="list-style-type: none"> • Check the operation. If the cap doesn't rotate freely, replace.
<p>Drive Axle - Vocational (PACCAR) - Axle Assembly</p> <ul style="list-style-type: none"> • Drain and replace MINERAL BASE lubricant. Drive Axle (Meritor Line Haul / ON HIGHWAY) - Axle Housing • Check the "cold" fill level at the differential carrier plug for a pinion angle of less than 7 degrees, or at the axle bowl plug for a pinion angle of greater than 7 degrees. Tighten the plug to 35-50 lb-ft (47-68 N·m.) (Refer to Drive Axle - Meritor on page 275 for maintenance instructions.) • Visually inspect for damage or leaks. (Refer to Drive Axle - Meritor on page 275 for maintenance instructions.)
<p>Drive Axle (Meritor Line Haul / ON HIGHWAY) - Breather</p> <ul style="list-style-type: none"> • Check the operation. If the cap doesn't rotate freely, replace. (Refer to Drive Axle - Meritor on page 275 for maintenance instructions.)
<p>Drum Brakes (All) - Brake Treadle Valve</p> <ul style="list-style-type: none"> • Clean the area around the treadle, boot, and mounting plate. Check the pivot and mounting plate for integrity. Check the plunger boot for cracks. Lubricate roller pin, pivot pin, and plunger (NLGI #2 grease.) (Refer to Drum Brake Inspection on page 279 for maintenance instructions.)
<p>Drum Brakes (All) - Brake Lining</p> <ul style="list-style-type: none"> • Inspect: replace as required. (Refer to Drum Brake Inspection on page 279 for maintenance instructions.)

¹⁸ **Ensure that all maintenance intervals leading up to this point are repeated during this interval prior to the completion of those listed here.**

Every 30,000 mi / 48,000 km ¹⁸
<p>Hub, Drum, and Hubcap - Hubs (non-LMS)</p> <ul style="list-style-type: none"> • Check the bearing endplay and adjust as required. (Refer to Wheels on page 332 for maintenance instructions.)
<p>Hub, Drum, and Hubcap - Hub Seals (all)</p> <ul style="list-style-type: none"> • Check for leaks: replace as required. (Refer to Wheels on page 332 for maintenance instructions.)
<p>Hub, Drum, and Hubcap - Brake Drums</p> <ul style="list-style-type: none"> • Inspect for visible cracks, heat checking, galling or scoring of the braking surface, and for severe corrosion on the outside surface. Check for out-of-round or oversize condition [0.080 in. (2 mm) more than the original diameter]. Replace as required. (Refer to Brake System on page 277 for maintenance instructions.)
<p>Main and Auxiliary Transmission (including PACCAR TX-12/TX-18 or Eaton Endurant Transmission) - Main and Auxiliary Transmission</p> <ul style="list-style-type: none"> • Check the oil level: refill as required. (Refer to Transmission Maintenance on page 332 for maintenance instructions.)
<p>Main and Auxiliary Transmission (including PACCAR TX-12/TX-18 or Eaton Endurant Transmission) - Main and Auxiliary Transmission and Transfer Case</p> <ul style="list-style-type: none"> • Check the drain plugs for tightness. (Refer to Transmission Maintenance on page 332 for maintenance instructions.)
<p>Clutch - Clutch Release Bearing</p> <ul style="list-style-type: none"> • Lubricate. (Refer to Hydraulic Clutch on page 285 for maintenance instructions.) • Inspect and adjust when necessary (no adjustment required for SOLO type clutches.) (Refer to Hydraulic Clutch on page 285 for maintenance instructions.)
<p>Cooling - Extended Life Coolant (ELC)</p> <ul style="list-style-type: none"> • Check coolant/antifreeze condition. (Refer to Cooling System Maintenance on page 286 for maintenance instructions.)

¹⁸ Ensure that all maintenance intervals leading up to this point are repeated during this interval prior to the completion of those listed here.

Every 30,000 mi / 48,000 km ¹⁸
<p>Steering Components - Steering Intermediate Shaft U-joints (OFF HIGHWAY or CITY DELIVERY)</p> <ul style="list-style-type: none"> Lubricate [EP NLGI #2 HD grease, -10 to 325°F (-23 to 163°C) range]. (Refer to Steering System on page 326 for maintenance instructions.)
<p>Steering Components - Drag link and Tie Rod Arm Ball Sockets (ON HIGHWAY)</p> <ul style="list-style-type: none"> Lubricate (Chevron Delo EP NLGI-2 grease or equivalent.) (Refer to Steering System on page 326 for maintenance instructions.)
<p>Fuel and Tanks - Fuel Tank Straps Fuel Tank on page 313</p>
<p>Electrical and Lights - Fuel and Diesel Exhaust Fluid Tank Sending Unit</p> <ul style="list-style-type: none"> Check the mounting screws and electrical connections for worn or damaged wires and connectors.
<p>Heating and Air Conditioning - Heater and Air Conditioner</p> <ul style="list-style-type: none"> Perform the checks per Heater and Air Conditioner Maintenance on page 313
<p>Air - Air Lines</p> <ul style="list-style-type: none"> Check condition and routing to prevent chafing (See Air Compressor on page 266 for maintenance instructions).
<p>Air - Air Dryer</p> <ul style="list-style-type: none"> Perform the checks listed; (Refer to Air Dryer Maintenance on page 267 for maintenance instructions.)

Every 60,000 mi / 96,000 km / 6 Months

¹⁸ Ensure that all maintenance intervals leading up to this point are repeated during this interval prior to the completion of those listed here.

Every 60,000 mi / 96,000 km / 6 Months ¹⁹
<p>Frame - Fifth Wheel</p> <ul style="list-style-type: none"> Inspect fifth wheel operation. (Refer to Fifth Wheel Monthly Maintenance on page 312 for maintenance instructions.)
<p>Frame - Engine Mounting</p> <ul style="list-style-type: none"> Inspect engine mounts every 60,000 miles (96,000 km.) (Refer to Engine Mounting on page 310 for maintenance instructions.) Contact an authorized vehicle OEM dealership if engine mounts need servicing.
<p>Front Axle - Vocational (PACCAR) - Steer Axle Wheel Ends: Oil Bath (Adjusted)</p> <ul style="list-style-type: none"> Synthetic SAE 75W-140, SAE 50. Mineral Oil SAE 75W, 75W-90, 75W-140, 80W-90, 85W-140. (Refer to Front Axle and Suspension on page 269 for maintenance instructions.)
<p>Front Axle - Vocational (PACCAR) - Steer Axle Semi-fluid (Adjusted)</p> <ul style="list-style-type: none"> Semi-Fluid Synthetic Grease: Delo SF, Mobil SCH 007. (Refer to Front Axle and Suspension on page 269 for maintenance instructions.)
<p>Front Axle - Vocational (PACCAR) - Steer Axle Grease Pack (Adjusted)</p> <ul style="list-style-type: none"> Heavy-Duty Multipurpose Lithium Base: #2 Grade. (Refer to Front Axle and Suspension on page 269 for maintenance instructions.)
<p>Front Suspension - Front Spring</p> <ul style="list-style-type: none"> Inspect for cracked leaves, worn bushings, and excessive corrosion. (Refer to Front Axle and Suspension on page 269 for maintenance instructions.)

¹⁹ Ensure that all maintenance intervals leading up to this point are repeated during this interval prior to the completion of those listed here.

Every 60,000 mi / 96,000 km / 6 Months ¹⁹
<p>Front Suspension - Spring Pins and Shackles</p> <ul style="list-style-type: none"> Inspect for worn parts and excessive joint clearance. Shim or replace as required. (Refer to Front Axle and Suspension on page 269 for maintenance instructions.)
<p>Front Suspension - Shock Absorbers</p> <ul style="list-style-type: none"> Inspect for leaking, body damage, and damaged or worn bushings. Replace as required. Check the shock mounting stud torque. (Refer to Front Axle and Suspension on page 269 for maintenance instructions.)
<p>Front Suspension U-bolts - U-bolts (ON HIGHWAY and VOCATIONAL)</p> <ul style="list-style-type: none"> Check the general condition and the tightness of the nuts. Tighten the U-bolts using a calibrated torque wrench to the specified torque value. (Refer to Suspension U-Bolts, Class 10.9 on page 339 for maintenance instructions.)
<p>Drive Axle - Linehaul (PACCAR) - Axle Assembly</p> <ul style="list-style-type: none"> Drain and replace MINERAL BASE lubricant.
<p>Drive Axle (Dana) - Axle Housing</p> <ul style="list-style-type: none"> Visually inspect for damage or leaks. (Refer to Drive Axle - Dana on page 274 for maintenance instructions.) Check oil level. Check "cold." Torque the drain plug. (Refer to Drive Axle - Dana on page 274 for maintenance instructions.)
<p>Drive Axle (Dana) - Air Shift Unit</p> <ul style="list-style-type: none"> Check the lubricant level. (Refer to Drive Axle - Dana on page 274 for maintenance instructions.)
<p>Drive Axle (Dana) - Lube Pump (OFF HIGHWAY)</p> <ul style="list-style-type: none"> Remove the magnetic strainer and inspect for wear particles. Wash in solvent and dry in air. (Refer to Drive Axle - Dana on page 274 for maintenance instructions.)

¹⁹ Ensure that all maintenance intervals leading up to this point are repeated during this interval prior to the completion of those listed here.

Every 60,000 mi / 96,000 km / 6 Months ¹⁹
<p>Drive Axle (Dana) - Lube Filter (OFF HIGHWAY)</p> <ul style="list-style-type: none"> • Change. (Refer to Drive Axle - Dana on page 274 for maintenance instructions.)
<p>Drive Axle (Dana) - Magnetic Drain Plug and Breather (OFF HIGHWAY)</p> <ul style="list-style-type: none"> • Clean or replace. (Refer to Drive Axle - Dana on page 274 for maintenance instructions.)
<p>Drive Axle (SISU)</p> <ul style="list-style-type: none"> • Drive Axle (SISU) Oil Servicing on page 277 • Drive Axle (SISU) Inspection on page 277 • Drive Axle - SISU Breather and Brakes on page 277
<p>Rear Suspension - U-bolts</p> <ul style="list-style-type: none"> • Check the torque. Tighten to specified torque value as required. (Refer to Suspension U-Bolts, Class 10.9 on page 339 for maintenance instructions.)
<p>Drum Brakes (All) - Brake Camshaft Bearing</p> <ul style="list-style-type: none"> • Check for excessive camshaft play in the axial and radial directions. Max allowable play is 0.003 in. Lubricate (NLGI #2 grease.) (Refer to Drum Brake Inspection on page 279 for maintenance instructions.)
<p>Drum Brakes (All) - Brake Air System</p> <ul style="list-style-type: none"> • Clean or replace the inline filters. (Refer to Air System on page 262 for maintenance instructions.)
<p>Disc Brakes (Bendix®) - Brake Pads</p> <ul style="list-style-type: none"> • Inspect: replace as required. (Refer to How to inspect brake pads on disc brakes on page 278 for maintenance instructions.)

¹⁹ Ensure that all maintenance intervals leading up to this point are repeated during this interval prior to the completion of those listed here.

Every 60,000 mi / 96,000 km / 6 Months ¹⁹
<p>Disc Brakes (Bendix®) - Brake Disc/rotor</p> <ul style="list-style-type: none"> Inspect for visible cracks, heat checking, galling, or scoring of surface. Check for runout (max allowable is 0.002 in.) (Refer to Air Disc Brakes on page 278 for maintenance instructions.)
<p>Disc Brakes (Bendix®) - Caliper Sliding Function</p> <ul style="list-style-type: none"> Ensure caliper slides freely with no obstructions or excessive play. (Refer to Air Disc Brakes on page 278 for maintenance instructions.)
<p>Disc Brakes (Bendix®) - Caliper Slide Pins</p> <ul style="list-style-type: none"> Inspect protective caps of the guide pins for damage or cracking. (Refer to Air Disc Brakes on page 278 for maintenance instructions.)
<p>Disc Brakes (Bendix®) - System Operation</p> <ul style="list-style-type: none"> Check operation: inspect as per manufacturer's service literature. (Refer to Air Disc Brakes on page 278 for maintenance instructions.)
<p>Hub, Drum, and Hubcap - LMS Hubs (Dana)</p> <ul style="list-style-type: none"> Inspect for leaks. Check the bearing endplay and adjust as required. (Refer to Wheels on page 332 for maintenance instructions.)
<p>Main and Auxiliary Transmission - Mounting Brackets and Fasteners</p> <ul style="list-style-type: none"> Check the condition of the fasteners and their torque. Tighten to the specified torque value as required. Refer to Frame Fastener Torque Requirements on page 336 for maintenance instructions.

¹⁹ Ensure that all maintenance intervals leading up to this point are repeated during this interval prior to the completion of those listed here.

Every 60,000 mi / 96,000 km / 6 Months ¹⁹
<p>Main and auxiliary Transmission - Oil Cooler</p> <ul style="list-style-type: none"> • Clean the fins (air-to-oil type) and body. Check the hose condition and for leaks: replace as required (See Cooling System Maintenance on page 286).
<p>Main and Auxiliary Transmission (including PACCAR TX-12/TX-18 or Eaton Endurant Transmission) - Main and Auxiliary Transmission (OFF HIGHWAY)</p> <ul style="list-style-type: none"> • Drain lubricant while warm. Flush each unit with clean flushing oil. (Refer to Transmission Maintenance on page 332 for maintenance instructions.)
<p>Auxiliary Transmission - Cotta Transfer Case TR2205 Fabco Transfer Case TC142/TC143/ TC170/ TC270 Marmon-Harrington Transfer Case MVG2000/ MVG2000SD</p> <ul style="list-style-type: none"> • Initial oil change: Drain oil while warm: flush case with gear oil-compatible fluid, clean magnetic drain plug, and refill. Do not flush the case with any solvent. • Change oil.
<p>Air Intake - Air Intake Piping, Mounting, and Charge Air Cooler</p> <ul style="list-style-type: none"> • Check the system for broken pipes, leaks, joint integrity, cleanliness, and proper support. (Refer to Air Intake System on page 307 for maintenance instructions.)
<p>Cooling - Hoses</p> <ul style="list-style-type: none"> • Check the radiator and heater hoses for leaks. (Refer to Cooling System Maintenance on page 286 for maintenance instructions.)
<p>Cooling - Fan Clutch</p> <ul style="list-style-type: none"> • Check for air leaks. Check the fan drive bearings (turn the sheave in both directions to check for worn hub bearings.) (Refer to Engine Fan on page 306 for maintenance instructions.)

¹⁹ Ensure that all maintenance intervals leading up to this point are repeated during this interval prior to the completion of those listed here.

Every 60,000 mi / 96,000 km / 6 Months ¹⁹
<p>Cooling - Solenoid Valve</p> <ul style="list-style-type: none"> • Check the fan drive for proper engagement and disengagement. (Refer to Engine Fan on page 306 for maintenance instructions.)
<p>Power Steering - Reservoir (OFF HIGHWAY)</p> <ul style="list-style-type: none"> • Drain, replace the filter, and refill. (Refer to Check Power Steering Fluid Level on page 327 for maintenance instructions.)
<p>Power Steering - Steering Gear</p> <ul style="list-style-type: none"> • Check the lash of the sector shaft: adjust as required. (Refer to Steering System on page 326 for maintenance instructions.) • Grease the trunion bearing (Chevron Delo EP NLGI-2 grease or equivalent.) (Refer to Steering System on page 326 for maintenance instructions.) • Grease the input shaft seal (Chevron Delo EP NLGI-2 grease or equivalent.) (Refer to Steering System on page 326 for maintenance instructions.)
<p>Power Steering - Hoses and Tubes</p> <ul style="list-style-type: none"> • Check for leaks and chafing. (Refer to Steering System on page 326 for maintenance instructions.)
<p>Steering Components - Drag link Tube Clamp and Ball Socket</p> <ul style="list-style-type: none"> • Check the torque: tighten to specified torque value as required. (Refer to Steering System on page 326 for maintenance instructions.)
<p>Steering Components - Pitman Arm Clamp Bolt and Nut</p> <ul style="list-style-type: none"> • Check the torque: tighten to specified torque value as required. (Refer to Steering System on page 326 for maintenance instructions.)

¹⁹ Ensure that all maintenance intervals leading up to this point are repeated during this interval prior to the completion of those listed here.

Every 60,000 mi / 96,000 km / 6 Months ¹⁹
<p>Steering Components - Steering Intermediate Shaft</p> <ul style="list-style-type: none"> • Check the torque on the pinch bolt and nut. (Refer to Steering Shaft Bolt Torque Specifications on page 328 for maintenance instructions.)
<p>Steering Components - Steering Intermediate Shaft U-joints (ON HIGHWAY)</p> <ul style="list-style-type: none"> • Lubricate [Chevron Delo EP NLGI-2 grease or equivalent]. (Refer to Steering System on page 326 for maintenance instructions.)
<p>Fuel and Tanks - Fuel Tanks</p> <ul style="list-style-type: none"> • Inspect tanks, brackets, hoses, and fittings for correct location, tightness, abrasion damage, and leaks: repair or replace as required. (Refer to Fuel Tank on page 313 for maintenance instructions.)
<p>Driveshafts - Models SPL- 140/140HD/170/170HD/250/250HD Slip Members and U- joints (ON HIGHWAY and LINEHAUL)</p> <ul style="list-style-type: none"> • Lubricate*
<p>Battery Boxes, Tool Boxes, and Steps - Batteries (ON HIGHWAY and LINE HAUL)</p> <ul style="list-style-type: none"> • Check for cracks and damage, electrolyte level, condition of terminals, and tightness of hold downs. Refer to Batteries on page 296 for maintenance instructions.
<p>Battery Boxes, Tool Boxes, and Steps - Battery Box and Tray (ON HIGHWAY and LINE HAUL)</p> <ul style="list-style-type: none"> • Check the box integrity. Clean the drain tube and check for acid leaks. Check condition of all equipment mounted under the box. Check the drain tube and check for acid leaks. Check condition of all equipment mounted under the box. (Refer to Batteries on page 296 for maintenance instructions.)

¹⁹ Ensure that all maintenance intervals leading up to this point are repeated during this interval prior to the completion of those listed here.

* Use only Spicer Driveshaft approved lubricants when greasing Spicer U-joints.

Every 60,000 mi / 96,000 km / 6 Months ¹⁹
<p>Electrical and Lights - Alternator</p> <ul style="list-style-type: none"> • Check operation and output. (Refer to Alternator on page 301 for maintenance instructions.) • Check tightness of the pulley nut. (Refer to Install Engine Belt on page 305 for maintenance instructions.) • Check the tension of the drive belt. (Refer to Install Engine Belt on page 305 for maintenance instructions.) • Check tightness of the terminal hex nuts. (Refer to Install Engine Belt on page 305 for maintenance instructions.)
<p>Electrical and Lights - Starter</p> <ul style="list-style-type: none"> • Check torque on hex nuts. (Refer to Electrical System on page 294 for maintenance instructions.)
<p>Electrical and Lights - ECM Connector</p> <ul style="list-style-type: none"> • Check the tightness of the ECM connector. (Refer to Electrical System on page 294 for maintenance instructions.) for maintenance instructions.)
<p>Electrical and Lights - Wheel Sensors</p> <ul style="list-style-type: none"> • Check for damaged sensors and connectors, and worn or frayed wires. (Refer to Electrical System on page 294 for maintenance instructions.)
<p>Electrical and Lights - Power Supply Harnesses (engine, Transmission, etc.)</p> <ul style="list-style-type: none"> • Check for worn or damaged insulation, corroded terminals, frayed. Wash to remove excess grease. (Refer to Electrical System on page 294 for maintenance instructions.)
<p>Cab Structure, Doors and Hoods - Body and Cab Hold down Bolts, Cab Structure, Doors and Hoods on page 285</p>
<p>For Cab Structure, Doors, Hoods – Hinges and Latch (EXCLUDING door hinges)</p> <ul style="list-style-type: none"> • Lubricate with silicone spray. (Refer to Cab Structure, Doors and Hoods on page 285 for maintenance instructions.)

¹⁹ **Ensure that all maintenance intervals leading up to this point are repeated during this interval prior to the completion of those listed here.**

Every 60,000 mi / 96,000 km / 6 Months¹⁹

Heating and Air Conditioning - Condenser

- Clear any debris from the front of the condenser. (Refer to [Heater and Air Conditioner Maintenance](#) on page 313 for maintenance instructions.)

Air - System

- Lubricate. (Refer to [Air System](#) on page 262 for maintenance instructions.)

Air - Inline Filters

- Replace elements or clean with solvent. (Refer to Replace Engine Air Filter for maintenance instructions.)

5

Every 120,000 mi / 192,000 km / Annually

Every 120,000 mi / 192,000 km / Annually²⁰

Frame - Frame Fasteners

- Check for tightness: tighten to the specified torque value as required. (Refer to [Frame Fastener Torque Requirements](#) on page 336 for maintenance instructions.)

¹⁹ Ensure that all maintenance intervals leading up to this point are repeated during this interval prior to the completion of those listed here.

²⁰ Ensure that all maintenance intervals leading up to this point are repeated during this interval prior to the completion of those listed here.

Every 120,000 mi / 192,000 km / Annually ²⁰
<p>Frame - Crossmembers and Mounting Brackets</p> <ul style="list-style-type: none"> Inspect for cracks and loose fasteners. Replace or tighten to the specified torque value as required. (Refer to Frame Fastener Torque Requirements on page 336 for maintenance instructions.)
<p>Front Axle - Linehaul (PACCAR) - Steer Axle Wheel Ends: Oil Bath (Adjusted)</p> <ul style="list-style-type: none"> Synthetic SAE 75W-140, SAE 50W. (Refer to Front Axle and Suspension on page 269 for maintenance instructions.)
<p>Front Axle - Linehaul (PACCAR) - Steer Axle Wheel Ends: Oil Bath (Adjusted)</p> <ul style="list-style-type: none"> Mineral Oil SAE 75W, 75W-90, 75W-140, 80W-90, 85W-140. (Refer to Front Axle and Suspension on page 269 for maintenance instructions.)
<p>Front Axle - Linehaul (PACCAR) - Steer Axle Semi-fluid (Adjusted)</p> <ul style="list-style-type: none"> Semi-Fluid Synthetic Grease: Delo SF, Mobil SCH 007. (Refer to Front Axle and Suspension on page 269 for maintenance instructions.)
<p>Front Axle - Linehaul (PACCAR) - Steer Axle Grease Pack (Adjusted)</p> <ul style="list-style-type: none"> Heavy-Duty Multipurpose Lithium Base: #2 Grade. (Refer to Front Axle and Suspension on page 269 for maintenance instructions.)
<p>Front Axle - Vocational (PACCAR) - Steer Axle Wheel Ends: Oil Bath LMS</p> <ul style="list-style-type: none"> Synthetic SAE 75W-90. (Refer to Front Axle and Suspension on page 269 for maintenance instructions.)
<p>Drive Axle - Linehaul (PACCAR) - Axle Shaft</p> <ul style="list-style-type: none"> Tighten the rear axle flange nuts to the specified torque value.

²⁰ Ensure that all maintenance intervals leading up to this point are repeated during this interval prior to the completion of those listed here.

Every 120,000 mi / 192,000 km / Annually ²⁰
<p>Drive Axle - Vocational (PACCAR) - Axle Shaft</p> <ul style="list-style-type: none"> Tighten the rear axle flange nuts to the specified torque value.
<p>Drive Axle (Dana) - Air Shift Unit</p> <ul style="list-style-type: none"> Remove the housing cover and drain the lubricant. Wash the parts thoroughly and dry in air. (Refer to Drive Axle - Dana on page 274 for maintenance instructions.)
<p>Drive Axle (Dana) - Breather</p> <ul style="list-style-type: none"> Clean or replace. (Refer to Drive Axle - Dana on page 274 for maintenance instructions.)
<p>Drive Axle (Dana) - Lube Pump (ON HIGHWAY)</p> <ul style="list-style-type: none"> Remove the magnetic strainer and inspect for wear particles. Wash in solvent and dry in air. (Refer to Drive Axle - Dana on page 274 for maintenance instructions.)
<p>Drive Axle (Dana) - Lube Filter (ON HIGHWAY)</p> <ul style="list-style-type: none"> Change. (Refer to Drive Axle - Dana on page 274 for maintenance instructions.)
<p>Drive Axle (Dana) - Magnetic Drain Plug and Breather (ON HIGHWAY)</p> <ul style="list-style-type: none"> Clean or replace. (Refer to Drive Axle - Dana on page 274 for maintenance instructions.)
<p>Drive Axle (Meritor Line Haul / ON HIGHWAY) - Lubricant Filter</p> <ul style="list-style-type: none"> Change the filter. (Refer to Drive Axle - Meritor on page 275 for maintenance instructions.)
<p>Drive Axle (Meritor Line Haul / ON HIGHWAY) - Input Shaft and Pinion Shaft</p> <ul style="list-style-type: none"> Check and adjust the endplay. (Refer to Drive Axle - Meritor on page 275 for maintenance instructions.)

²⁰ Ensure that all maintenance intervals leading up to this point are repeated during this interval prior to the completion of those listed here.

Every 120,000 mi / 192,000 km / Annually ²⁰
<p>Drive Axle (Meritor Line Haul / ON HIGHWAY) - Axle Shaft</p> <ul style="list-style-type: none"> Tighten the rear axle flange nuts to the specified torque value. (Refer to Drive Axle - Meritor on page 275 for maintenance instructions.)
<p>Drive Axle (Meritor Line Haul / ON HIGHWAY) - Interaxle Differential</p> <ul style="list-style-type: none"> Check the operation. (Refer to Drive Axle - Meritor on page 275 for maintenance instructions.)
<p>Drive Axle (Meritor City Delivery / OFF HIGHWAY) - Lubricant Filter</p> <ul style="list-style-type: none"> Change the filter. (Refer to Drive Axle - Meritor on page 275 for maintenance instructions.)
<p>Drive Axle (Meritor City Delivery / OFF HIGHWAY) - Input Shaft and Pinion Shaft</p> <ul style="list-style-type: none"> Check and adjust the endplay. (Refer to Drive Axle - Meritor on page 275 for maintenance instructions.)
<p>Drive Axle (Meritor City Delivery / OFF HIGHWAY) - Axle Shaft</p> <ul style="list-style-type: none"> Tighten the rear axle flange nuts to the specified torque value. (Refer to Drive Axle - Meritor on page 275 for maintenance instructions.)
<p>Drive Axle (Meritor City Delivery / OFF HIGHWAY) - Interaxle Differential</p> <ul style="list-style-type: none"> Check the operation. (Refer to Drive Axle - Meritor on page 275 for maintenance instructions.)
<p>Drive Axle (SISU)</p> <ul style="list-style-type: none"> Drive Axle (SISU) Oil Servicing on page 277 for maintenance instructions.) Drive Axle - SISU Breather and Brakes on page 277

²⁰ Ensure that all maintenance intervals leading up to this point are repeated during this interval prior to the completion of those listed here.

Every 120,000 mi / 192,000 km / Annually ²⁰
<p>Rear Suspension - Frame and Crossmembers Bolts</p> <ul style="list-style-type: none"> • Check the torque. Tighten to specified torque value as required. (Refer to Rear Axle and Suspension on page 272 for maintenance instructions.)
<p>Rear Suspension - Mounting Brackets and Fasteners</p> <ul style="list-style-type: none"> • Check the condition and the fastener torque. Tighten to the specified torque value as required. (Refer to Suspension U-Bolts, Class 10.9 on page 339 for maintenance instructions.)
<p>Hub, Drum, and Hubcap - Hubs (non-LMS) with Standard Seals</p> <ul style="list-style-type: none"> • Clean the components and check for excessive wear or damage. Change the oil and seal. (Refer to Wheels on page 332 for maintenance instructions.)
<p>Cooling - Extended Life Coolant (ELC)</p> <ul style="list-style-type: none"> • Perform lab analysis. If lab analysis shows coolant is unsuitable for continued use: Flush, drain, and refill. Add ELC Extender. (Contact your authorized PACCAR dealer to schedule a maintenance appointment.)
<p>Power Steering - Reservoir (ON HIGHWAY)</p> <ul style="list-style-type: none"> • Drain, replace the filter, and refill. (Refer to Check Power Steering Fluid Level on page 327 for maintenance instructions.)
<p>Steering Components - Steering Linkage</p> <ul style="list-style-type: none"> • Check all joints for excessive lash: replace as required. (Refer to Steering System on page 326 for maintenance instructions.)
<p>Fuel and Tanks - Fuel Tank Breathers</p> <ul style="list-style-type: none"> • Check for proper function: clean the drain hoses. (Refer to Fuel Tank on page 313 for maintenance instructions.)

²⁰ Ensure that all maintenance intervals leading up to this point are repeated during this interval prior to the completion of those listed here.

Every 120,000 mi / 192,000 km / Annually ²⁰
Driveshafts - Models SPL-140XL/ 170XL/250XL Slip Members and U- joints (OFF HIGHWAY and CITY) <ul style="list-style-type: none"> Lubricate
Cab Structure, Doors and Hoods - Body and Cab Hold down Bolts, Cab Structure, Doors and Hoods on page 285
Heating and Air Conditioning - Heater and Air Conditioner <ul style="list-style-type: none"> Full operational and diagnostic check. (Refer to Heater and Air Conditioner Maintenance on page 313 for maintenance instructions.)
Heating and Air Conditioning - Sleeper Air Filter <ul style="list-style-type: none"> Inspect and clean, replace if necessary. (Refer to Sleeper HVAC Air Filter on page 315 for maintenance instructions.)
Heating and Air Conditioning - Recirculation Cab Air Filter (ON HIGHWAY) <ul style="list-style-type: none"> Please contact an authorized dealer when the service interval is required to inspect the cabin recirculation air filter. (Refer to Replace the Recirculation Air Filter on page 315 for maintenance instructions.)
Heating and Air Conditioning - Recirculation Cab Air Filter (OFF-HIGHWAY) <ul style="list-style-type: none"> Please contact an authorized dealer when the service interval is required to inspect the cabin recirculation air filter. (Refer to Replace the Recirculation Air Filter on page 315 for maintenance instructions.)
Air - Air Dryer <ul style="list-style-type: none"> Replace cartridge (See Air Dryer Maintenance on page 267). Replace purge valve.

²⁰ **Ensure that all maintenance intervals leading up to this point are repeated during this interval prior to the completion of those listed here.**

* Use only Spicer Driveshaft approved lubricants when greasing Spicer U-joints.

Every 240,000 mi / 384,000 km

Every 240,000 mi / 384,000 km ²¹
Drive Axle - Vocational (PACCAR) - Axle Assembly <ul style="list-style-type: none">• Drain and replace SYNTHETIC BASE lubricant.
Hub, Drum, and Hubcap - Hubs (non-LMS) with Outrunner Seals <ul style="list-style-type: none">• Clean the components and check for excessive wear or damage. Change the oil and seal. (Refer to Wheels on page 332 for maintenance instructions.)

Every 300,000 mi / 480,000 km / 6,750 Hours / 3 Years

Every 300,000 mi / 480,000 km / 6,750 Hours / 3 Years ²²
Cooling - Extended Life Coolant (ELC) <ul style="list-style-type: none">• Replace blank water filter, if applicable. (Refer to Cooling System Maintenance on page 286 for maintenance instructions.)

²¹ Ensure that all maintenance intervals leading up to this point are repeated during this interval prior to the completion of those listed here.

²² Ensure that all maintenance intervals leading up to this point are repeated during this interval prior to the completion of those listed here.

Every 300,000 mi / 480,000 km / 6,750 Hours / 3 Years²²

Hub, Drum, and Hubcap - LMS Hubs (Dana) with Mineral Lubricant

- [Wheels](#) on page 332

Every 500,000 mi / 800,000 km / 5 years

Every 500,000 mi / 800,000 km / 5 years²³

Front Axle - Linehaul (PACCAR) - Steer Axle Wheel Ends: Oil Bath LMS

- Synthetic SAE 75W-90. (Refer to [Front Axle and Suspension](#) on page 269 for maintenance instructions.)

Drive Axle - Linehaul (PACCAR) - Axle Assembly

- Drain and replace SYNTHETIC BASE lubricant.

Hub, Drum, and Hubcap - LMS Hubs (Dana) with Synthetic Lubricant

- Service the bearings, seals and oil. This interval may be different depending on the results of the regular inspection. (Refer to [Wheels](#) on page 332 for maintenance instructions.)

²² **Ensure that all maintenance intervals leading up to this point are repeated during this interval prior to the completion of those listed here.**

²³ **Ensure that all maintenance intervals leading up to this point are repeated during this interval prior to the completion of those listed here.**

Every 750,000 mi / 1,200,000 km/ 24,000 Hours / 8 years

Every 750,000 mi / 1,200,000 km/ 24,000 Hours / 8 years²⁴

Cooling - Extended Life Coolant (ELC)

- Flush, drain, and refill with new coolant. (Refer to [Cooling System Maintenance](#) on page 286 for maintenance instructions.)

Main and Auxiliary Transmission (including PACCAR TX-12/TX-18 or Eaton Endurant Transmission) - Main and Auxiliary Transmission (ON HIGHWAY)

- Drain lubricant while warm. Flush each unit with clean flushing oil. (Refer to [Transmission Maintenance](#) on page 332 for maintenance instructions.)

Air System

The operation of the vehicle's braking system and many vehicle accessories depends on the storage and application of a high-pressure air supply.



WARNING

DO NOT modify, alter, repair, or disconnect any air system component. Repairs or modifications to the air system, other than what is described in this section, should be performed by an authorized dealer, only. Failure to

comply may result in property damage, personal injury, or death.

²⁴ Ensure that all maintenance intervals leading up to this point are repeated during this interval prior to the completion of those listed here.



WARNING

Prior to the removal of any air system component, always block and hold the vehicle by a secure means other than the vehicle's own brake. Depleting air system pressure may cause the vehicle to roll unexpectedly resulting in an accident causing personal injury or death. Keep hands away from chamber push rods and slack adjusters, they may apply as system pressure drops.



WARNING

After completing any repairs to the air system, always test for air leaks, and check the brakes for safe operation before putting the vehicle in service. Failure to comply may result in death, personal injury, equipment or property damage.



WARNING

Never connect or disconnect a hose or line containing air pressure. It may whip as air escapes. Never remove a component or pipe plug unless you are certain all system pressure has been depleted. Failure to comply may result in death, personal injury, equipment damage, or property damage.



WARNING

Never exceed recommended air pressure and always wear safety glasses when working with air pressure. Never look into air jets or direct them at anyone. Failure to comply may result in property damage, personal injury, or death.



WARNING

Never attempt to install, remove, disassemble, or assemble a component until you have read and understood the recommended procedures. Some

components contain powerful springs, and injury can result if not properly disassembled. Use only proper tools, and observe all precautions pertaining to use of those tools. Failure to comply may result in property damage, personal injury, or death.



WARNING

Completely bypassing a Bendix® air dryer will bypass the system's pressure protection valves. This could lead to loss of air pressure or damage to the vehicle's air system, which could cause an accident involving death or personal injury. Always adhere to the manufacturer's procedure if it is necessary in an emergency to temporarily bypass a Bendix® air dryer. Failure to comply may result in death, personal injury, equipment or property damage.



WARNING

Use of an air dryer brand or model that differs from what was originally installed could cause the air system to not perform correctly unless the full air system design is reviewed and modifications are made to comply with Federal Motor Vehicle Safety Standard (FMVSS) 121 Air Brake Systems. Failure to abide by this warning and maintain compliance with FMVSS 121 could cause loss of vehicle control and may lead to serious personal injury or death.



WARNING

If the air tanks are not drained at the recommended frequency, water could enter the air lines and valves. This could cause corrosion or blockage, compromising brake system safety, which could lead to an accident. Failure to comply may result in death, personal injury, equipment damage, or property damage.

Your vehicle's compressor takes outside air and compresses it, usually to 100-120 psi (689-827 kPa). The compressed air then goes to the reservoirs to be stored until needed. When you operate your air brakes, the stored compressed air flows into the chambers where it is used to apply your truck and trailer brakes. That is why, when you push down on your brake pedal, you don't feel the same amount of pressure on the pedal that you do when you apply the brake on your car. All you are doing on your truck is opening an air valve to allow air to flow into the brake chambers. Contamination of the air supply system is the major cause of problems in air-operated components such as brake valves, and suspension height control valves. To keep contaminants to the lowest possible level, follow these maintenance procedures.

Daily Checks

- Drain moisture from the supply and service air tanks.
- Operate air devices to circulate lubricant within the unit.

Periodically

- Clean filter screens ahead of the valves by removing the screens

and soaking them in solvent. Blow dry with pressurized air before reinstalling them.

Twice a Year

- Maintain the air compressor to prevent excessive oil bypass. See your maintenance manual for details.
- Replace worn seals in valves and air motors as needed.

Air Gauges and Air Leaks



WARNING

DO NOT operate the vehicle if leakage in the air system is detected. Contact an authorized dealer (or any other properly equipped service center) if a leak is detected. Failure to check the brakes or follow these procedures could cause a system failure, increasing the risk of an accident. Failure to comply may result in death, personal injury, equipment damage, or property damage

If your vehicle is equipped with air brakes, it has two separate, additional air systems:

Primary and Secondary. Each air system is monitored by a gauge indicating system pressure in either pounds per square inch (psi), and/or kilopascals (kPa). The Primary gauge indicates pressure in the rear braking system:

Primary Air Pressure Gauge



The Secondary gauge indicates pressure in the front braking system:

Secondary Air Pressure Gauge



The Primary and Secondary Air Pressure gauges are shown in the Primary Gauges View on the Digital Display.²⁵

At start-up, the Primary and Secondary Air Pressure gauges may indicate red, and the Low Air System Pressure alarm may sound until the minimum operational pressure setpoint of 65 psi (448 kPa) is reached.^{26,27}

If the tanks are empty, this can take up to two minutes. If these gauges

- Remain red
- Turn red
- Indicate below 65 psi (448 kPa)

Or the Low Air System Pressure Alarm

- Turns on
- Does not turn off

Do not attempt to drive the vehicle until the problem is found and fixed: system pressure is too low for normal brake operation.

	NOTE
Park brakes lock up at 60 psi (414 kPa), the audible alarm will sound at 65 psi (448 kPa).	

How to Check the Compressed Air System for Leaks

	WARNING
DO NOT operate the vehicle if leakage in the air system is detected. Contact an authorized dealer (or any other properly equipped service center) if a leak is detected. Failure to check the brakes or follow these procedures could cause a system failure, increasing the risk of an accident. Failure to comply may result in death, personal injury, equipment damage, or property damage	

Check the compressed air system for leaks:

- After maintenance
- When an air system component is replaced
- When a leak is suspected
- Periodically, to ensure system integrity

²⁵ Low cab forward right-hand stand-up model uses additional physical gauges for Primary and Secondary Air Pressure.

²⁶ Low cab forward right-hand stand-up model also indicates low air pressure using a warning light in the physical gauges.

²⁷ The Low Air System Pressure alarm is not active when the engine is off.

To check for Air System leaks

1. Start the engine if not already running.
2. **Scroll** to either the Basic or Enhanced View to monitor Primary and Secondary Air Pressures:

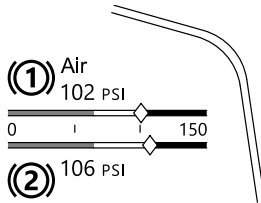

3. Build up air pressure in the system until the system cutout setpoint or until 120 psi (827 kPa) is reached.
4. Turn the Ignition Switch to OFF (stopping the engine) and then back to the ON position, but don't start the engine. The Basic or Enhanced View will appear.
5. Release the service brakes, and observe the rate of air pressure drop. This rate should not exceed 2.0 psi (14 kPa) per minute.
6. Start the engine and build up air pressure again.

7. Turn the Ignition Switch to OFF (stopping the engine) and then back to the ON position, but don't start the engine.
8. Apply the brake fully, holding the pedal down for five minutes. The pressure drop should not exceed 3.0 psi (21 kPa) per minute.
9. If you detect excessive leakage (air pressure loss greater than 3.0 psi (21 kPa) after five minutes of brake application), a leakage test should be made at the air line connections and at all air brake control units. These tests should determine where air is escaping.

Air Compressor

All compressors, regardless of make or model, run continuously while the engine is running. System pressure is controlled by the governor. The governor acts in conjunction with the unloading mechanism in the compressor cylinder block to start and stop compression of air. The compressor is unloaded when the system pressure reaches 130 psi (896 kPa), and compression is reestablished when system pressure falls to 110 psi (758 kPa).

Preventive Maintenance

The following service checks are provided for informational purposes, and should only be performed by a certified technician. Contact your dealer or the engine manufacturer's maintenance manual for further information on servicing air compressors. After completing any repairs to the air system, always test for air leaks, and check the brakes for safe operation before putting the vehicle in service. Below is a list of areas to maintain for the air compressor:

- Inspect compressor air filter element, if equipped, and replace element if clogged. Check compressor mounting and drive for alignment and belt tension. Adjust if necessary.
- Remove compressor discharge valve cap nuts and check for presence of excessive carbon. If excessive carbon is found, clean or replace the compressor cylinder head. Also, check compressor discharge line for carbon, and clean or replace the discharge line if necessary.
- Disassemble compressor and thoroughly clean and inspect all

parts. Repair or replace all worn or damaged parts, or replace compressor with a factory exchange unit.

Air Dryer Maintenance

	NOTE
<p>Because no two vehicles operate under identical conditions, maintenance and maintenance intervals will vary. Experience is a valuable guide in determining the best maintenance interval for any one particular operation.</p>	

	NOTE
<p>A small amount of oil in the system may be normal and should not, in itself, be considered a reason to replace the desiccant cartridge. Oil stained desiccant can function adequately.</p>	

Every 900 operating hours or 25,000 miles (40,000 km) or every 3 months check for moisture in the air brake system by opening air tanks, drain cocks, or valves and checking for presence of water.

A tablespoon of water found in the air tank would point to the need for a desiccant cartridge change. However, the following conditions can also cause water accumulation and should be considered before replacing the desiccant cartridge.

- Air usage is exceptionally high and not normal for a highway vehicle. This may be due to accessory air demands or some unusual air requirement that does not allow the compressor to load and unload (compressing and non-compressing cycle) in a normal fashion or it may be due to excessive leaks in the air system.
- In areas where more than a 30°F (17°C) range of temperature occurs in one day, small amounts of water can accumulate in the air brake system due to condensation. Under these conditions, the presence of small amounts of moisture is normal and should not be considered as an indication that the dryer is not performing properly.
- An outside air source has been used to charge the air system. This air did not pass through the drying bed.

	NOTE
<p>Review the warranty policy before performing any maintenance procedures. An extended warranty may be voided if unauthorized maintenance is performed during this period.</p>	

	NOTE
<p>Each time the oil-coalescing desiccant cartridge is changed, the air dryer purge valve should be changed.</p>	

Bendix® AD-HF Series Air Dryer

Your vehicle may be equipped with a Bendix® AD-HF series air dryer. Any air dryer replacement should be made with an identical component.



WARNING

Use of an air dryer brand or model that differs from what was originally installed could cause the air system to not perform correctly unless the full air system design is reviewed and modifications are made to comply with Federal Motor Vehicle Safety Standard (FMVSS) 121 Air Brake Systems. Failure to abide by this warning and maintain compliance with FMVSS 121 could cause loss of vehicle control and may lead to serious personal injury or death.

The AD-HF Series air dryer has incorporated into its design various components that have typically been installed separately on the vehicle (see below for components/areas affected):

- Pressure protection valves
- Safety valve
- Solenoid valves and plumbing
- Plumbing of the front and rear service air tanks
- Plumbing to accessory systems

These components are required to meet the Federal Motor Vehicle Safety

Standards (FMVSS 121 - Air Brake Systems). As the Warning above states, any other type of air dryer installed in the place of an AD-HF Series will require changes, modifications and/or additions to your vehicle's air system to maintain compliance with FMVSS 121.

Air Dryer Oil-Coalescing Cartridge

This vehicle's air system is equipped with an oil-coalescing air dryer. The air dryer's oil-coalescing cartridge must be replaced yearly, regardless of mileage.



CAUTION

Replace the oil-coalescing desiccant air dryer cartridge annually, regardless of mileage. Use only an oil-coalescing desiccant cartridge as a replacement. Failure to comply will void the transmission warranty and may cause transmission damage.

Air Tanks



WARNING

If the air tanks are not drained at the recommended frequency, water could enter the air lines and valves. This could cause corrosion or blockage, compromising brake system safety, which could lead to an accident. Failure to comply may result in death, personal injury, equipment damage, or property damage.



CAUTION

This vehicle may be equipped with an air actuated transmission. If so equipped, one tank will have two separate air supply's: vehicle air and transmission air. The transmission side of the air tank must be drained daily or transmission damage could occur. Failure to comply could result equipment or property damage.



CAUTION

DO NOT use penetrating oil, alcohol, brake fluid, or wax-based oils in the air system. These fluids may cause severe damage to air system components.

The air tanks must be drained daily. Operate air devices daily to circulate lubricants within the unit.

Air Tank Maintenance

Moisture builds up in the air tanks. The air tanks must be drained daily.

Moisture Ejection Valve

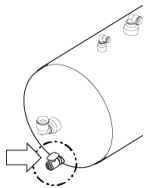

Pull Cord

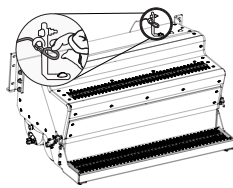

1. Turn the moisture ejection valve, or pull on the optional pull cord, until moisture comes out the valve.
2. Continue holding the knob, or the optional pull cord, until all moisture is released.

Dual Air System Function Test

Conduct this test at least every 3 months or if there is any indication of a potential problem.

Park the vehicle on level ground and block the wheels. Have an assistant open drain valves and, where required, observe brake action at the wheels. If a malfunction occurs during this test, do not move the vehicle until the problem has been corrected. Engine should be Off with the key switch to the ON or RUN position.



NOTE

Tractor air system must be connected to trailer.

Axles and Suspensions

Front Axle and Suspension

Axle Lubrication

Refer to the axle manufacturer's operator's manual for lubrication specifications and service intervals.

Kingpin Lubrication

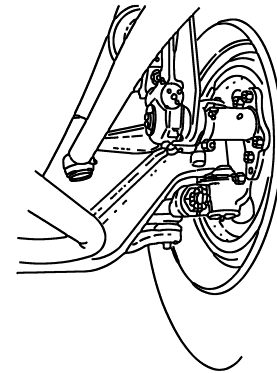

Lubricate with approved lubricant. Lubricate knuckle thrust bearings, knuckle pins, and tie rod ends. Lack of lubrication causes premature wear and hard steering. Lubrication schedule may be shortened if necessary.

Suspension Lubrication

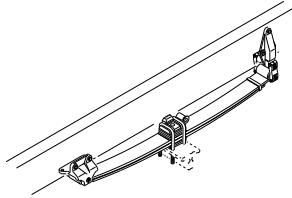

Each standard spring anchor pin has a grease fitting. Pressure lubricate spring pins as specified. At regular intervals, the spring leaves may be lubricated with a rust-inhibiting oil applied with a spray gun or brush. Depending on your suspension, lubricate all spring pins until grease flows out of both ends of the bushing. Look for signs of rust or water in the flushed grease. If a pin will not accept grease, it should be removed, cleaned, and inspected.



CAUTION

DO NOT spray the suspension with chemical products or mineral oil; it can cause damage to the bushings.

Inspection

For all vehicles, mandatory maintenance procedures include retightening all U-bolts and inspecting the suspension for loose, damaged, or abnormally worn fasteners. Visually inspect the shock absorbers, the rubber bushings, the leaf springs, and that the suspension is aligned and functioning properly. Mono leaf spring suspensions should also have their rear shackle brackets checked for proper alignment. Even with proper maintenance, however, the service life of leaf springs are affected by many factors: fatigue, vehicle gross weight, type of load, road conditions, and vehicle speed. Check for cracks, wear marks, splits, or other defects on the surface of the spring. Defective parts must be replaced. Because repaired springs cannot be fully restored to their original service life, replace the complete assembly if cracks or other defects are detected.

Wheel Alignment

For driving safety and comfort, and to prolong the life of your vehicle, it is important to have wheels correctly aligned. Check tire wear frequently. Uneven tire wear is a sign that the wheels may be misaligned. If you see uneven wear, take your vehicle to an authorized dealer familiar with aligning wheels on your vehicle.

Suspension U-Bolts

It is important that U-bolts remain tight. Severe use of your vehicle will cause them to loosen faster, and all vehicles need to have their U-bolts checked and tightened regularly. Be sure someone with the proper training and the right tools checks and tightens the U-bolts on your vehicle. New springs can settle in after service, relieving the tension on the U-bolts. Loose U-bolts can cause leaf spring breakage, axle misalignment, hard steering, and abnormal tire wear. All vehicles should have suspension U-bolts tightened after the first 500 miles (800 km) of operation. Re-torque the front spring pinch bolts and shackle pinch bolts.



WARNING

DO NOT operate the vehicle if the suspension U-bolts are not properly tightened. Improperly tightened (loose) suspension U-bolts can lead to an unsafe vehicle condition, including hard steering, axle misalignment, spring breakage, or abnormal tire wear. Failure to comply may result in death, personal injury, equipment or property damage.

U-bolts are difficult to tighten unless you have the right equipment. If you cannot tighten them correctly yourself, be sure to have them checked and tightened regularly by an authorized technician. Tighten U-bolt nuts to the specified torque value with the vehicle loaded to its normal gross weight. See [Suspension U-Bolts, Class 10.9](#) on page 339 specifications for torque values applying to U-bolts and nuts.



WARNING

DO NOT replace U-bolts and nuts with common U-bolts or standard nuts.

These parts are critical to vehicle safety. If the wrong U-bolts or nuts are used, the axle could loosen or separate from the vehicle and cause a serious accident. Use only PACCAR replacement parts. Failure to comply may result in death, personal injury, equipment or property damage.

PACCAR FX-20 Front Axle Lubrication

Proper lubrication practices are important in maximizing the service life of the steer axle assembly.

Kingpins, Thrust Bearings, and Tie Rod Ends

On-Highway Applications - Standard

- Pressure lubricate every 6 months or 25,000 miles (40,000 km).
- A more frequent lubrication cycle is required for axles used in on/off-highway, refuse, or other severe service applications. Use heavy-duty, multipurpose lithium base (#2 grade) grease.



NOTE

DO NOT mix with sodium-based grease.

PACCAR FX-20 Front Axle Lube Points

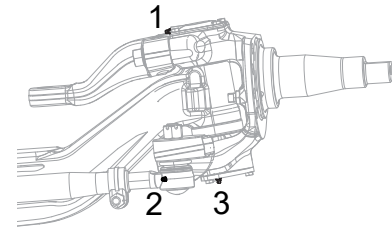

1. Upper kingpin bearing
2. Tie rod end
3. Lower kingpin bearing



NOTE

If it is difficult to grease either the upper or lower bearing, try greasing the bearings with the vehicle jacked up and supported on axle stands to improve grease flow and flush contamination.

Oil Bath

Lubricate wheel end assembly with a drive axle lubricant that meets MIL-L-2105D specifications. Either SAE 80W-90 mineral based or 75W-90 synthetic gear oil is acceptable. Check the lubricant level at each greasing interval. Maintain the lubrication fluid level at centerline of axle or fill line on hub cap. Always check fluid level on flat ground.



CAUTION

Never mix oil bath and grease-packed wheel ends. Mixing oil and grease will reduce the effectiveness of both lubricants and may cause damage to the wheel ends.

Rear Axle and Suspension

The vehicle's suspension, by design, requires a minimal amount of maintenance. However, suspensions in over-the-road operations require periodic inspection to ensure trouble-free performance.



WARNING

Prior to performing maintenance, do the following to prevent uncontrolled vehicle movement:

- Park the vehicle on a hard and level surface.
- Chock forward and rear wheels securely.

Failure to comply may result in death, personal injury, equipment damage, or property damage.



WARNING

DO NOT operate the vehicle if the suspension U-bolts are not properly tightened. Improperly tightened (loose) suspension U-bolts can lead to an unsafe vehicle condition, including hard steering, axle misalignment, spring



WARNING

Failure to maintain the specified torque values or to replace worn parts can cause component failure, possibly resulting in an accident. Improperly tightened (loose) suspension U-bolts can lead to unsafe vehicle conditions, including: hard steering, axle misalignment, spring breakage or abnormal tire wear. Failure to comply may result in death, personal injury, equipment or property damage.



CAUTION

DO NOT spray the suspension with chemical products or mineral oil; it can cause damage to the bushings.

	NOTE
Failure to follow these recommendations could void warranty.	

Visual Inspection

For all vehicles, mandatory maintenance procedures include retightening of U-bolts and complete inspection. Even with proper maintenance, however, many factors affect the service life of springs and suspension components: fatigue, vehicle gross weight, type of load, road conditions, and vehicle speed. All vehicles must have their U-bolts checked and tightened regularly. Severe use of the vehicle can cause them to loosen faster. It is important that U-bolts remain tight. Make sure that a technician with proper training and the right tools checks and tightens the U-bolts on the vehicle. After the first 500 miles (mi) (800 km) of operation, periodically inspect the suspension as noted below:

- Visually check for loose or missing fasteners, cracks in hanger, or axle connection brackets
- Check for centered springs in hangers that are in good condition

- Check for cracks, wear marks, splits, or other defects on the surface of the spring
- Replace defective parts. It is impossible to restore springs to their original service life. Replace the complete assembly if cracks or other defects are detected
- After replacement of any part or discovery of loose components, check the torque of all fasteners
- New springs settle-in after the vehicle's initial service, causing the U-bolts to become loose

Rear Suspension Fasteners

To maintain the performance of the air suspension, check fastener torque values after the first 2,000 miles (mi) (3,200 km) of service and every 60,000 miles (mi) (96,000 km) after. Torque recommendations apply to fasteners supplied and installed by vehicle manufacture. The values listed at the back of this chapter (See [Suspension U-Bolts, Class 10.9](#) on page 339 and [Frame Fastener Torque Requirements](#) on page 336), are for cadmium plated or phosphate and oil fasteners only.

Rear Suspension U-bolts

U-bolts are difficult to tighten unless you have the right equipment. If you cannot tighten them correctly yourself, make sure to have them checked and tightened regularly by an authorized technician.

	NOTE
To ensure an accurate torque reading, use properly maintained and calibrated torque wrenches. Clean the nut and bolt. No dirt, grit, or rust should be present.	

	WARNING
DO NOT operate the vehicle if the suspension U-bolts are not properly tightened. Improperly tightened (loose) suspension U-bolts can lead to an unsafe vehicle condition, including hard steering, axle misalignment, spring breakage, or abnormal tire wear. Failure to comply may result in death, personal injury, equipment or property damage.	



NOTE

Whenever possible, torque all frame fasteners on the nut end, not the bolt head.

Load the vehicle to its normal gross weight before tightening the U-bolts. Loading the vehicle ensures proper adjustment of the U-bolt and spring assembly.



WARNING

DO NOT replace U-bolts and nuts with common U-bolts or standard nuts. These parts are critical to vehicle safety. If the wrong U-bolts or nuts are used, the axle could loosen or separate from the vehicle and cause a serious accident. Use only PACCAR replacement parts. Failure to comply may result in death, personal injury, equipment or property damage.

Rear Axle Lubrication

See the axle manufacturer's operator's manual for lubrication specifications and service intervals.

Check oil level with the vehicle parked on level ground and the fluid warm. The level should be even with the bottom of the filler hole.

Rear Axle Alignment

Continual road shock and load stresses may force the rear axles out of alignment. If you detect rapid tire wear on the rear axles, you may have misaligned axles. If you suspect rapid tire wear, have your rear axle alignment checked and adjusted by an authorized dealer.

Suspension alignment should be checked when any one of the following conditions exist:

- Total vehicle alignment required after a body has been installed on truck chassis.
- Discovery of loose suspension fasteners (loose defined as any torque below the recommended torque value)
- Discovery of elongated holes in a suspension component
- Bushing replacement
- Excessive or abnormal tire wear
- Immediately after post body installation (See First Day in the Maintenance Chapter)

Drive Axle - Dana

Drain the lubricant while warm. Flush each unit with clean flushing oil. Change the lubricant.

Eaton/Dana Axle Lubrication

- The original mineral-based lubricant must be drained within 3,000-5,000 miles (4,800-8,000 km) on all Eaton axles. This initial change is very important because it flushes out break-in contaminants that might otherwise cause premature wear.
- No initial drain is required on Eaton axles that are factory filled with an Eaton-approved synthetic lubricant.
- Mineral-based lubes must be drained within the first 5,000 miles (8,000 km) if converting to an Eaton-approved synthetic lube.
- Change the lubricant within the first 5,000 miles (8,000 km) of operation after a carrier head replacement, regardless of the lubricant type.
- Refer to the *Eaton Field Maintenance Manual* for a particular axle for lubricant specifications.

- See your dealer for Eaton-approved lubricant brands.
- Refer to the chart below for lubricant change interval.

Eaton/Dana Axle Lubrication

Type of Lubricant	On-Highway Mi. (km)	Maximum Change Interval	On/Off Highway Severe Service Mi. (km)	Maximum Change Interval
Mineral-Based	120,000 (192,000)	Yearly	60,000 (96,000)	Yearly
Eaton-Approved Synthetic	240,000 (384,000)	2 Years	120,000 (192,000)	Yearly
Eaton-Approved Synthetic in axle with extended drain interval option	350,000 (560,000)			

Drive Axle - Meritor

Drain and replace the lubricant.

Under Meritor’s Advanced Lube Rear Drive Axle program, the axles listed below are exempt from an initial lubricant change:

Meritor Axle Lubrication

 NOTE
Axles utilized in 100% off-highway use are not eligible for Meritor’s Advanced Lube Rear Drive Axle program.

Available Advanced Lube Axles

RS-19-145	RS-26-180	RT-40-145P	RT-46-160
RS-21-145	RS-30-180	SQ-100A	RT-46-160P
RS-23-160	RT-34-145	SQ-100AP	RT-52-160
RS-23-161	RT-34-145P	RT-44-145	RT-52-160P
RS-17-145	RS-23-180	RT-40-145	RT-44-145P

Meritor rear axles that do not appear on the list above will continue to require an initial drain at 3,000-5,000 miles (4,800-8,000 km).

- Refer to the *Meritor Field Maintenance Manual* for a particular axle for lubricant specifications.

- See your dealer for Meritor-approved lubricant brands.
- Refer to the following chart for lubricant change intervals:

Application	Type Of Lubricant	Mileage Interval
On Highway	Synthetic	240,000 mi. (384,000 km)
	Synthetic with Pump and Filter	500,000 mi. (800,000 km)
	Mineral Base	120,000 mi. (192,000 km)
City Delivery	Synthetic	120,000 mi. (192,000 km)
	Synthetic with Pump and Filter	240,000 mi. (384,000 km)
	Mineral Base	120,000 mi. (192,000 km)

5

Application	Type Of Lubricant	Mileage Interval
Off Highway	Synthetic	120,000 mi. (192,000 km)
	Synthetic with Pump and Filter	120,000 mi. (192,000 km)
	Mineral Base	120,000 mi. (192,000 km)

- Change the lubricant filter every 120,000 miles (192,000 km). Top off the lubricant level with a similar lubricant

Drive Axle - SISU Breather and Brakes

1. Check the breather for proper operation.
2. Overhaul the brakes: degrease all moving parts, check the bushings and seals for wear.

Drive Axle (SISU) Inspection

1. Check the wheel bearing hubs and adjust if necessary.
2. Visually inspect for damage or leaks.

Drive Axle (SISU) Oil Servicing

Change the oil in the differential carrier and the hubs, and clean the magnetic oil drain plugs.

Drive Axle - SISU Lube Filter

Clean the suction filter for the optional pressure lubrication system.

Brake System

To learn more about brakes, see the Index, under Brakes.

 **WARNING**

Do not work on the brake system without the parking brake set, keys removed from the ignition, and wheels chocked securely. If the vehicle is not properly secured to prevent movement, it could roll unintentionally. Failure to comply may result in death, personal injury, equipment, or property damage.

 **WARNING**

DO NOT use brake linings with a thickness below the specified minimum. Such linings will have lining rivets exposed that can damage the brake drum and reduce brake efficiency, which could cause death, personal injury or system failure.



WARNING

DO NOT use any replacement part in the brake system unless it conforms exactly to original specifications. A nonconforming part in the vehicle's brake system could cause a malfunction resulting in a loss of vehicle control, leading to an accident. Failure to comply may result in death, personal injury, equipment damage, or property damage.



WARNING

The air brake system of this vehicle was configured for ONE of the following operations: tractor or truck, and complies with the respective portions of FMVSS 121. A tractor shall not be operated or configured as a truck, nor shall a truck be operated or configured as a tractor, without significant modifications to the air brake system in order to retain compliance with FMVSS 121. Contact your dealer for more information. Failure to comply may result in

death, personal injury, equipment damage, or property damage.

Brake adjustment and brake balance must be set carefully to make the most efficient use of the forces available for braking and to allow equal stopping forces at all wheels. Once a brake system is set to specifications, changing any one of its components or any combination of components may cause the system to not work as well. All parts have to work together to perform as they should. Any replacement components in your brake system should be exactly equal to the original components. Any changes from the original specifications can affect the whole system. All of the following areas are interrelated and must conform to original specifications:

- Tire size
- Drum brakes
- Cam radius
- Wedge angle
- Drum radius
- Brake linings
- Brake chambers
- Slack adjusters
- Disc brakes

- Disc rotors
- All vehicle operators should check their brakes regularly.

Air Disc Brakes

This vehicle may have disc brakes instead of drum brakes.

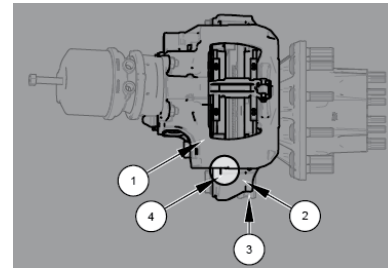

1. Brake caliper
2. Caliper mounting flange
3. Brake rotor
4. Inspection notches

How to inspect brake pads on disc brakes

To inspect the brake pads:

1. Park on level ground and chock the wheels.
2. Temporarily release the parking brake.

- Looking from the ground up at the bottom of the caliper and rotor, compare the relative position of two notches; one located on the caliper and the other on the carrier.
- Take a measurement from between these two notches and compare them to the specifications to determine if the pads need to be replaced.

Have a qualified mechanic perform a detailed inspection if the notches are not found. The pads and rotors should be measured and compared against the manufacturers specifications located in the brake manufacturer's service manual.

Inspect Disc Brake Caliper for Running Clearance

Regularly inspect caliper for Running Clearance:

- Stop the vehicle on level ground and let the brakes cool down. Hot brake calipers can burn skin on contact.
- Chock the wheels.
- Temporarily release the parking brake.
- Grab the caliper and move it. This movement is Running Clearance.

- Proper Running Clearance is 0.08 in. (2 mm) of movement of the brake caliper (approximately the thickness of a nickel) in the inboard/outboard direction.

Have a qualified mechanic provide further inspection if the caliper does not move or appears to move more than the specified clearance

Auto Slack Adjuster

The auto slack adjuster is a mechanism to maintain the correct amount of space between the braking surface and the friction material.

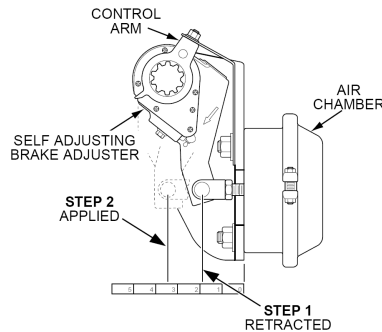

- Retracted position, no brake pedal applied

- Applied position, brake pedal engaged

Drum Brake Inspection

Have brake drum linings inspected by a qualified technician for wear at regular intervals according to the maintenance schedule. In severe service or off-highway applications inspect the linings more frequently. In addition, periodically check the brake chamber stroke. Replace the slack adjuster if proper stroke cannot be maintained.

Operational checks of automatic slack adjusters

- Start the vehicle and get the air system up to normal operating pressure. Do not apply the parking brake.
- Apply pressure to the brake pedal and measure the distance the air chamber pushrod traveled.
- Compare the results to the specification to determine if the automatic slack adjusters need replacing.

Automatic Slack Adjuster Stroke Specification

Chamber Type	Stroke
36 (rear brakes)	1.5-2.5 in. (38-63 mm)
30 (rear brakes)	1.5-2 in. (38-51 mm)
16, 20 and 24 (front brakes)	1-1.75 in. (25.4-44.4 mm)

Cab Maintenance

Cab exterior, interior, frame, and engine compartment components need maintenance to ensure longevity and safe operations. A clean vehicle also allows leaks to be detected easier.



WARNING

Always allow hot surfaces to cool down before attempting to work near

them. Failure to comply may result in personal injury or death.



WARNING

Handle cleaning agents carefully. Cleaning agents may be poisonous. Failure to comply may result in death, personal injury, equipment damage, or property damage.



WARNING

DO NOT use gasoline, kerosene, naphtha, nail polish remover, or other volatile cleaning fluids. They may be toxic, flammable, or hazardous in other ways. Failure to comply may result in death, personal injury, equipment damage, or property damage.



WARNING

DO NOT clean the underside of chassis, fenders, wheel covers, etc. without protecting your hands and arms. You may cut yourself on sharp edged metal

parts. Failure to comply may result in death, personal injury, equipment damage, or property damage.



WARNING

Moisture, ice, and road salt on brakes may affect braking efficiency. Test the brakes carefully after each vehicle wash. Failure to comply may result in death, personal injury, equipment damage, or property damage.

Vehicle Cleaning

- Observe all caution labels
- Always read directions on the container before using any product
- Do not use any solution that can damage the body paint
- Most chemical cleaners are concentrates that require dilution
- Only use spot removing fluids in well ventilated areas
- Any vehicle is subjected to deterioration from multiple causes (i.e. industrial fumes, ice, snow, corrosive road salt, etc.)

Exterior and Engine Compartment

Corrosive materials used to remove ice, snow, and dust from the road can collect on the entire vehicle with concentrated accumulations throughout the underbody and engine compartment. If these materials are not removed, accelerated corrosion (rust) can occur on underbody parts such as fuel lines, frame rails, floor pan, electrical and exhaust system, even though they have been provided with corrosion protection.

At least every spring, flush these materials from the entire vehicle, including the underbody and engine compartment, with plain water using light water pressure. On vehicles used in applications and/or areas that experience high usage of, or exposure to, corrosive materials, cleaning of the entire vehicle should be done more frequently. If desired, your dealer can do this service for you.



WARNING

Do not direct high pressure water onto electrical components, plug connectors, seals or flexible hoses on the engine. Failure to comply can accelerate corrosion and degrade electrical com-

ponent which may cause a fire or equipment damage. Failure to comply may result in death, personal injury, equipment damage, or property damage.



CAUTION

Do not direct high pressure water onto seals or flexible hoses. Water may enter the part which will contaminate the system lubricants and fluids. To prevent damage to these components, keep a gentle flow of water moving at all times. Failure to comply may result in equipment damage.

To prevent rust, keep chromed parts clean and protected with wax at all times, especially in winter conditions when the roads are salted.

- If necessary, use a commercial chrome cleaner to remove light rust.
- Chrome surfaces are best cleaned with fresh water. Wipe dry to preserve their luster. A commercial chrome cleaner will remove light rust. After cleaning, wax flat

surfaces and apply a thin coat of rust preventive lubricant around bolts or other fasteners.

- Clean aluminum wheels and bumpers with cool water. Tar-remover will get rid of heavy deposits of road grime. To prevent spotting, wipe aluminum surfaces dry after washing.
- Under corrosive conditions, such as driving on salted roads, clean aluminum parts with steam or high-pressure water from a hose. A mild automotive soap solution will help. Rinse thoroughly.

To maintain the tailpipe's quality finish, wash the tailpipe with a soft cloth, mild automotive soap, and water or glass cleaner. A non-abrasive chrome polish can be used sparingly on hard-to-clean areas. DO NOT clean your high-heat chrome using scouring pads, abrasive chrome polish, highly acidic chemical cleaners or any other abrasive cleaners. Even high quality stainless steel parts can rust under prolonged exposure to salt water, especially when the salt-laden moisture is held against the metal surface by road grime. It is important to frequently clean salty moisture and grime from stainless steel surfaces.

- If surface rust is encountered, wash the surface and use a commercial polishing compound to clean off the rust, followed by a coating of wax.
- Never use steel wool when cleaning stainless steel. Minute particles of the steel wool can become embedded in the surface of the stainless steel part and cause rust staining.

Weather Stripping

Frequent washing of the vehicle is required to remove road grime and contaminants that can stain and oxidize paint and accelerate corrosion of plated and polished metal surfaces. Waxing offers added protection against staining and oxidation. Do not apply wax in the hot sun and do not friction burn the paint with a buffing machine. Occasionally spray weather-stripping on doors and windows with silicone compound to help preserve resiliency. This is especially useful in freezing weather to prevent doors and windows from sticking shut with ice.



NOTE

To allow enough time for your vehicle's finish to cure, wait at least thirty days after the date of manufacture before waxing.

Cleaning Interior Vinyl and Upholstery



NOTE

Strong cleaning agents such as hand sanitizer, solvents, paint thinners, window cleaner and gasoline/ diesel fuel must never be used on your vehicle's interior. Repeated exposure to chemicals such as sunscreen, insect repellents containing DEET, or brake fluid may cause accelerated wear, tackiness, or discoloration of interior surfaces.

Wipe vinyl upholstery and lining with a good commercial upholstery cleaner. Do not use acetone or lacquer thinner. Clean fabric upholstery with upholstery shampoo specially formulated for this purpose.

- First remove loose dirt, dust, or debris with a vacuum cleaner.
- Use a soft brush to loosen caked-on dirt before vacuuming it away.
- Wipe the fabric surface with a slightly damp cloth and dry the seat fabric thoroughly. If the fabric is still dirty, wipe using a mixture of mild soap and lukewarm water, then dry thoroughly.
- If the stain does not come out use an upholstery shampoo specially formulated for this purpose. Test the cleaner on a hidden place to make sure it does not harm the fabric. Follow the instructions on the container.

Other interior surfaces may be cleaned using a mixture of mild soap and lukewarm water, or an automotive interior cleaner, used on its intended surface (i.e. use leather conditioner on leather surfaces, etc.).

Avoid frequent or repeated use of the following products on interior surfaces:

- Alcohol-based cleaners (including hand sanitizer)
- Methanol-based cleaners
- Bleach
- Acetone

- Any other strong solvent
- Abrasive cleaners
- Sunscreen

How to Wash the Exterior of the Vehicle

Your dealer has a number of vehicle care products and can advise you on which ones to use for cleaning the exterior and interior of your vehicle.

 **WARNING**

Handle cleaning agents carefully. Cleaning agents may be poisonous. Failure to comply may result in death, personal injury, equipment damage, or property damage.

 **WARNING**

DO NOT use gasoline, kerosene, naphtha, nail polish remover, or other volatile cleaning fluids. They may be toxic, flammable, or hazardous in other ways. Failure to comply may result in

death, personal injury, equipment damage, or property damage.

 **WARNING**

DO NOT clean the underside of chassis, fenders, wheel covers, etc. without protecting your hands and arms. You may cut yourself on sharp edged metal parts. Failure to comply may result in death, personal injury, equipment damage, or property damage.

 **WARNING**

Moisture, ice, and road salt on brakes may affect braking efficiency. Test the brakes carefully after each vehicle wash. Failure to comply may result in death, personal injury, equipment damage, or property damage.

 **WARNING**

DO NOT aim the water jet directly at a door lock or latch and tape over the key holes to prevent water from enter-

ing. An occupant could become trapped in the vehicle if water seeps into the lock cylinder and freezes. Prevent locks from freezing in the winter by squirting glycerin or lock deicer into the lock cylinders. If water should seep in, remove it with compressed air. Failure to comply may result in death, personal injury, equipment damage, or property damage.

 **NOTE**

To allow enough time for your vehicle's finish to cure, wait at least thirty days after the date of manufacture before waxing.

1. Begin by spraying water over the dry surface to remove all loose dirt before applying the car wash solution.



CAUTION

Do not direct high pressure water onto seals or flexible hoses. Water may enter the part which will contaminate the system lubricants and fluids. To prevent damage to these components, keep a gentle flow of water moving at all times. Failure to comply may result in equipment damage.



WARNING

Do not direct high pressure water onto electrical components, plug connectors, seals or flexible hoses on the engine. Failure to comply can accelerate corrosion and degrade electrical component which may cause a fire or equipment damage. Failure to comply may result in death, personal injury, equipment damage, or property damage.

- Do not wash the vehicle in direct sunshine.
- Do not spray water directly into the cab vents.

2. Using soapy water, wash the vehicle with a clean soft cloth or a soft brush made for automotive cleaning.
 -
 - Use cool water and a mild, automotive-type soap. Strong industrial detergents, cleaning agents and household-type soaps are not recommended and may damage the vehicle's paint.
 - Do not use stiff brushes, paper towels, steel wool, or abrasive cleaning compounds because they will scratch painted, plated, and polished metal surfaces.
3. Rinse painted surfaces with gentle water pressure frequently while washing to flush away dirt that might scratch the finishes during the washing operation.
4. Hose dirt and grime from the entire chassis.



WARNING

Do not direct high pressure water onto electrical components, plug connectors,

tors, seals or flexible hoses on the engine. Failure to comply can accelerate corrosion and degrade electrical component which may cause a fire or equipment damage. Failure to comply may result in death, personal injury, equipment damage, or property damage.



CAUTION

Do not direct high pressure water onto seals or flexible hoses. Water may enter the part which will contaminate the system lubricants and fluids. To prevent damage to these components, keep a gentle flow of water moving at all times. Failure to comply may result in equipment damage.

5. Wipe everything dry with a chamois to avoid water spots. To prevent water spotting, dry off the cosmetic surfaces with a clean cloth or chamois.
6. Remove road tar with an automotive-type tar remover or mineral spirits.

7. After cleaning and drying the entire vehicle, apply a quality automotive wax to protect the vehicle's finish.

Cab HVAC Fresh Air Filter Replacement

The fresh air filter for the cab HVAC is located in the air intake housing that is mounted to the firewall in the passenger side rear corner of the engine compartment. The filter can be replaced without using any tools.

1. Tilt the hood open.
2. Locate the air intake housing at the passenger side rear corner of the engine bay, below the rain tray.

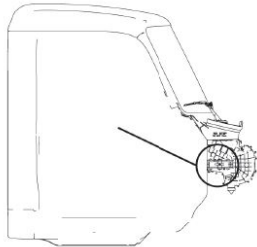

3. Locate the filter cover labeled "OPEN" with an arrow pointing towards the rear of the vehicle.

Slide the filter cover towards the rear of the vehicle, until you are able to remove the cover.

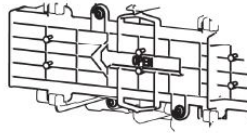

4. Remove and inspect the filter, referring to the maintenance interval schedule.
5. Install the new air filter into its housing, taking care to align the airflow direction indicated on the filter element with the airflow direction that's marked on the air intake housing.
6. Replace the filter cover on the air intake housing and slide the cover toward the front of the vehicle. An audible "snap" sound can be heard when the cover is correctly installed. If the snap feature is damaged there are two screw features that may be used to secure the cover.

7. Close and secure the vehicle's hood.

Display Screen Care

To clean the screen, dampen a clean, soft, and lint-free cloth with water only. A mild glass cleaner that does not contain alcohol or ammonia may also be used. Cleaners that contain alcohol and/or ammonia will eventually dry out, crack, and "yellow" the screen. Wipe the screen back and forth gently. You can also use a commercial cleaner specially designed for LCD screens.

Cab Structure, Doors and Hoods

Lubricate the lower hood pivot (only if lube fittings are present.)

Clutch

Hydraulic Clutch

The clutch pedal position is factory set and does not require adjustment.

Clutch Hydraulic Fluid

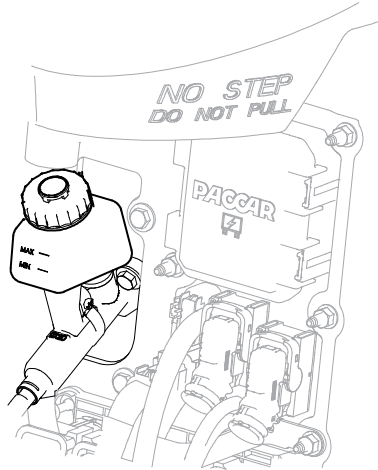

Visually inspect the clutch fluid from the reservoir. There are molded lines with the letters MIN to indicate minimum fluid level and MAX to indicate the maximum fluid level recommended for proper operation. Be sure to maintain the fluid between the MIN and MAX levels indicated on the plastic reservoir. If the fluid level repeatedly goes below the MIN line, then it is time to have your clutch adjusted or the hydraulic system inspected for service. To replace

the fluid, locate the drain fitting on the air solenoid mounted to the transmission housing. Open this fitting and allow fluid to drain out of the system. Once all the fluid is drained out, close the fitting and fill the system through the master cylinder reservoir in the engine compartment. Once the system is full, then purge the system of air by simultaneously pressing on the pedal and opening the fitting to allow air to escape. Close the fitting when fluid starts coming out. Then refill the reservoir. Repeat this until all air has been purged from the system. Replace with the recommended fluid per [Lubrication Specification Chart](#) on page 337.

Clutch Adjustment

Some clutches are self-adjusting, however; there are manually adjusted clutches that will require the operator to know when to adjust the clutch. The clutch will need adjustment when your clutch pedal stroke seems to get longer and its effectiveness at a seamless shift becomes less. Another sign of the clutch needing adjustment is the level of the fluid in the reservoir. If the hydraulic fluid is not leaking, but the fluid level is getting lower, then the clutch may need to be adjusted. Please take the vehicle to an authorized dealership to have

the clutch adjusted. See the clutch manufacturer's Service Manual for the proper adjustment procedures.

Cooling System Maintenance

The cooling system in your vehicle was factory filled with extended life coolant that meets or exceeds ASTM D6210, Cummins Engineering Standard 14603 for ISX and PX series engines, and MAT74002 Standard when equipped with an MX series engine. PACCAR recommends only using a 50/50 mixture of distilled water and ELC when cooling system service is required. A 50/50 mixture of ELC and distilled water will provide freeze protection down to -34°F (-36.7°C), which is adequate for most locations in North America. For extremely cold operating conditions, a 60/40 mixture (coolant/water ratio) can be used to provide freeze protection down to -62°F (-52.2°C).

Unless otherwise optioned, factory fill coolant is an ethylene glycol, nitrated organic acid technology (NOAT) extended life coolant (ELC) formulation at a 50:50 coolant-to-distilled water mixture. The factory fill meets or exceeds ASTM D6210

and Cummins Engineering Standard 14603 for ISX and PX engines, and MAT74002 for PACCAR MX-11 and MX-13 engine requirements. Maintaining coolant chemistry and freeze protection is critical to engine and cooling system component health and longevity.



WARNING

Coolant is toxic. Avoid contact with eyes. If contact occurs, rinse eyes with large amounts of water for 15 minutes. Avoid prolonged or repeated contact with skin. In case of contact, immediately wash skin with soap and water. DO NOT consume coolant. If swallowed, seek immediate medical attention. DO NOT induce vomiting. Failure to comply may result in death or personal injury.



CAUTION

The engine cooling system has very specific maintenance and inspection requirements. Failure to follow requirements can damage the engine. Engine damage can include but is not limited

to freezing, boiling, corrosion, pitted cylinder liners. This information is found in the engine manufacturer's owner's manual. It is the owner's responsibility to follow all requirements listed in the engine manufacturer's owner's manual. Failure to comply may result in engine damage.



CAUTION

Use of non-genuine PACCAR coolant filters can cause severe engine damage.



NOTE

Coolant is harmful to the environment. Unused coolant must be stored as a toxic hazardous material in leak-proof containers. Used coolant must be processed as industrial chemical waste. Please follow HAZMAT guidelines with both used and unused coolants.

Concentration

Check the level of freeze/boil-over protection, which is determined by the glycol concentration. Use a glycol refractometer to determine glycol level. Add coolant to obtain the coolant/water ratio required to provide the protection you need. A 50:50 mix of coolant and water is adequate for most applications. For extremely cold operating conditions, the ratio can be adjusted to a higher concentration of coolant.



NOTE

Maximum recommended ELC concentration is 60% ELC and 40% water by volume (a 60/40 coolant mixture). The minimum recommended concentration is 40% ELC and 60% water by volume (a 40/60 coolant mixture).

Glycol Concentration Level

Level	Desired Coolant / Water Ratio	Freeze Point °F (°C)
Recommended Levels	40%	-12 (-24)
	45%	-23 (-31)
	50%	-34 (-37)
	55%	-50 (-46)
	60%	-62 (-52)

Condition

Perform a visual inspection of the coolant. It should have no cloudiness or floating debris. Determine the chemical inhibitor concentration level by using an ELC specific test kit or test strips. Inhibitor concentration level determines corrosion protection. If you are concerned about possible coolant quality, contamination, or mechanical problems, submit a coolant sample for analysis. Improper maintenance may cause coolant degradation and could

result in damage to the cooling system and engine components. Consult your dealer or the coolant manufacturer's representative for recommended ELC test kits, test strips, and laboratory sample procedures.

Coolant Extender

Add ELC extender, if necessary, according to the corrosion inhibitor concentration required. DO NOT add coolant extender to nitrite-free coolant.

Checking Coolant Level

Check the coolant level daily. When adding coolant, avoid mixing different brands and formulations. If the coolant is mixed with more than 25% of a different formulation, engine corrosion damage can occur. If mixing exceeds 25% of total system volume, it is recommended to flush and refill the system completely with one type of coolant.

Coolant Filter

Your engine may be equipped with a coolant filter. It is a "blank filter" and does not contain chemicals or time-release additives. Replace it only with a blank filter at the interval specified in your engine's operator's manual. Never use filters that contain supplemental coolant additives

(SCAs) in an ELC-filled system. Consult your engine operator's manual for information on the coolant filter and service procedures.



CAUTION

The use of non-genuine PACCAR coolant filters may cause severe engine damage.

Cooling System Sealing Additives and Soluble Oils

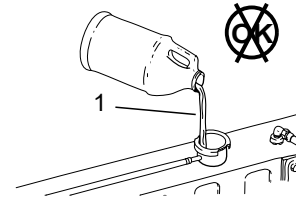

- Do not use soluble oils or sealing additives.



CAUTION

The use of sealing additives or soluble oils in the cooling system can cause damage to the engine. These additives can plug various areas of the radiator, EGR system, and oil cooler. Plugging the cooling system can prevent or slow heat transfers, causing internal engine damage. DO NOT use sealing additives or soluble oils in the cooling system. The use of sealing additives can

- Build up in coolant low-flow areas
- Plug the radiator and oil cooler
- Damage the water pump seal
- Damage heat transfer surfaces
- Damage seals and hoses
- Corrode brass and copper

Failure to comply may result in equipment or property damage.



NOTE

Gasoline engines require an unique engine coolant Organic Acid Technolo-

gy (OAT) (green color) compared to natural gas and diesel engines Nitrited Organic Technology (NOAT) (red color).

Inspect Coolant Level

Inspect the vehicle's coolant surge tank for proper coolant level. Add coolant if the level in the tank is below the line marked **MIN**.

The minimum fluid level is determined by the line on the surge tank indicated by the letters "MIN." This indicator is located below the fill cap. The cooling system will need to be filled if the level is not above the "MIN" line, regardless of engine temperature.

Radiator Mounted Coolant Surge Tank

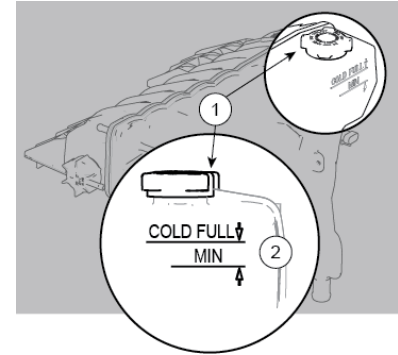

1. Fill cap (service point)
2. Fill line

Bulkhead Mounted Coolant Surge Tank

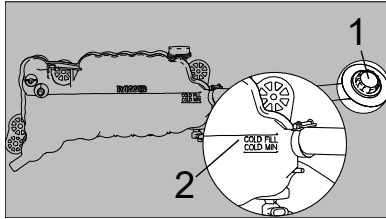

1. Fill cap (service point)
2. Fill line

Radiator Hoses Inspection

Perform this procedure for radiator hoses inspection.

1. Check the following radiator hose conditions:
 - Deterioration/signs of leaking
 - Hose clamp torque

How to Add Coolant to the Cooling System

! WARNING

DO NOT remove the coolant fill cap while the engine is hot. Wait until coolant temperature is below 120°F (50°C). Scalding steam and fluid under pressure may escape and cause serious burns. Failure to comply may result in death or personal injury.

! WARNING

Only use the fill port to fill the surge tank. DO NOT attempt to fill the tank using the pressure port. Scalding steam and fluid under pressure may escape and cause serious personal injuries. Failure to comply may result in death, personal injury, equipment damage, or property damage.

! WARNING

DO NOT touch, inhale, or swallow antifreeze or coolant. Many antifreeze/

coolant solutions contain ethylene glycol, which is poisonous. Failure to comply may result in death or personal injury.

! CAUTION

Do not overfill the cooling system. Excess coolant may overflow or result in loss of antifreeze and reduced corrosion protection. Failure to comply may result in equipment damage or property damage..

i NOTE

If the coolant frequently needs topping-up or there are any signs of coolant leakage, consult a PACCAR Service dealer.



NOTE

Store coolant and antifreeze carefully. Keep only in a dedicated, sealable container (ideally, the original packaging). Dispose of coolant/antifreeze responsibly.

Bulkhead Mounted Coolant Surge Tank

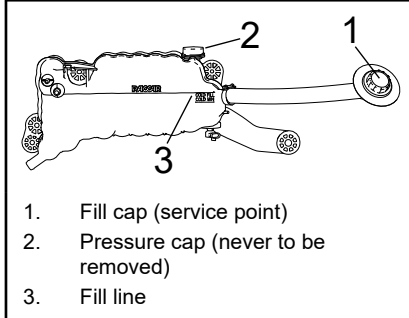

1. Fill cap (service point)
2. Pressure cap (never to be removed)
3. Fill line

Radiator Mounted Coolant Surge Tank

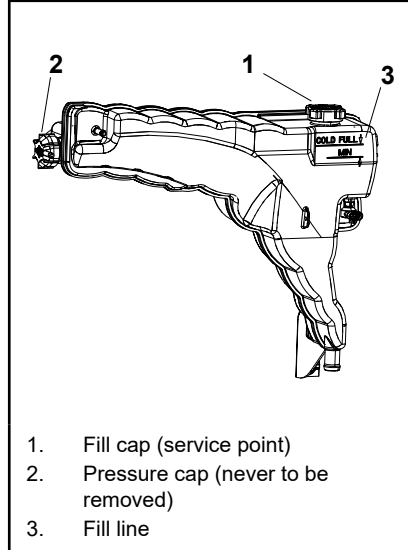

1. Fill cap (service point)
2. Pressure cap (never to be removed)
3. Fill line

1. Turn off the engine and let it cool for a minimum of 10 minutes.

2. If your cooling system is built with an air bleed valve in the upper engine coolant pipe, open the air bleed valve before filling the surge tank.
3. Close any open coolant drain valves in the lower engine coolant pipe.



CAUTION

Turning the key to ON allows the electric coolant pump for the 48V generator to run, purging air from the generator. Failure to comply may result in damage to the engine or 48V generator system

- If equipped with MX-13 CARB Emission engine, set key to ON position.
5. Remove the surge tank fill cap (1). DO NOT remove the surge tank pressure cap.
6. Fill the system with premixed coolant through the surge tank fill port. Pour coolant at a steady rate until it reaches the lower of the two lines indicated by either "COLD

MIN" or "MIN" on the surge tank. Wait for one minute after adding coolant. If the coolant level drops, add coolant until it returns to the lower line.

7. Close the air bleed valve if opened earlier in this procedure.



NOTE

If equipped with MX-13 CARB Emission Engine, confirm no stop lamp is illuminated on dash due to coolant pump fault. If a stop lamp is illuminated, stop the procedure and call service.

8. Start the engine and maintain an idle at low rpm.
9. While the engine is idling air will purge from the cooling system via the surge tank's coolant fill port, which will lower the coolant level in the surge tank. Continue to fill the surge tank until the coolant level remains approximately 1/2 in. (13 mm) above the "MIN" line. This may take up to 2 minutes, depending on the outside temperature.

10. Maintain a low idle until the thermostat opens and the operating temperature stabilizes. A sign that the thermostat has opened is when the upper coolant pipe gets hot on the bottom side indicating hot coolant is now running through it.
11. Add coolant to the surge tank until the coolant remains 1/2 in. (13 mm) above the "MIN" level.
12. Operate the engine at high idle for 10 minutes. Afterward, add coolant to the surge tank until the coolant remains 1/2 in. (13 mm) above the "COLD FULL" line.
13. Reinstall the surge tank fill cap.

Check the coolant level before and after each trip. Add coolant as necessary. Coolant may not immediately appear at the correct level after the radiator has been filled. Air may be trapped in the cooling system, which will affect the coolant level until the air is purged. After servicing the cooling system, continue monitoring it for 3-5 days. The coolant level in the surge tank will lower when air trapped in the cooling system is purged. During each pre-trip inspection you should inspect recently serviced

components of the cooling system for signs of coolant leaks.



NOTE

If the coolant frequently needs top-ping-up or there are any signs of coolant leakage, consult a PACCAR Service dealer.

Driveline

See the driveshaft manufacturer's operator manual for lubrication specifications and service intervals.



WARNING

Improper lubrication of U-joints can cause them to fail prematurely. The driveshaft could separate from the vehicle and result in an accident. Make sure lubricant is purged at all four ends of each U-joint and loosen caps if necessary. Also, regularly inspect U-joints for excessive wear or movement, and repair or replace as necessary. Failure to comply may result in death, personal injury, equipment or property damage.

Driver Assistance Maintenance

Cameras, radars, and sensors need maintenance to ensure longevity and safe operation. Clean components of the system allow the driver to operate the vehicle safely.



WARNING

Follow the daily maintenance tasks for the components of the driver assistance system to ensure a safe operation. Failure to comply may result in death, personal injury, equipment damage, or property damage.

FLC-25 Camera

- Inspect and keep the camera clean to ensure a clear view of the road ahead.
- Protect the camera lens whenever the inside of the windshield is cleaned. Within the viewing area of the camera the windshield has to be free of visible scratches and injuries.

FLC-25 Radar Sensor

- Inspect and keep the radar front and windshield clean and free of obstructions.
- Inspect for damage to the bumper and radar to ensure that the alignment has not been

compromised. **Never use the radar unit as a step.**



CAUTION

The installation of aftermarket deer guards, bumper guards, snow plows, or similar potential obstructions is not recommended and could impair the operation of the radar. Failure to comply may result in equipment or property damage.



WARNING

In cases where the bumper, radar and/or windshield have sustained any damage, are misaligned, or if the device is suspect for tampering, **DO NOT** use the active cruise control until the vehicle has been repaired and the radar re-aligned. In addition, an indicator on the dash typically will illuminate if the system detects any of these conditions. Failure to comply may result in death, personal injury, equipment damage, or property damage.

ECU - Bendix SDP5

- Protect the processor from damage or being moved from its set location in the overhead compartment.

Electrical System



WARNING

Battery posts, terminals and related accessories contain lead and lead compounds, chemicals known to the State of California to cause cancer and reproductive harm. Wash hands after handling. Failure to comply may result in death, personal injury, equipment damage, or property damage.



WARNING

Before attempting any work on the batteries or electrical system, remove all jewelry. If metal jewelry or other metal comes in contact with electrical circuits, a short circuit may occur causing

you to be injured, as well as electrical system failure and damage.



CAUTION

DO NOT modify or improperly repair the vehicle's electrical system or power distribution box. All electrical repairs should be performed by an authorized dealer. Improper repair or modifications will void your warranty and/or cause serious damage to your vehicle.

Engine Aftertreatment System Power Requirements



CAUTION

Before disconnecting battery power, wait at least 20 minutes after the ignition switch is turned OFF. The engine aftertreatment system (EAS) uses battery power to circulate DEF and prevent overheating of the DEF system. Failure to comply may result in proper damage.

For situations where the battery will be disconnected (for example, service or maintenance of the vehicle), please wait 20 minutes before disconnecting battery power.

Low Voltage Disconnect (LVD) (option)

The Low Voltage Disconnect (LVD) may extend battery life and prevent the battery from being drained below the charge required to start the engine. It does this by shutting off non-vital battery loads. When battery voltage drops below the LVD setting, LVD starts a two-minute countdown. If battery voltage remains below the LVD setting and the engine is not started, when the countdown ends, all non-vital battery loads (hotel loads) will be shut off. The LVD setting is adjusted in the Settings sub-menu of the Digital Display. When battery voltage drops below the LVD setting

1. An amber LVD notification occurs, accompanied by an audible warning. This starts the two-minute countdown.
2. Thirty seconds before the countdown ends, the Battery Voltage indicator is replaced by the

amber (or red) LVD telltale²⁸. The LVD notification will turn red and will be accompanied by a continuous audible warning.



- When the two-minute countdown has ended, the LVD “Hotel Loads Disconnected” notification appears, and LVD shuts off all loads connected through the LVD system.

The LVD condition will not clear until battery voltage increases above the LVD setting or the engine is started.

Electrical loads shut off by LVD

- Cab dome lamps
- Cab accessories
- Spare LVD wiring for customer added accessories

WARNING

DO NOT use the Spare Battery A and B circuits or other circuits that are con-

trolled by the LVD to power electronic engine controls, ABS circuits, or safety/work related lighting. Before adding any device to the vehicle's electrical system, consult your nearest authorized dealer or read the contents of TMC RP136. Failure to do so may cause equipment damage or lead to personal injury.

NOTE

The determination of what circuits/loads that were connected to the LVD was based upon the recommendation from Technology and Maintenance Council (TMC) of the American Trucking Association. To review the recommended practice, see TMC RP-136.

NOTE

All LVD circuits are color-coded blue on the central electrical panel cover label.

Fuses, Circuit Breakers and Relays

Fuses, circuit breakers, and relays are located in the Power Distribution Center (PDC) to the left of the steering column, behind the clutch pedal. Additional fuses are located in the engine compartment (driver's side firewall) and also in the sleeper (driver's side of vehicle) under the bunk storage compartment. Refer to the fuse labels affixed at each fuse panel location (generally under the fuse panel cover) for information about the location and amp ratings of each circuit.

Altering the Electrical System

Refer to a wiring diagram for your chassis before adding electrical options to ensure proper electrical system performance.

WARNING

DO NOT replace a fuse with a fuse of a higher rating. Doing so may damage the electrical system and cause a fire. Failure to comply may result in property damage, personal injury, or death.

²⁸ On the 15 inch display, LVD telltale color depends on the severity of battery depletion.



WARNING

Never install a circuit breaker/polyswitch in a location indicated for "fuse only." Using a polyswitch (circuit breaker) in a fuse-only circuit may cause the circuit to overheat when a short exists, which could lead to equipment damage and/or personal injury.



CAUTION

Follow all manufacturers' circuit protection recommendations for the components and wires being added. Failure to comply may result in equipment damage.



NOTE

If you are unfamiliar with proper electrical repair practices and procedures, see your authorized dealer for assistance.

Vehicle CAN Bus

Your vehicle is equipped with a CAN bus electrical system. Because of how the electrical system is designed it is important that any accessories added after the vehicle is built are installed only on the K-CAN or the S-CAN. These dedicated CANs are provided on the driver's side of the cab, near to the interior fuse panel. Access to the K-CAN and S-CANs is provided by two RP1226 connectors. DO NOT tap into, connect to, tamper with, or splice into any CAN network other than the K-CAN or the S-CAN. Connecting to an unapproved CAN network may trigger CAN fault codes.



CAUTION

Connecting to an unapproved CAN network may trigger CAN fault codes. The manufacturer will not warrant failures or damage caused to CAN network components when the failure or damage is a result of improper connections to the CAN network.



CAUTION

The use of scotch locks, scraped off insulation, and electrical tape are not approved CAN connection techniques. These are the source of numerous CAN faults.

Scotch locks

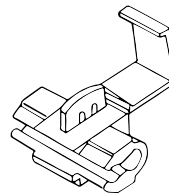

Batteries

Regular attention to the charging system helps prolong the service life of the batteries.



WARNING

Batteries contain acid that can burn and gases that can explode. Ignoring safety procedures may result in death, personal injury, equipment or property damage.



WARNING

Never remove or tamper with battery caps. Ignoring this could allow battery acid to contact eyes, skin, fabrics, or painted surfaces. Failure to comply may result in property damage, personal injury, or death.



CAUTION

DO NOT store other items in the battery box. Failure to comply could result in damage to the vehicle and/or batteries.



CAUTION

Properly secure battery tie downs and battery box cover when reinstalling batteries after service. DO NOT over tighten. Over tightening can crack the battery case which can lead to equipment damage.



CAUTION

The Diesel Exhaust Fluid (DEF) system recirculates fluid to the doser to prevent damage from heat after key off. Do NOT disconnect batteries within TWENTY minutes of switching off the ignition key (Emergencies are an exception). Failure to comply may result in vehicle or property damage.

Here are some common causes of battery failure:

- **Overcharge:** this condition results from improper voltage regulator adjustment. It results in overheating of the battery, warped plates, and the evaporation of electrolyte.

- **Undercharge:** the voltage regulator is malfunctioning, the drive belt is slipping, or your vehicle has undergone long periods of idling or short distance driving. These conditions result in the battery plates becoming covered with a hard coating.
- **Vibration:** loose battery hold-downs may cause battery plate failure.
- **Short Circuits:** these discharge the battery by draining electricity.
- **Dirty or Loose Connections:** improper connections may stop the flow of electrical power to and from the battery.

Battery Charging



WARNING

Batteries can injure you severely. They contain acid, produce poisonous and explosive gases, and supply levels of electric current high enough to cause burns. A spark or flame near a battery on charge may cause it to explode with great force. Never remove or tamper with the battery caps. Failure to comply may result in death, personal injury, equipment damage or property damage.

Only trickle charge the batteries to maintain battery condition. Have the batteries fully deep-charged by a qualified service facility. To help reduce the risk of personal injuries, follow these guidelines carefully when recharging a battery:

- Before attempting any service in the electrical installation, disconnect the battery negative cable.
- Allow no sparks or open flame anywhere near the charging area.
- Trickle charge a battery only in a well-ventilated area such as

outdoors or in a fully open garage. No open flames, including pilot lights can be present. Allow explosive gases generated during the charging process to escape.

- Always make sure that the battery charger is OFF before connecting or disconnecting the cable clamps.
- Never store or rest metal tools like jumper cables close to the battery. Metal must not come in contact with the positive battery terminal while also touching any other metal on the vehicle. The vehicle's body and frame are the electrical systems ground. Accidentally connecting the positive terminal directly to the frame or body could cause a short circuit and possibly an explosion.

Charging Reminders

- Use protective eyewear
- Keep all batteries away from children
- Never reverse battery poles
- Never attempt to place the vehicle in motion, or run the engine with the batteries disconnected
- Keep the battery clean and dry

- Look for any signs of damage
- Battery terminals must not be coated with improper grease. Use a commercially available, noncorrosive, non-conductive terminal coating, or petroleum jelly.
- Never use a fast charger as a booster to start the engine. This can seriously damage sensitive electronic components such as the relays, the radio, and battery charger. Fast charging a battery is dangerous and must only be attempted by a qualified technician with the proper equipment.

Under Cab Battery Access

The battery compartment is located on the left side of the vehicle, under the cab access steps.

1. Remove the six bolts that are located in the two cab access step plate.
2. Remove battery cover for access.

In Cab Battery Access

Your vehicle may be equipped with Absorbed Glass Mat (AGM) batteries located in the cab under the passenger's

seat. The glass mat in AGM batteries are designed to absorb the battery acid inside the battery that can leak or spill out in conventional batteries. This design feature allows batteries to be positioned in any orientation without risk of leaking.

To access the batteries:

1. Enter the cab.
2. Remove six fasteners securing the passenger side seat base to the battery box assembly.
3. Remove the seat and seat base as one unit to gain access to the batteries.
4. Installation is the reverse of removal.

Cranking Battery Specification

Category	Specification
Group	31
Stud Type	Threaded
Cold Crank Amps	650
Voltage	12 V
Reserve Capacity	160 minutes

Category	Specification
General	Maintenance free

Removing Batteries

After accessing the batteries, follow these steps to remove them from the vehicle.

CAUTION

Before disconnecting battery power, wait at least 20 minutes after the ignition switch is turned OFF. The engine aftertreatment system (EAS) uses battery power to circulate DEF and prevent overheating of the DEF system. Failure to comply may result in property damage.

1. Be sure all switches on the vehicle are turned OFF
2. Wait 20 minutes after turning ignition off before disconnecting the batteries
3. Disconnect negative (-) ground cable first
4. Disconnect positive (+) cable

5. Unscrew the holding plate bolts with an open end wrench

NOTE

Always dispose of automotive batteries in a safe and responsible manner. Contact your authorized dealer for disposal standards. Call your local authorized recycling center for information on recycling automotive batteries.

Follow the procedures below to reinstall batteries on the vehicle and replace parts removed for access.

Installing Batteries

Follow the procedure below to reinstall main batteries on the vehicle:

WARNING

Battery replacement may alter or disturb battery cable routing. Check to insure battery cables are free from any point of chaffing. Failure to comply may result in death, personal injury, equipment or property damage.



NOTE

Always dispose of automotive batteries in a safe and responsible manner. Contact your authorized dealer for disposal standards. Call your local authorized recycling center for information on recycling automotive batteries.



NOTE

Make sure to reconnect the ground (negative) cable last.

1. Place batteries in vehicle and tighten bolt of holding plate
2. Reconnect positive cable
3. Reconnect ground (negative) ground cable

Replace Battery Box Cover



WARNING

Always reinstall steps before entering the cab or accessing the deck plate. Without steps you could slip and fall.

Failure to comply may result in death or personal injury.



WARNING

Fairings not installed properly could come loose and cause other motorists to have an injury accident. It is important that fairings be installed properly. Failure to comply may result in death, personal injury, equipment or property damage.

1. Replace battery cover.
2. Install two bolts in step strut. Torque to 24-32 lb-ft (33-43 N·m).
3. Install fairing and install four bolts. Torque to 6-7 lb-ft (8-9 N·m).
4. Install steps by installing two bolts in each step. Torque to 24-32 lb-ft (33-43 N·m).



WARNING

Charger cables must be connected positive to positive (+ to +) and nega-

tive to negative (- to -). If connected improperly, batteries could explode. Failure to comply may result in property damage, personal injury, or death.



WARNING

Always make sure the battery charger is OFF before connecting or disconnecting the cable clamps to reduce the danger of explosions and resulting death or personal injury. Do not connect or disconnect charger cables while the charger is operating. Damage to the charging system may occur. Failure to comply may result in death, personal injury, equipment damage, or property damage.



NOTE

Some vehicles may have an ultra capacitor mounted in the battery box. These devices have a similar shape to a battery but have two positive posts and one negative posts. Do not attach battery chargers to these devices to recharge the vehicles batteries. Connect directly to the conventional two post charging batteries to charge them.



NOTE

Follow the instructions that come with your battery charger.

1. Access the battery terminals, the batteries do not have to be removed from the vehicle.
2. Make sure the battery charger is turned off.
3. Disconnect the battery cables.
4. Connect charger cables.
5. Start charging the battery at a rate not over 6 amperes. Normally, a battery should be charged at no

more than 10 percent of its rated capacity.

6. After charging, turn OFF charger and disconnect charger cables.

Alternator

Take the following precautions to avoid burning out alternator diodes:

- DO NOT start the engine with alternator disconnected (connections removed) from the circuit.
- Before welding, disconnect all electronic connections to the vehicle batteries.
- Remove battery power cable and insulate it from the vehicle.
- DO NOT run the engine with the batteries disconnected.
- DO NOT disconnect the battery cables or alternator connection cables with the engine running
- Never turn the ignition switch from the ON position to the START position with the engine running.
- When charging the battery (installed in the vehicle) disconnect the battery cables.

- DO NOT reverse the cables of the alternator, starter motor, or battery.
- DO NOT polarize the alternator. The alternator should not be polarized like a generator. To ensure correct polarity, use a test lamp or a voltmeter.

Remote Keyless Entry

The system will lock or unlock cab doors with the key fob. The system will alert you with parking lights when the selected doors are locked or unlocked. There are two key fobs provided with the system which provide secure rolling code technology that prevents someone from recording the entry signal.

If you have issues with a key fob, replace the battery and reprogram the key fob. In some situations, the key fob may need to be replaced and in others, a fuse may have failed that could render both key fobs inoperative. Contact your dealer for help if a key fob does not work and it is not because of a bad battery.

The key fob uses one CR2032, 3V battery. Batteries should last approximately three years, depending on use. Consistently reduced range is an indicator that the battery needs replacement. Batteries are

available at most discount, hardware, and drug stores. The battery can be accessed by removing the cover of the key fob. After a new battery is installed, the key fob may need to be reprogrammed to pair with the vehicle.

Quantity	Type
1	CR2032

5

How to Replace Key Fob Battery

If the key fob will not unlock the doors, replace the battery.

1. Remove the cover of the key fob.
2. Replace the battery and dispose of the old battery.
3. Check to see if the key fob is still paired to the vehicle. If not, reprogram the key fob.

Programming Key Fobs

The key fob may need to be paired with the truck when the battery is replaced or when the key fob has not been used for an extended period of time.

1. Turn the ignition switch to the ON position.
2. Open the driver and passenger doors.
3. Press and hold the passenger door's unlock button for 5 seconds, then release the button.
4. Within 3 seconds press and hold the passenger door's lock button for 5 seconds, then release the button. At this time you should hear the vehicle cycle the locking system by unlocking, then relocking the doors. (This indicates that the door module has entered "learning mode.")
5. Within the next 10 seconds, press and hold the key fob's lock button for 5 seconds, (you should hear the vehicle lock the doors) then press and release the unlock button.
6. Once programming is complete (or the 10 seconds from Step 5 has passed), the vehicle will cycle the locking system twice (unlock, lock, unlock, lock). This process should be repeated for each fob to be paired with the module. A maximum of five key fobs may be paired to a single module.

Engine Maintenance

These topics relate to the operator maintenance tasks for the engine. Information provided here is in addition to information contained in the Engine Operator Manual supplied with the vehicle.



WARNING

Exhaust fumes from the engine contain carbon monoxide, a colorless and odorless gas. DO NOT breathe the engine exhaust gas. A poorly maintained, damaged, or corroded exhaust system can allow carbon monoxide to enter the cab. Entry of carbon monoxide into the cab is also possible from other vehicles nearby. Failure to properly maintain your vehicle could cause carbon monoxide to enter the cab, resulting in personal injury or death.



WARNING

NEVER start or let the engine run in an enclosed, unventilated area. Engine exhaust fumes contain carbon monoxide, a colorless and odorless gas. Carbon monoxide can be fatal if inhaled. Failure to comply may result in death, personal injury, equipment damage, or property damage.



WARNING

Never idle your vehicle for prolonged periods of time if you sense that exhaust fumes are entering the cab. Investigate the cause of the fumes and correct it as soon as possible. If the vehicle must be driven under these conditions, drive only with the windows open. Failure to repair the source of the exhaust fumes may result in death, personal injury, equipment or property damage.



NOTE

Keep the engine exhaust system and the vehicle's cab ventilation system properly maintained. It is recommended that the vehicle's exhaust system and cab be inspected (1) By a competent technician every 15,000 miles (24,140 km); (2) Whenever a change is noticed in the sound of the exhaust system; or (3) Whenever the exhaust system, underbody, or cab is damaged.

Check Engine Oil Level



WARNING

DO NOT change hot engine oil as you could be burned. Let the engine cool down before changing the engine oil. Failure to comply may result in death, personal injury, equipment damage, or property damage.



NOTE

It takes approximately 15 minutes for all the oil to run into the sump when the engine is warm. If the level is checked immediately after switching off the engine, the dipstick will show a low oil level.

1. Make sure that the vehicle frame rail is standing on a flat and level surface.
2. Make sure that the vehicle is horizontal, both lengthwise and crosswise. Check this carefully on a vehicle with air suspension. Note that the engine may be inclined up to 4 degrees, depending on the vehicle model and wheelbase.
3. Twist the dipstick handle to unlock it, then pull the dipstick out of the holder.

5

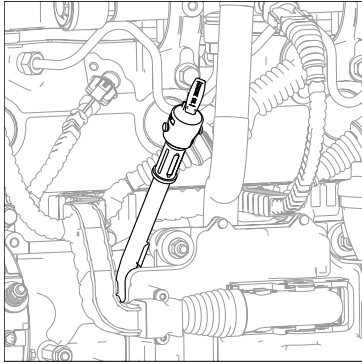

4. Wipe the dipstick clean with a lint-free cloth.
5. Place the dipstick back into the holder.
6. Pull the dipstick out again and check the oil level. The oil level should always be between the two marks on the dipstick.

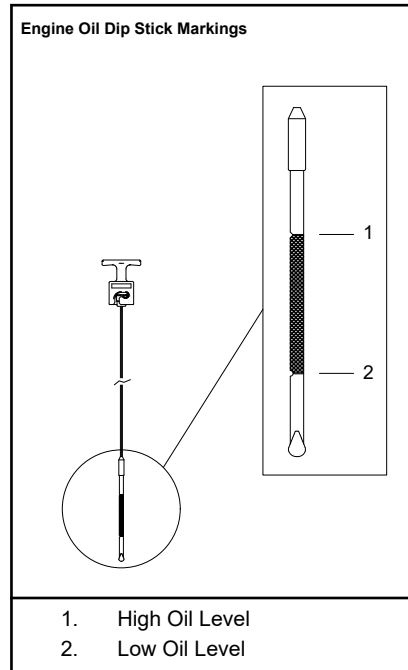

7. Reinstall the dipstick and twist to lock it in place.

Topping Up the Engine Oil

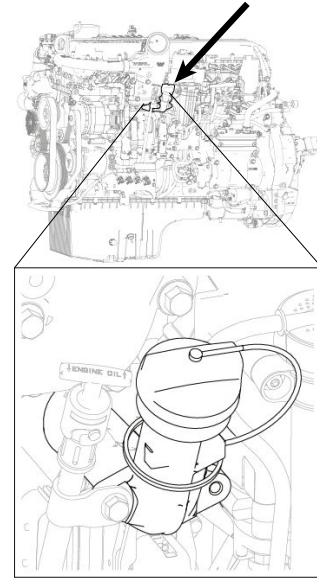

1. Top up with oil, if necessary, via the filler opening. Use the correct grade in the correct quantity. For oil replacement, please see engine Operator's Manual included with this chassis.

2. After topping up, wait 1 minute and check the oil level again.
3. Reinstall the oil fill cap and twist to lock it in place.

Pipe and Hose Clamp Torque Values

Torque specifications for engine parts.

Application	Type of Clamp	lb-in.	N•m
Radiator and Heat Exchanger Hoses	Constant Torque CT-L	90-110	10.2-12.5
Heater Hoses	Constant Tension	not required	not required
Air Intake Pipes	Hi Torque HTM-L	100-125	11.3-14.2
Plastic Air Intake Pipes	Constant Torque CT-L	88	10.0
Charge Air Intake Hoses	Flex Seal	70-100	7.9-11.3
	B9296	50-60	6-7
Fuel, Oil and Water Heat Exchangers (for hoses less than 9/16 in. diameter).	Miniature 3600L	10-15	1.1-1.7

Install Engine Belt

You can extend the reliability and service life of your vehicle's drive belts with proper attention to installation and maintenance. Neglect could cause belt failure. The result could be the loss of the electrical or air

system as well as possible engine damage from overheating.



NOTE

See the engine manufacturer's operator's manual for further information on replacing engine drive belts.

The images below may not appear like the configuration of the vehicle. The procedure is still the same. Follow this procedure to install an accessory drive belt:

1. Route the new belt around the pulleys, and then rotate the automatic tensioner so that the idler pulley swings toward the belt routing. The following figure shows an example of the rotation direction to release the tensioner.

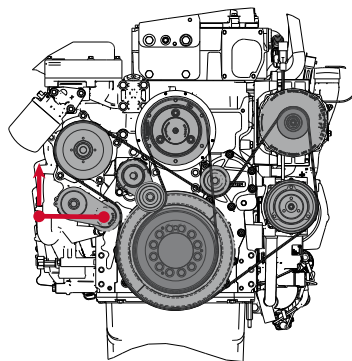
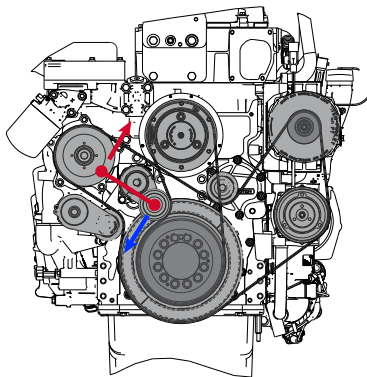

2. Slip the belt around the idler pulley attached to the automatic tensioner.
3. Release the automatic tensioner.
4. Check the belt alignment on each pulley. The belt must fall between the flanges of each pulley.

Engine Fan



WARNING

DO NOT work on or near the fan with the engine running. Anyone near the engine fan when it turns on could be injured. If it is set at MANUAL, the fan will turn on any time the ignition key switch is turned to the ON position. In AUTO, it could engage suddenly without warning. Before turning on the ignition or switching from AUTO to MANUAL, be sure no workers are near the fan. Failure to comply may result in death or personal injury.

Follow these guidelines to check your engine fan:

- With the engine shut off, check the fan hub bearings for looseness, loss of lubricant, and any abnormal conditions (e.g. fan belt misaligned or excessive wear/damage, etc.).
- With the engine idling and the hood open, stand at the front of the vehicle. Listen for any noises coming from the fan hub. Bearings that have lost lubricant and are dry will typically emit a squeal or a

growl when the engine is at operating temperature and the fan clutch is engaged. If noise is detected, have the fan bearings inspected by an authorized dealership.

Engine Fan Blade

Verify that there is enough fan blade clearance with the fan shroud. The recommended distance around the fan shroud is 1 in. (25 mm) from front edge of any fan blade-to-radiator side member. Minimum clearance is 3/4 in. (19 mm).

- Rear edge of any blade must be no closer than 3/8 in. (9 mm) to the nearest engine component. If this cannot be obtained, the fan spacer or fan is incorrectly placed.
- The leading edge of any fan blade must be 1 in. (25 mm) from the inside edge of the shroud.

Air Intake System

Engine heat, vibration, and age combine to loosen air intake connections and cause cracks in the tubing and elbows. Leaks in the intake system allow abrasive dust to enter the engine and quickly cause expensive damage. During your daily walk-

around inspection, carefully check all tubing, elbows, clamps, supports, and fasteners for condition and tightness. Check the charge-air-cooler for air leaks annually. The air leaks can be caused by cracked tubes or header. For service see your authorized dealer.

CAUTION

DO NOT use air intake pipes and connections as a step or to pull yourself up. This could loosen the connections and open the system to unfiltered air which could damage the engine.

Turbocharger

WARNING

DO NOT operate engine with turbocharger intake piping disconnected. A suction is created when the engine is running. This suction could draw your hand or anything else near it into the impeller fan. You could be injured. Always keep the intake piping connected

when you will be running the engine. Failure to comply may result in death, personal injury, equipment damage, or property damage

When servicing the air intake and exhaust systems on a turbocharged engine, check the items listed below:

Lubricating System

Check the oil lines, housing, and connections. Look for leaks, damage, or deterioration. Leaks could mean you have damaged oil lines or oil seals.

Manifold

With the engine operating, check for leaking manifold or flange gaskets.

High Frequency Vibration

Vibration may indicate turbo rotor imbalance. Have your dealer investigate this immediately. If you detect any deficiencies, take the vehicle to an authorized dealer for servicing. Delay could lead to severe and expensive damage to your vehicle.

Replace Engine Air Filter



CAUTION

Use only PACCAR-branded (Donaldson) engine air filters when replacement is needed. Using a non-genuine PACCAR air filter decreases sealing strength and impacts correct alignment. Failure to comply may result in equipment or property damage.



NOTE

If the vehicle is equipped with cab-mounted air cleaner and under hood air intake option, remove the air solenoid first.

1. Park the vehicle. Set the parking brake and turn the ignition OFF.
2. If the air cleaner is under the hood, open the hood to access the air filter housing.
3. Loosen the hardware that holds the housing cap to the main filter enclosure.
4. Pull the air filter housing cap away from the main enclosure to access the filter.
5. Visually inspect the filter housing, enclosure, and hardware for damage.
6. The filter can be removed by gently pulling it directly out of the main enclosure. Be careful not to drop or tap the filter on the housing during removal, as this could loosen dirt and dust trapped in the filter. DO NOT clean or reuse the original filter.
7. Inspect the sealing surfaces and clean out any debris from the inside of the filter enclosure before installing the new filter. Be careful to not push any contaminant into the engine inlet.
8. Visually inspect the new filter prior to installation. There should not be any damage to the filter media or gaskets, such as dents, dings, cracks, or holes.
9. After installing the filter, inspect for a good seal, if possible.
10. Install the filter housing cap and tighten the hardware. DO NOT use the housing cap to drive the filter into position.
11. Start the engine and allow the air system to reach operating pressure. Activate the under hood air switch and verify that there are no air leaks.

Remove and Install Solenoid on Air Filter Housing

These instructions are for removing and installing the under hood air intake solenoid from an air filter housing for vehicles with the firewall mounted air cleaner and optional under hood air intake switch on the dash. This solenoid must be removed to access the air filter. With the under hood air intake option, there is an additional step required to disconnect the air line attached to the air filter housing to access the air filter.



WARNING

Drain the air tank to depressurize the air system before disconnecting any air hoses. Failure to perform this step may result in personal injury.

CAUTION

Ensure no foreign debris enters in solenoid/airline. Failure to comply may result in equipment damage.

1. Park the vehicle, set the parking brake, and turn the ignition OFF.
2. Open the hood.
3. Drain front air service tank of all air pressure.
4. Disconnect the air line at the connection on the air filter housing.
5. Push in on the collar and then pull the air hose out.

WARNING

DO NOT disconnect any lines at the solenoid body. They could be pressurized which may result in personal injury.

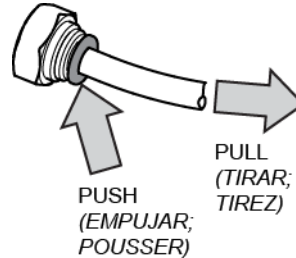
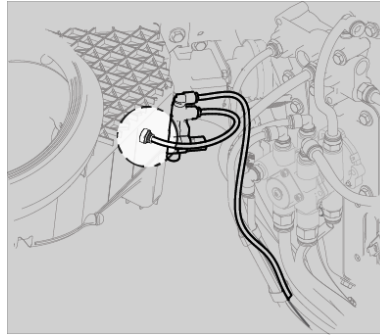

6. Remove the single bolt (with a 13 mm wrench) that holds the solenoid to the filter housing.

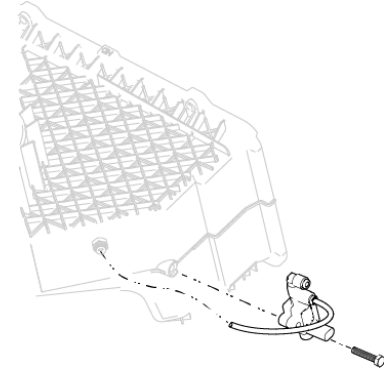

7. Cover the air hose end and the fitting with tape or something lint-free to keep the hose free from debris.
8. To reinstall the air solenoid to the filter housing, tighten the 13 mm bolt to 70 lb-in. ± 5 (7.9 N·m ± 0.56)
9. To reinstall the air line to the solenoid, push the air hose into the fitting, then pull on the air hose to ensure that it is properly seated.

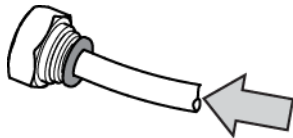

PUSH
(EMPUJAR;
POUSSER)

- Verify that there are no air leaks, start the engine and allow the air system to reach operating pressure. Activate the under hood air switch and verify that there are no air leaks.

Disconnecting the air solenoid will allow the air filter housing to be removed to access the air filter.

Air Filter Restriction Indicator (Option)

An Air Filter Restriction Indicator may be installed on the air filter housing or air induction piping for access to clean, filtered air.

As the filter plugs and restriction increases, a red indicator appears in a window on the indicator. When the indicator turns on, the air filter should be replaced. The indicator

can be reset by pressing the button at the end of the indicator.

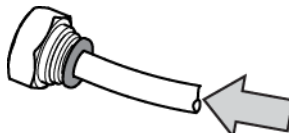
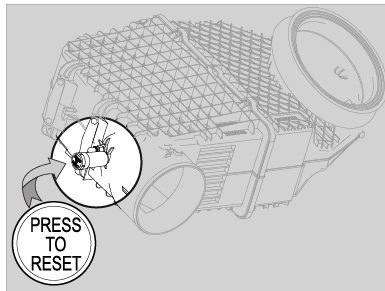

PUSH
(EMPUJAR;
POUSSER)

Exhaust System

The exhaust system is part of the noise and emission control system. Periodically

check the exhaust system for wear, exhaust leaks, and loose or missing parts. For details on how to maintain the emissions components in the exhaust system, see "Noise and Emission Control" in your vehicle operator's manual. Please refer to the engine operator's manual for more details on how to maintain the emissions components in the exhaust system.

Engine Mounting



CAUTION

DO NOT retorque or reuse existing flange head bolts. These bolts are factory set to the specified torque. If bolts are loose or damaged, they must be replaced with new bolts. Failure to comply may result in property damage.

Periodic Inspection: Inspect engine mounts every 60,000 miles (96,000 km).

Check for the following:

- Inspect both mount and leg fasteners. Check for loose or broken bolts. Replace as necessary.

- Check mount and leg for fractures, breaks or deformation. Replace as necessary.
- Check for complete insertion of motor mount. Replace as necessary.
- New leg to mount flange head bolts should be torqued to 210-230 lb-ft (284-311 N·m).

Frame



WARNING

DO NOT cut, splice, weld, or drill frame rails through the top or bottom frame rail flanges. These operations could affect frame rail strength leading to a failure resulting in an accident. Rail failures resulting from such modifications are not warrantable. Failure to comply may result in property damage, personal injury, or death.



WARNING

Frame welding is NOT recommended. The high heat of welding nullifies the special heat treatment of the rails, greatly reducing the tensile strength of the frame rail. If a frame member becomes cracked from overloading, fatigue, surface damage, or a collision, the only permanent repair is to replace the damaged frame member with a new part.

Emergency Welding

In an emergency, a temporary repair may be performed. Observe the following precautions to protect electronic systems during welding operations. Emergency welding procedures are further explained in the maintenance manuals. Please refer to the ordering information on the back cover to obtain a maintenance manual. In the event of emergency welding of a frame rail and when welding any other part of your truck or any component attached to your truck, observe the following precautions before welding:

- Disconnect all electronic devices. It is not possible to list all of the

electronics that could be affected, but a few examples include the following: alternator, engine Electronic Control Unit (ECU), transmission ECU, ABS ECU, navigation devices, diagnostic devices, and monitoring devices.

- Disconnect battery cables and insulate them from the vehicle.
- Do not use the ECU or engine ground stud for the ground of the welding probe.
- Ensure that the ground connection for the welder is as close to the weld point as possible. This ensures maximum weld current and minimum risk to damage of electrical components on the vehicle.

Painting

Do not electrostatically paint your truck or any component on your truck without first removing all of the electronic components from the truck. It is not possible to list all of the electronics that could be affected, but a few examples include the alternator, engine Electronic Control Unit (ECU), transmission ECU, ABS ECU, navigation

devices, diagnostic devices, and monitoring devices.

Fifth Wheel Monthly Maintenance

- Refer to specific manufacturer's literature for any special instructions.
- Steam clean the fifth wheel.
- Check lock guard operation using a commercial lock tester.
- Clean and oil all moving parts.
- Lubricate the lock mechanism with a lithium-base grease.
- All grease fittings (especially those which grease the top surface of the fifth wheel).

Fifth Wheel Bi-Annual Maintenance

 NOTE

Whenever possible, torque all frame fasteners on the nut end, not the bolt head.

- Refer to specific manufacturer's literature for any special instructions.

- Remove fifth wheel from vehicle. Refer to the Shop Manual, "Fifth Wheel Removal."
- Steam clean the fifth wheel and mounting brackets.
- Check all moving parts for excessive wear or damage. Replace all worn or broken parts.
- Complete two-month service procedure.
- Install fifth wheel. Refer to the Shop Manual, "Fifth Wheel Installation."

Tighten all frame fasteners with a torque wrench. See [Frame Fastener Torque Requirements](#) on page 336.

Sliding Fifth Wheels

Lubricate bearing surface of support bracket through the grease fittings on the side of the fifth wheel plate. Use a water resistant lithium-base grease.

 NOTE

The plate must be lifted up slightly to relieve the weight of the bracket while applying grease.

Fuel System

Location of Fuel Shut-off Valves

Fuel shut-off valves for the fuel crossover line are on the bottom of the secondary fuel tank, at the crossover line connection. They are optional on the primary fuel tank.

Specification

Use only diesel fuel as recommended by engine manufacturers.



WARNING

Diesel fuel in the presence of an ignition source could cause an explosion. A mixture of gasoline or alcohol with diesel fuel increases this risk of explosion. DO NOT remove a fuel tank cap near an open flame. Use only the fuel and/or additives recommended for your engine. Failure to comply may result in death, personal injury, equipment or property damage.



CAUTION

If anyone ever pours gasoline into your fuel tank, drain the entire system. Otherwise, the pump and engine will be damaged. DO NOT try to dilute the gasoline by adding diesel fuel (see Warning above).

Fuel Filters

See Engine Manufacturer's Operator Manual provided with this chassis.

Fuel Tank

Check the strap tightness. Tighten to proper torque value as required:

- Aluminum tank - 30 lb-ft (41 N·m)
- Cylindrical steel tank - 8 lb-ft (11 N·m)

Heater and Air Conditioner Maintenance

The combination heater-air conditioner provides comfort for those in the cab through accurate control of the cab

environment in all weather conditions. Regular attention to the items below will help you keep the heater-air conditioner unit running well. Keep the vehicle's ventilation system, engine exhaust system, and cab joints properly maintained. It is recommended that the vehicle's exhaust system and cab be serviced by a competent technician as follows:

- Inspected every 15,000 miles
- Whenever a change is noticed in the sound of the exhaust system
- Whenever the exhaust system, vehicle underbody, or cab is damaged

To allow for proper operation of the vehicle ventilation system, proceed as follows:

- Keep the inlet grille at the base of the windshield clear of snow, ice, leaves, and other obstructions at all times.
- Keep the exhaust pipe area clear to help reduce the buildup of exhaust gas under the vehicle.
- Check the drain tube of the fresh air inlet for trapped water before assuming that there is a leak in the heating system.

Special Precautions



WARNING

Never weld, solder, steam clean, or use a blow torch near any part of the air conditioning system. Excessive heat may cause the pressurized components of the air conditioning system to explode. Failure to comply may result in death, personal injury, equipment or property damage.



WARNING

Air conditioning refrigerant can be hazardous to your health. DO NOT expose yourself to leaking refrigerant for prolonged periods near excessive heat, open flames, or without proper ventilation. Failure to do so may result in death or personal injury.

If a refrigerant leak develops in the presence of excessive heat or an open flame, hazardous gases may be generated. If you become aware of a refrigerant leak on your vehicle have your system serviced immediately and observe the following precautions: Stay away from

the hot engine until the exhaust manifold has cooled. Do not permit any open flame in the area. Even a match or a cigarette lighter may generate a hazardous quantity of poisonous gas. Do not smoke in the area. Inhaling gaseous refrigerant through a cigarette may cause violent illness.

Heater



CAUTION

During extreme cold weather, DO NOT blow hot defroster air onto cold windshields. This could crack the glass. Turn the Air Flow Control Dial to Defrost and adjust the fan speed accordingly while the engine warms. If the engine is already warm, move the Temperature Control Dial to "cool," then gradually increase the temperature when you see that the windshield is starting to warm up. Failure to comply may result in equipment damage.

- Check all heater controls for full-range operation.
- Check hoses, connections, and heater core for condition and leaks.

Air Conditioner



WARNING

The air conditioning system is under pressure. If not handled properly during servicing, it could explode. Any servicing that requires depressurizing and recharging the air conditioning system must be conducted by a qualified technician in an approved facility. Failure to comply may result in death, personal injury, equipment damage, or property damage.



WARNING

Wear eye protection any time you use compressed air. Failure to comply may result in personal injury

- Listen to the compressor and drive clutch for noise and vibration. If you find problems, have the system checked thoroughly. A malfunctioning clutch usually indicates trouble elsewhere in the system.

- Check the evaporator core, filter, and condenser core for debris restricting air flow. Clean if necessary. Small particles may be removed with compressed air blown through the core in the opposite direction of normal air flow.
- Check the engine belt for condition and proper tension.
- Check all hoses for kinks, deterioration, chafing, and leaks. Adjust kinked or chafing hoses to eliminate restrictions and prevent further wear.
- Check all components and connections for refrigerant leaks. If you discover a leak, do not try to tighten a connection. Tightening a connection may cause a leak to worsen. Have a qualified technician correct the problem.



NOTE

A leaking evaporator or condenser core cannot be repaired; it must be replaced.

Have the air conditioning system fully serviced annually by your authorized dealer. Qualified service technicians will have to evacuate and recharge the system.

How to Replace Air Conditioner Filter

Inspect and clean cab air filter element every 3-6 months of service. Depending on the operating environment, if air flow from the air conditioner and heater is less efficient or windows fog easier, you may need to replace the cab air filter.

1. Tilt the hood open.
2. Locate air intake housing at passenger rear corner of vehicle under the rain tray.
3. Locate filter cover labeled "OPEN" with an arrow pointing rearward in vehicle. Slide filter cover rearward in vehicle until you are able to remove the cover.
4. Remove and inspect filter referring to maintenance interval schedule.
5. Replace filter in housing taking care to align the airflow direction that is indicated on the side of the side of the filter element with the airflow direction that is clearly marked on the air intake housing.

6. Replace the filter cover on the air intake housing and slide the cover forward in vehicle. An audible snap sound can be heard when the cover is correctly in place. If the snap feature is damaged there are two screw features that may be utilized to retain the cover in place.
7. Close and secure hood of vehicle.

Replace the Recirculation Air Filter

Please contact an authorized dealer when the service interval is required to inspect the cabin recirculation air filter.

Sleeper HVAC Air Filter

1. Lift the sleeper bunk to expose the sleeper HVAC module.
2. Find the retention tab at the side of the filter element and move it to release the filter. Moving this tab will allow the filter to be removed in an upward direction.
3. Align the airflow direction that is indicated on the side of the filter element such that it points into the HVAC housing.

4. Insert the filter and make sure the retention tab has re-engaged to secure the filter.
5. Close the bunk.

Lighting

How to Replace Headlight Bulbs

This procedure is for all halogen bulbs housed in the headlight assembly. Bulb replacements should be performed with the vehicle parked and the parking brake(s) set. See for correct replacement bulbs.

Access Door

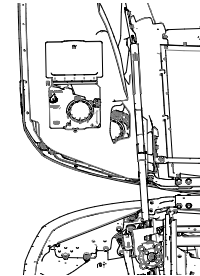

1. Park the vehicle and apply the parking brake.

2. Open the hood and secure it in the open position.
3. Locate and open the access panel on the inside of the fender liner.
4. Each bulb is removed with a counter-clockwise twist to loosen.
5. Twist and remove the socket and bulb from the headlight assembly, then replace the bulb.
6. To reinsert the bulb socket, line up the tab on the socket with the slot in the headlight housing, insert and twist clockwise to lock.
7. Replace the access panel, then close and secure the hood.

Do not touch the surface of the headlight bulb. The glass could become contaminated and cause bulb failure.



WARNING

Optional HID headlights have high voltage circuits and should only be serviced by a trained technician. Attempting to service the HID ballast without proper training may result in severe electrical shock which could lead to death or personal injury.



NOTE

LED headlights (option) are not serviceable. If you experience a LED headlight failure, contact your nearest dealer to have the problem corrected as soon as possible.

T680 Headlight Assembly

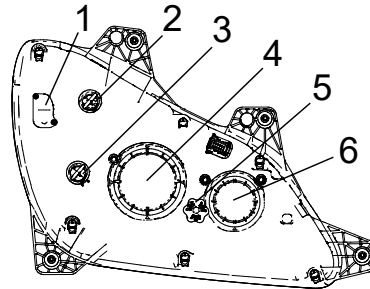

1. Side marker light
2. Turn signal
3. Daytime running light (DRL) and parking light
4. Low beam
5. Adjustment knob (Dealer use ONLY)

6. High beam

W990 & T880 Headlight Assembly

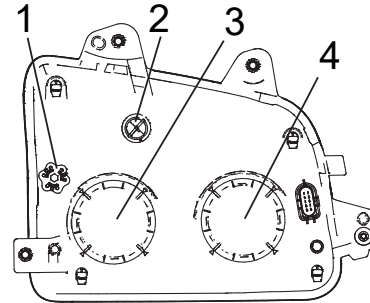

1. Adjustment knob (Dealer use ONLY)
2. Daytime running light and turn signal
3. Low beam
4. High beam

Maintaining Headlight Performance Bulb Replacement Considerations

 **NOTE**

Halogen, incandescent, and HID bulbs are brightest when they are new, and they dim over time. For optimal performance, replace your bulbs frequently. Keep a spare or lightly used bulb in the glove compartment and **never operate the vehicle with only one headlamp.**

 **WARNING**

LED replacement light sources are not approved for use in PACCAR headlamps. Using an incorrect bulb type may overheat and initiate a fire due to the headlamp's internal optics. Damage caused by the use of unauthorized LED light sources is not covered by warranty. Failure to comply may result in death, personal injury, equipment damage, or property damage.

 **NOTE**

LED headlights (option) are not user serviceable. If you experience a LED headlight failure, contact your nearest dealer to correct the problem as soon as possible.

Know your vehicle headlamp type – Standard Incandescent, Halogen, or LED. See [Light Bulb Specifications](#) on page 343 for headlight bulb replacement information.

- An unclear bulb indicates that it has overheated. It may perform poorly and/or be close to failure, and should be replaced as soon as possible.
- Bulbs should be replaced with a premium brand. Bulbs with the long life designation "LL" are recommended, but not required.
- When replacing a bulb, do not touch the globe with your fingers. Oil from human skin can focus the light locally, resulting in early bulb failure.
- If the access caps or fender liner are removed during the bulb replacement, they must be re-

installed to protect the headlight from high pressure water spray and gravel bombardment.

Lens and Body Considerations

 **CAUTION**

Do not clean the headlamp lens with solvents, abrasive brushes or substances, or petroleum products. Improper cleaning methods can break down the lens coating, which could cloud or scratch the lens. This may result in a glare that reduces headlight performance. Failure to comply may result in equipment or property damage.

- Use a soft cloth with mild, particulate free dish soap and water to clean your headlamp lenses.
- Replace your headlamp if the lens is so worn that it is not completely clear.
- A headlamp lens should only be buffed by a professional polishing service. To avoid stripping the lens of its protective coating, do not have the lens buffed more than twice in its lifetime.

- Do not hit or push on your headlamp lens, as it is only designed to withstand the force of wind.
- The headlamp assembly is equipped with filtered vents to keep out insects, allow for bulb cooling, and evacuate water vapor. Keep obstructions, or obstructing agents like mud, away from the vents. The filters are non-serviceable since the filter cap is destroyed when removed.

Alignment Considerations



WARNING

DO NOT operate the vehicle with mis-aimed headlamps. Misaimed headlamps may impact the driver's ability to see the road and other drivers. Failure to comply may result in death, personal injury, equipment damage, or property damage.



NOTE

Headlamp misalignment must be corrected by a trained technician. Please contact your nearest authorized dealership for next steps.

Headlamps are aimed according to safety standards before your truck leaves the factory. However, certain truck loads or trailer types may impact your vehicle's rake by offsetting the truck's weight distribution. This will misaim the headlamps. Some maintenance procedures can also affect headlamp alignment, such as:

- Headlamp assembly replacement
- Hood replacement

To check if your headlamps are properly aimed, park your truck on a level surface and direct the headlamps at a wall. If you notice that the focus of one light appears higher than the other, your headlamps are misaligned.

Final Checks

1. After everything is reconnected, turn on your headlights and check for operation.

2. Have your headlights periodically checked for proper alignment by dealer.
3. Keep your headlights clean, using only clean soap and water. A dirty headlight reduces performance and creates glare.

Lubricants

Schedule service more frequently if you are operating under severe conditions such as extreme heat or cold, with very heavy loads, off-road, etc. For any special service requirements, consult your service manuals and your lubricant supplier. Please remember: one key to keeping your truck running at top economy and prolonging its life is proper lubrication servicing. Neglecting this essential aspect of vehicle care can cost time and money in the long run.

 **WARNING**

Handle lubricants carefully. Vehicle lubricants (oil and grease) can be poisonous and cause sickness, personal injury, or death. They can also damage the paint on the vehicle.

 **CAUTION**

DO NOT mix different types of lubricants. Mixing lubricants (oil and grease) of different brands or types could damage vehicle components; therefore, drain (or remove) old lubricants from the unit before refilling it.

Engine

Proper engine lubrication depends on the outside temperatures where you will be driving. Use the oil recommended for the conditions you are most likely to be operating in. You will find a complete engine lubrication service guide in the Engine Operation Manual that came with your vehicle. The engine operator manual contains specific maintenance tasks that

you or a qualified service technician need to perform to maintain the engine.

 **WARNING**

Exhaust fumes from the engine contain carbon monoxide, a colorless and odorless gas. DO NOT breathe the engine exhaust gas. A poorly maintained, damaged, or corroded exhaust system can allow carbon monoxide to enter the cab. Entry of carbon monoxide into the cab is also possible from other vehicles nearby. Failure to properly maintain your vehicle could cause carbon monoxide to enter the cab, resulting in personal injury or death.

 **WARNING**

Never idle your vehicle for prolonged periods of time if you sense that exhaust fumes are entering the cab. Investigate the cause of the fumes and correct it as soon as possible. If the vehicle must be driven under these conditions, drive only with the windows open. Failure to repair the source of the exhaust fumes may result in death,

personal injury, equipment or property damage.

 **NOTE**

Keep the engine exhaust system and the vehicle's cab ventilation system properly maintained. It is recommended that the vehicle's exhaust system and cab be inspected (1) By a competent technician every 15,000 miles (24,140 km); (2) Whenever a change is noticed in the sound of the exhaust system; or (3) Whenever the exhaust system, underbody, or cab is damaged.

 **NOTE**

Use only an exact replacement DPF in exhaust systems. Using a noncompliant DPF as a replacement could violate these standards and also void the emission system's warranty.

Driveline Universal Joints

Refer to the Spicer Universal Joints and Driveshafts service manual and lubrication specifications.

Transmissions, Axles, and Hubs

See the manufacturer's operator's manual for recommended lubrication specifications and maintenance intervals.

Checking Oil Level

For oil reservoir with side filler plugs (transmission, axles, steering gear boxes, transfer cases, etc.) the oil must be level with the filler opening. Use care when checking the oil level with a finger. Just because you can reach the oil level with a finger does not mean the oil level is correct.

Improper Oil Level



Correct Oil Level



Noise and Emission Control

There are specific components on the vehicle that are designed to meet certain Environmental Protection Agency (EPA) emissions and noise regulations. To maintain conformance with the regulations, these components need to be functional and properly maintained.

Noise Emission Warranty

Kenworth warrants to the first person who purchases this vehicle for purposes other than resale and to each subsequent purchaser that this vehicle as manufactured by Kenworth, was designed, built, and equipped to conform at the time it left Kenworth's control with all applicable U.S. EPA Noise Control Regulations. This warranty covers this vehicle as designed, built, and equipped by Kenworth,

and is not limited to any particular part, component, or system of the vehicle manufactured by Kenworth. Defects in design, assembly, or in any part, component, or system of the vehicle as manufactured by Kenworth, which, at the time it left Kenworth's control, caused noise emissions to exceed Federal standards, are covered by this warranty for the life of the vehicle.

Tampering with Noise Control System

Federal law prohibits the following acts or the causing thereof:

1. The removal or rendering inoperative by any person other than for purposes of maintenance, repair, or replacement, of any device or element of design incorporated into any new vehicle for the purpose of noise control prior to its sale or delivery to the ultimate purchaser or while it is in use, or
2. The use of the vehicle after such device or element of design has been removed or rendered inoperative by any person. Among those acts presumed to constitute tampering are the acts listed below:

Air Intake System	Removing or rendering inoperative the air filter housing/silencers or intake piping
Engine Cooling System	Removing or rendering the fan clutch inoperative Removing the fan shroud
Engine	Removing or rendering engine speed governor inoperative so as to allow engine speed to exceed manufacturer's specifications Modifying ECU parameters
Exhaust System	Removing or rendering inoperative exhaust system components
Fuel System	Removing or rendering engine speed governor inoperative, allowing engine speed to exceed manufacturer's specifications Removing of air signal attenuator on engines equipped with this device Removing of diesel exhaust fluid tank and system
Inner Fender Shields and Cab Skirts	Removing shield or skirts Cutting away parts of shields, skirts or damaged or loose portions of shields or skirts
Noise Insulating Blankets	Removing noise insulators from engine block or from around the oil pan

Cutting holes in, or cutting away part of noise insulators
Removing hood-mounted noise insulation

the engine, repair that leak immediately.



CAUTION

Air leaks cause excessive noise and may result in serious damage to the engine. If you do not repair them the engine damage will not be covered by your warranty. Repair all air leaks as soon as you find them.

Inspecting Noise and Emission Components

If, during periodic inspection and maintenance of other systems and components, it is found that parts of the noise control system require attention, we recommend that those parts be inspected at more frequent intervals to assure adequate maintenance and performance. The following instructions are based on inspection of the noise control system at regular intervals as indicated in the [Noise Control System - Maintenance Log](#) on page 322.

Air Intake System

- Do all checks and maintenance procedures listed in this manual under engine air intake system and air filter housing.
- Check the induction tubing, elbow connections, clamps, brackets, and fasteners for deterioration, cracks, and security.
- If you find an air leak anywhere between the air filter housing and

Engine Mounted Noise Insulators

- Check condition. Is the insulator secure? How you do this will depend on the method of attaching the noise insulators on the engine and around the oil pan (bolts, snap fasteners, or straps). Tighten loose fasteners and repair or replace any worn or damaged fasteners.
- Check insulators around fasteners and stress points, especially where they may be affected by engine vibration. Repair any cracked or damaged mounting points. Use suitable reinforcing plates to ensure that the insulators will remain in position.

Exhaust System

- Check for exhaust leaks, which would indicate a leaking manifold gasket; replace gasket if necessary.
- Check cap screws for tightness, including those at the flanges. Refer to the engine manufacturer's service manual for proper tightening sequence and torque values.

Joins and Clamps

- Check for leaks, and tighten as necessary. Check for deterioration or dents in pipes and clamps which could allow exhaust to escape.
- Replace any serviceable joints, flexible pipes and gaskets at the service intervals.

Selective Catalysts Reduction (SCR)

- Check SCR canister filter, clamps and mounting brackets. Tighten if

necessary. Inspect SCR canister for signs of rust or corrosion.

Exhaust Piping

- Check exhaust piping for rust, corrosion, or damage. Replace deteriorated piping before holes appear. If piping is perforated at any point, temporary patching or lagging is acceptable until you can have permanent repairs made. On turbocharged engines, check joints at flanges and mounting brackets for tightness.

Diesel Particulate Filter (DPF)

- Check DPF, clamps, and mounting brackets. Tighten if necessary. Inspect DPF for signs of rust or corrosion.
- Check internal baffling. You can do this by listening for rattling sounds while tapping on the (DPF with a

rubber mallet or revving the engine up and down through its normal operating range.

DEF Tank (See Aftertreatment System manual)

Exhaust Tail Pipe

Engine Fan and Shroud

Hood Insulation Blanket

Inner Fenders Shields and Cab Skirts

Noise Control System - Maintenance Log

To ensure your vehicle's noise control requirements are maintained, record maintenance checks. Use the following log sheet and retain copies of documents regarding maintenance services performed and parts replaced on the vehicle.

Component	Recommended Interval (Miles)	Date & R.O. No.	Repair Facility & Location	Work Performed	Date & R.O. No.	Repair Facility & Location	Work Performed
Exhaust System Routing Integrity	25,000						

Component	Recommended Interval (Miles)	Date & R.O. No.	Repair Facility & Location	Work Performed	Date & R.O. No.	Repair Facility & Location	Work Performed
Shutters Shrouds	25,000						
Hood Insulation Blanket	10,000						
Engine Mounted Hose Insulators Fasteners	10,000						
Inner Fender Shields	50,000						
Cab Skirts Fasteners	50,000						
Air Intake System Integrity Element	5,000						
Clutch type Fan Drive	10,000						

Seating and Restraints

death, personal injury, equipment or property damage.

Safety Restraint System - Inspection

WARNING

Periodically inspect and maintain the safety restraint system. Safety restraint components can wear out and no longer protect the occupant in the event of an accident. Failure to comply may result in death or personal injury.

WARNING

All safety restraints and safety restraint systems on a vehicle that has been in an accident must be replaced, regardless of whether the safety restraint was in use at the time of the accident or the accident's severity. Visible and invisible damage or wear can prevent safety restraints from protecting the wearer. Failure to comply may result in

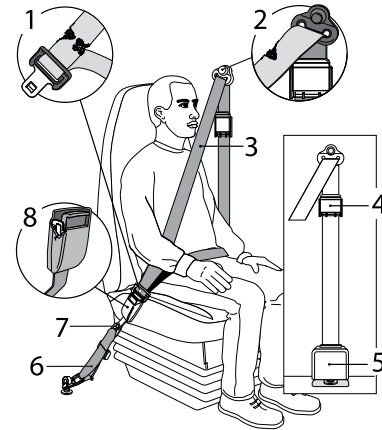

- 1. Web cut or frayed or extremely worn at latch area
- 2. Web cut or frayed at D-loop web guide
- 3. Web for deterioration, due to exposure to the sun
- 4. Comfort Clip cracked or damaged
- 5. Retractor Web Storage for damage (located behind trim panel)
- 6. Tethers for web wear and proper tightness of mounting hardware
- 7. Mounting hardware for corrosion, proper tightness of bolts and nuts
- 8. Buckle casting broken

Factors contributing to reduced seat belt life:

- Heavy trucks typically accumulate twice as many miles as the average passenger car in a given time period.
- Seat and cab movement in trucks causes almost constant movement of the belt due to ride characteristics and seat design. The constant movement of the belt inside the restraint hardware and the potential for the belt to come in contact with the cab and other vehicle parts, contributes to the wear of the entire system.

- Environmental conditions, such as dirt and ultraviolet rays from the sun, will reduce the life of the seat belt system.

Due to these factors, the three-point seat belt system installed in your vehicle requires thorough inspection every 20,000 miles (32,000 km). If the vehicle is exposed to severe environmental or working conditions, more frequent inspections may be necessary. Any seat belt system that shows cuts, fraying, extreme or unusual wear, significant discoloration due to UV (ultraviolet) exposure, abrasion to the seat belt webbing, or damage to the buckle, latch plate, retractor hardware, or any other obvious problem should be replaced immediately, regardless of mileage.

Inspection Guidelines

Follow these guidelines when inspecting for cuts, fraying, extreme or unusual wear of the webbing, and damage to the buckle, retractor, hardware, or other factors. Damage to these areas indicates that seat belt system replacement is necessary.

WARNING

Replace the entire belt system (retractor and buckle side) if replacement of any one part is necessary. Unexposed damage to one or more components could prevent the system from functioning properly the next time it is needed. Failure to comply may result in death or personal injury

- 1. Check the web wear in the system. The webbing must be closely examined to determine if it is coming into contact with any sharp or rough surfaces on the seat or other parts of the cab interior. These areas are typical places where the web will experience cutting or abrasion. Cuts, fraying, or excessive wear would indicate the need for replacement of the seat belt system.
- 2. The pillar web guide (D-loop) is the area where almost constant movement of the seat belt webbing occurs because of relative movement between the seat and cab.

3. Check the Komfort Latch for cracks or possible damage and check for proper operation.
4. Check buckle and latch for proper operation and to determine if latch plate is worn, deformed, or damaged.
5. Inspect the retractor web storage device, which is mounted on the floor of the vehicle, for damage. The retractor is the heart of the occupant restraint system and can often be damaged if abused, even unintentionally. Check operation to ensure that it is not locked up and that it spools out and retracts webbing properly.
6. If tethers are used, be sure they are properly attached to the seat and, if adjustable, that they are adjusted in accordance with installation instructions. Tethers must also be inspected for web wear and proper tightness of mounting hardware.
7. Mounting hardware should be evaluated for corrosion, and for tightness of bolts and nuts.
8. Check web in areas exposed to ultraviolet rays from the sun. If the

color of the web in these areas is gray to light brown, the physical strength of the web may have deteriorated due to exposure to the sun's ultraviolet rays. Replace the system.

Once the need for replacement of the seat belt has been determined, be certain it is only replaced with an authorized PACCAR Parts replacement seat belt. If the inspection indicates that any part of the seat belt system requires replacement, the entire system must be replaced. An installation guide is attached to every replacement belt. Utilize the proper guide for your type of seat, and follow the instructions very closely. It is vitally important that all components be reinstalled in the same position as the original components that were removed and that the fasteners be torqued to specification. This will maintain the design integrity of the mounting points for the seat belt assembly. Contact your dealer if you have any questions concerning seat belt replacement.

Steering System



WARNING

DO NOT operate the vehicle if the steering system is not working properly. You could lose control of your vehicle if the steering system is not in good working condition, which could result in a serious accident. For driving safety, visually check the steering gear and components. Frequent checks are important for driving safety, especially after traveling over rough roads. Failure to comply may result in personal injury, property damage, or death.



WARNING

Adjustments or repairs made to any part of the steering system must be performed by an authorized dealer. Failure to comply may result in property damage, personal injury, or death.

 **WARNING**

Recalibrate the steering angle sensor if this chassis is equipped with electronic stability control (ESC) and the steering angle sensor is replaced or any part of the steering system (for example, linkage, steering driveline, column, front end alignment, etc.) is repaired, removed, or disassembled. Failure to comply may result in death, personal injury, equipment damage, or property damage.

Hydraulic fluid (under low pressure) provides the power to operate the steering gear. It also serves to lubricate moving parts and remove heat. A loss of steering efficiency will occur if too much heat builds up in the system.

If the steering feels unbalanced from side-to-side while turning, check for the following possible causes:

- Unequal tire pressures
- Vehicle overloaded or unevenly distributed load
- Wheels out of alignment
- Wheel bearings improperly adjusted

If you cannot correct the problem, check with an authorized dealer. Your vehicle is equipped with integral power steering. The system includes an engine-driven fluid pump, a fluid reservoir, the steering gear, and connecting hoses. Because of the hydraulic power assist, little effort is required to turn the steering wheel. When no input is applied through the steering wheel, the steering gear will return to the neutral position. If, for any reason, the power assist system goes out, steering the vehicle is still possible but it will require much greater effort.

Visually check the following parts:

- Crosstube: Is it straight?
- Drag link castle nut: Check for looseness or interference. (Refer to [Drag Link Castle Nut Torque](#) on page 336 for specified torque).
- Ball joints and steering U-joints: Check for looseness
- Steering wheel for excessive free-play. Check the simplest probable causes first: (A) unequal tire pressures; (B) loose cap nuts; (C) bent crosstube; or (D) lack of lubrication

If these checks do not reveal the problem, or if you correct them and still have a

steering problem, take your vehicle to an authorized dealer for evaluation.

Check Power Steering Fluid Level

 **CAUTION**

When adding fluid, only use fluid of the same type. While many fluids have the same description and intended purpose, they may contain incompatible additives. Incompatible fluids may cause damage to power steering system components. Failure to comply may result in equipment or property damage.

 **NOTE**

Before removing reservoir cap, wipe the outside of the cap so that no dirt or debris falls into the reservoir.

Check the fluid level. Use the following procedure:

1. Park the vehicle on level ground and turn the engine off.
2. Open the hood.

- Check the fluid level on the reservoir.

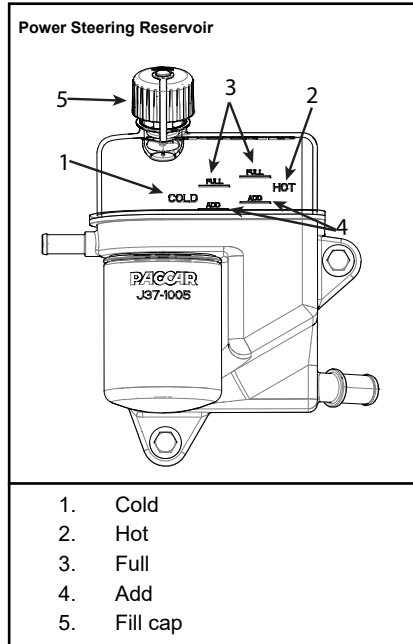

- If you check the fluid with the engine and steering system

COLD, the fluid level should be above the Add indicator level and should generally not exceed the middle point between the Add and Full level indicators.

- If you check the fluid with the engine and steering system WARM, the fluid should NOT exceed the Full level indicator and should generally not drop below the middle point between the HOT Full and Add level indicators.
- To add fluid, open the fill cap to the power steering reservoir and then add fluid until the fluid level is in the middle of the appropriate Minimum and Maximum level indicators.
 - Reinstall the reservoir fill cap and close the hood.

Steering Shaft Bolt Torque Specifications

The steering (intermediate shaft) U-joint pinch bolt should be tightened on the first day or two of operation, then checked weekly (see Weekly Checks). The following are common torque specifications for most steering shafts.

Steering U-joint Pinch Bolt

Fastener Size	Torque Spec. lb-ft (N•m)
7/16 -in.	37-43 (50-58)

Pitman Arm Clamp Bolt

Fastener Size	Torque Spec. lb-ft (N•m)
3/4 -in.	300-320 (406-433)



WARNING

If this chassis is equipped with an Electronic Stability Control (ESC) and is modified (for example, adding or removing an axle, converting from a truck to a tractor, converting from a tractor to a truck, changing the body, lengthening of the wheelbase and/or frame, relocating frame components, or modifying pneumatic or electrical ABS/ESC harnesses) the ESC must be evaluated by a qualified technician. If you have any questions, contact your authorized dealer. Failure to comply may result in death, personal injury, equipment damage, or property damage.

Tires

Your tires are a very important part of your vehicle's whole braking system. How fast you can stop depends mostly on how much friction you get between the road and your tires. Keeping your tires in good condition is essential to the safe, efficient operation

of your vehicle. Regular, frequent inspection and the right care will give you the assurance of safe and reliable tire operation. Here are some tips on maintaining your tires.

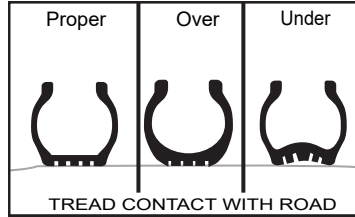

WARNING

DO NOT repair damaged tires unless you are fully qualified and equipped to do so. Wheel and tire assemblies cannot be worked on without proper tools and equipment, such as: safety cages or restraining devices. Have all tire repairs performed by an expert. Stand away from the tire assembly while the expert is working. Failure to comply may result in death, personal injury, equipment damage, or property damage.

Checking Inflation Pressure

Low pressure is a tire's worst enemy. Underinflation allows tires to flex improperly, causing high temperatures to build up. Heat causes early tire damage such as flex break, radial cracks, and ply separation. Low pressure may affect control of your vehicle, especially at the front wheels. Most tire wear problems are caused by underinflation as the result of slow leaks, so check tire pressure regularly. Lower tire pressure does not provide better traction on ice or snow. Give your tires a visual test every day, and check inflation with a gauge every week:

- When checking tire pressure, inspect each tire for damage to sidewalls, cuts, cracks, uneven wear, rocks between duals, etc. If a tire appears underinflated, check for damage to the wheel assembly. Don't forget to check between dual wheels. If you find wheel damage, have an expert tire service repair it.
- Maximum tire pressure will be indicated on the sidewall of a tire.
- Check pressure only when the tires are cool. Warm or hot tires cause pressure buildup and will give you an inaccurate reading. So never

deflate a warm tire to the specified pressure.



WARNING

DO NOT operate a vehicle with under-inflated tires. Underinflation (or low tire pressure) can create extra heat leading to sudden tire failure (such as a tire fire or blow out) or may affect control of the front wheels, both conditions possibly resulting in an accident. Keep your tires inflated to the manufacturer's recommended air pressure. Failure to comply may result in death, personal injury, equipment damage, or property damage.



WARNING

DO NOT install a damaged wheel assembly, and DO NOT install or inflate a tire that has been damaged or has been run flat. Always follow section 1910.177 of OSHA regulations. Truck wheels and tires should be serviced only by fully qualified and properly equipped technicians authorized to do so. Failure to comply may result in

death, personal injury, equipment damage, or property damage.



NOTE

Follow all warnings and cautions contained within the tire and wheel manufacturers literature.

Overloaded Tires

Overloading your truck is as damaging to your tires as underinflation. The following chart shows how neglect or deliberate abuse can affect the life of your tires.

Effects of Load and Pressure on Tire Life

Vehicle Load	Tire Pressure	Expected Total Tire Mileage
Normal	Normal	Normal
20% over	20% low	70%
40% over	30% low	50%

Vehicle Load	Tire Pressure	Expected Total Tire Mileage
60% over	35% low	40%
80% over	45% low	30%
100% over	55% low	25%

Overinflated Tires

Overinflating the tires reduces the tread contact area with the road surface, concentrating all of the vehicle weight on the center of the tread. This causes premature wear of the tire.



WARNING

Ensure all tires are inflated correctly according to the manufacturer's recommendations. Overinflated tires wear more quickly and are more subject to punctures, cracks, and other damage that can cause loss of vehicle control. Failure to comply may result in death, personal injury, equipment damage, or property damage.

Matching Tires

Be sure to buy matching tires for your vehicle, especially on the rear axles. Mismatched tires can cause stress between axles and cause the temperature of your axle lubricant to get too hot. Matched tires will help your driveline last longer and will give you better tire mileage.

 **WARNING**

DO NOT mismatch or mix tires of different design such as steel belted radials and bias ply tires, etc. Mixing tire types and sizes will adversely affect the road-holding ability of both types of tires and can lead to loss of vehicle control. Failure to comply may result in death, personal injury, equipment damage, or property damage.

 **WARNING**

DO NOT install regrooved or reinforcement repaired tires on steering axles. They could fail unexpectedly and cause loss of vehicle control. Failure to comply may result in death, personal

injury, equipment damage, or property damage.

Replacing Tires

Front: Replace front tires when less than 4/32 -in. of tread remains. Check at three places equally spaced around the tire. Drive Axles or Trailers: Replace tires on drive axles or trailers when less than 2/32 -in. of tread depth remains in any major groove. Check at three places equally spaced around the tire.

 **WARNING**

DO NOT replace original equipment tires with load ratings less than the original tires. Doing so could lead to unintentional overloading of the tire, which could cause a failure resulting in loss of vehicle control and an accident. Failure to comply may result in death, personal injury, equipment or property damage.

 **NOTE**

To prolong your tires' life, have their radial and lateral run-out checked at your dealer. Anytime a tire is replaced or reinstalled, it should be balanced.

Tire Chains

If you need tire chains, install them on both sides of each driving axle.

 **NOTE**

To prolong your tires' life, have their radial and lateral run-out checked at your dealer. Anytime a tire is replaced or reinstalled, it should be balanced.

Speed Restricted Tires



CAUTION

Check each tire's sidewall and/or tire manufacturer's data book for maximum rated speed. This vehicle is equipped with speed restricted tires and should not be operated at speeds in excess of maximum rated speed as this may cause sudden tire failure resulting in loss of control leading to an accident. Failure to comply may result in death, personal injury, equipment damage, or property damage.

Greenhouse Gas Certified Tires



NOTE

The tires installed on this vehicle at the factory as original equipment are certified for Greenhouse Gas and Fuel Efficiency regulations. Replacement tires must be of an equal or larger loaded drive tire size and an equal or lower rolling resistance level (TRRL or Crr).

Consult with your tire supplier(s) for appropriate replacement tires.

In order to limit the rolling resistance of the tires and optimize fuel economy, the maintenance procedures specified by the tire manufacturer must be followed. Please see Vehicle Emissions Limited Express Warranty for warranty on greenhouse gas certified tires.

Transmission Maintenance

See the transmission manufacturer's operator's manual for lubrication specifications and service intervals.



CAUTION

When adding oil, types and brands of oil should not be intermixed because of possible incompatibility, which could decrease the effectiveness of the lubrication or cause component failure.

Vehicles configured with the PACCAR TX-12/TX-18 or Eaton Endurant transmission must maintain the oil

coalescing desiccant cartridge of the air dryer as part of transmission maintenance.



CAUTION

Replace the oil-coalescing desiccant air dryer cartridge annually, regardless of mileage. Use only an oil-coalescing desiccant cartridge as a replacement. Failure to comply will void the transmission warranty and may cause transmission damage.

Allison Transmission Lubrication

- Refer to your transmission manual (furnished separately) for lubrication information.
- Refer to the Allison Transmission manual for servicing information.

Wheels

After the vehicle travels about 50 to 100 miles (80 to 160 km), wheel mountings seat in and will lose some initial torque. Check hub/wheel mountings after this initial period and retighten. Threads should

be clean and dry. Do not lubricate wheel nuts or studs.



WARNING

Never use oil or grease on studs or nuts; improper torque readings will result, which could cause improper wheel clamping and could lead to a wheel failure resulting in an accident. Failure to comply may result in death, personal injury, equipment or property damage.

Wheel Replacement with Disc Brake Option



WARNING

Use only the wheel brand, size and part number originally installed. Use of a different wheel brand or size could cause valve stem to interfere with a brake component which could lead to loss of vehicle control. Failure to comply may result in death, personal injury, equipment or property damage.

Vehicles equipped with front disc brakes are fitted with wheels designed specifically

for disc brake applications. If it ever becomes necessary to replace an original equipment wheel, the replacement wheel must be the same brand and size as the take-off wheel. On vehicles equipped with 22.5 in. disc wheels, installing the wrong replacement wheel could result in the wheel valve stem making contact with the disc brake assembly. When installing any replacement wheel, always inspect the tires/wheels to ensure there is adequate clearance between other vehicle components. With the hood open, check for clearance between the wheel and disc brake assembly. Use a hydraulic jack to raise the front of the vehicle off the ground to allow the wheel to spin freely. While rotating the wheel, check to ensure there is adequate clearance between the wheel and disc brake assembly.



WARNING

Improperly mounting and demounting tire and rim assemblies is dangerous. Failure to observe proper precautions could cause the tire rim assembly to burst explosively, causing death or personal injury. See the wheel manufacturer's literature for the proper way

to mount and demount your tires and rims. Follow their precautions exactly.



WARNING

Always ensure the hood lock has engaged whenever the hood is opened. Failure to lock the hood open may result in the hood closing uncontrollably, which may result in death, personal injury, equipment damage, or property damage.



WARNING

Always support the vehicle with appropriate safety stands if it is necessary to work underneath the vehicle. A jack is not adequate for this purpose. Failure to comply may result in death, personal injury, equipment or property damage.

Disc Wheels



WARNING

Use the correct components and tools when working on wheels. Grooves in the wheel disc or other damage to the disc can weaken the wheel and cause it to eventually come off. This could cause you to lose control of your vehicle, and may result in an accident. Failure to comply may result in property damage, personal injury, or death.

The end of the wheel wrench must be smooth. Burrs on the end of the wrench can tear grooves in the disc. These grooves may lead to cracks in the disc, and can cause it to fail.

Wheel Bearings

Service the bearings, seals and oil. This interval may be different depending on the results of the regular inspection. 350,000 mi (560,000 km). For safe, reliable operation and adequate service life, your wheel bearings must be adjusted properly at the recommended intervals. Contact your authorized dealer to make sure the wheel bearings are properly adjusted.

Tightening Wheel Cap Nuts



WARNING

Tighten wheel cap nuts properly. If they are not tightened properly, wheel nuts could eventually cause the wheel to become loose, to fail, and/or to come off while the vehicle is moving, possibly causing loss of control and may result in death, personal injury, equipment or property damage.

Hub Piloted Disc Wheels

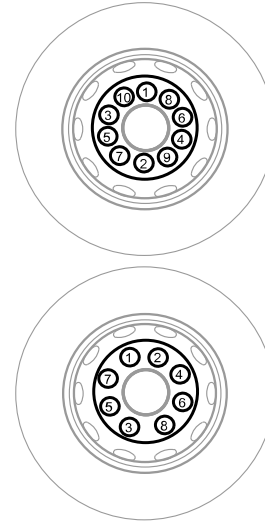

Proper wheel torque can best be obtained on level ground. Install lug nuts and finger-tighten in the numerical sequence as shown below. This procedure will ensure that the wheel is drawn evenly against the hub. Contact an authorized dealer for information on the proper installation procedure for the wheels on your truck.

This is a job you may not be able to do yourself. You need the right torquing equipment to do it.

Stud Piloted Disc Wheels

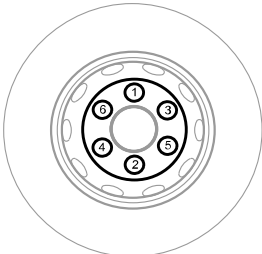
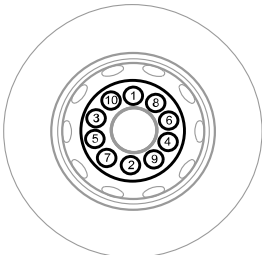

Windshield Wiper/Washer

The windshield wiper system is designed to be maintenance-free. Check wiper blades annually, every 60,000 miles (96,000 km), or when they begin to show signs of wear. Check the washer reservoir water level daily, located in the engine compartment. If necessary, refill to the proper level.

How to Refill the Washer Fluid Reservoir

	CAUTION
DO NOT use antifreeze or coolant in the windshield washer reservoir. These are harmful fluids to the seals and other components. Failure to comply may result in equipment or property damage.	

1. Park the vehicle and apply the parking brake.
2. Open the hood and secure it in the open position.
3. Locate the washer fluid reservoir and open the filler cap. It will be located in one of two places:
 1. Passenger side (RH) in front of the steer tire - 2.4 Gallons (9 Liters) capacity
 2. Drivers side (LH) on top of the radiator - 2.0 Gallons (7.6 Liters) capacity
4. Fill the reservoir with windshield washer fluid and replace the cap
5. Close and secure the hood.

Specification Reference Charts

Pipe and Hose Clamp Torque Values

Torque specifications for engine parts.

Application	Type of Clamp	lb-in.	N·m
Radiator and Heat Exchanger Hoses	Constant Torque CT-L	90-110	10.2-12.5
Heater Hoses	Constant Tension	not required	not required
Air Intake Pipes	Hi Torque HTM-L	100-125	11.3-14.2
Plastic Air Intake Pipes	Constant Torque CT-L	88	10.0
Charge Air Intake Hoses	Flex Seal	70-100	7.9-11.3
	B9296	50-60	6-7
Fuel, Oil and Water Heat Exchangers (for hoses less than 9/16 in. diameter).	Miniature 3600L	10-15	1.1-1.7

Drag Link Castle Nut Torque

Ball Stud Fastener	Castle Nut Torque lb·ft (N·m)
7/8-14	120 to 170 (163 to 231)

Frame Fastener Torque Requirements



CAUTION

When torquing fasteners, always consider the following:

- Use a torque wrench for final tightening of these fasteners. Do not use an impact gun. These

bolts may over-torque and break.

- When torquing, the nut must rotate slightly before achieving the torque value. If the nut does not rotate, the fastener is over-torqued and should be replaced.
- To achieve correct clamp loads, the frame fasteners must be torqued with the nut. The intended

clamp load may not be achieved if the nut is held and torque is applied to the bolt.

Incorrectly tightening the fasteners may result in clamp load or frame failures. Failure to comply may result in equipment or property damage.

*Consult manufacturer or lubricant supplier for special details.

Lubrication Specification Chart

 **NOTE**

The responsibility for meeting these specifications, the quality of the product, and its performance in service rests with the lubricant supplier.

Component Lubrication Index

Application	Type
Steering Column	Multipurpose chassis grease
Alternator Bearing	High temperature ball bearing grease. Chevron SRI Mobile Grease HP, Texaco Multifax 2 (1)
Fan Hub	High temperature ball bearing grease. Chevron SRI Mobile Grease HP, Texaco Multifax 2 (1)

Application	Type
Power Steering Reservoir	MD3 or MERCON®-approved automatic transmission fluid
Steering Drag Link	Multipurpose chassis grease
Steering Knuckles	Multipurpose chassis grease
Spring Pins	Multipurpose chassis grease
Clutch Release Bearings	High temperature ball bearing grease. Chevron SRI Mobile Grease HP, Texaco Multifax 2
Brake Shoe Anchor Pins	High Temperature grease (Timken Spec. 0-616)
Brake Cam Bearings	High Temperature grease (Timken Spec. 0-616)
Slack Adjusters	Multipurpose chassis grease
Starter Bearings	Engine oil for severe requirements (MIL-L-2104B /MIL-L-45199B) w/ 1.85 % max. sulfated ash
Water Pump	High temperature ball bearing grease. Chevron SRI Mobile Grease HP, Texaco Multifax 2 (1)
Suspension Fittings (other than threaded pins and bushings)	Extreme Pressure Lubricant (Lithium 12-hydroxystearate base NLGI 2)
Steering Axle: Grease Fittings on Steering Arm; Tie Rod Ends; Drag Link; King Pins	Extreme Pressure Lubricant (Lithium 12-hydroxystearate base NLGI 2)
Steering Shaft Grease Fittings	Extreme Pressure Lubricant (Lithium 12-hydroxystearate base NLGI 2)

Application	Type
Brake Treadle Hinge and Roller	Engine oil
Lock Cylinders	Lock lubricant
Door Hinges	Do not lubricate
Door Latches and Striker Plates	Polyethylene grease stick
Door Weatherstrip	Silicone lubricant
Hub-piloted Aluminum Wheels	Coat the wheel pilot or hub pads with Freylube #3 lubricant (light colored) or Chevron Zinc lube. Do not get lubricant on the face of the wheel or the hub.
Manual Transmission Hydraulic Clutch	DOT3 (Brake Fluid)
(1) Consult manufacturer or lubricant supplier for special details.	

Suspension U-Bolts, Class 10.9

Tighten all U-bolts with a torque wrench. U-bolt torque requirements in the table below apply to PACCAR proprietary suspensions using clean, lightly lubricated (Chevron Zinc Lubricant or SAE 20/30 oil) threads only. For all other suspensions, follow the manufacturer's recommended torque values. PACCAR proprietary suspension U-bolts must be tightened in a specific sequence. Take your vehicle to an authorized dealer to tighten the U-bolts on your vehicle.

Fastener Torque for Class 10.9 U-Bolts

Front Suspension U-bolts		
U-Bolt Diameter (- in.)	Torque (lb-ft)	Torque (N•m)
3/4	275–320	373–434
7/8	370–415	502–563

Front Suspension U-bolts		
U-Bolt Diameter (- in.)	Torque (lb-ft)	Torque (N•m)
For all non-PACCAR suspension systems, see the manufacturer's operator's manual for torque specifications.		

Rear Suspension U-bolts		
Suspension Type	U-Bolt Diameter	Torque lb-ft (N•m) ²⁹
AG210L (U-bolt, spring)	M22 x 1.5	375–475 (508–644)
AG380	M22 x 1.5	325–375 (440–508)
AG400L (U-bolt, spring)	M22 x 1.5	375–475 (508–644)
TL135 (Axle U-bolt)	¾ -in. 16 UNF	275–320 (373–434)
TL180 (Axle U-bolt)	¾ -in. 16 UNF	275–320 (373–434)
AG180 (Axle U-bolt)	¾ -in. 16 UNF	275–320 (373–434)
For all non-PACCAR suspension systems, see the manufacturer's		

Rear Suspension U-bolts		
Suspension Type	U-Bolt Diameter	Torque lb-ft (N•m)
operator's manual for torque specifications.		

 **NOTE**
The values shown here are for suspension U-bolts and should not be applied to bolts and fasteners for the frame.

Rear Suspension Fasteners

Air-Trac Fastener Torque Values

Fastener	Fastener Name	lb•ft (N•m)
M16	Tracking rod bolts	125–165 (170–224)
0.75 NF	Spring center bolt	165–210 (224–285) ³⁰
M16 0.75 NF	Radius rod bolts (forward)	155–195 (210–264)
	Radius rod bolts (at axle)	250–350 (339–475)
M16	Frame bracket bushing bolts	50–65 (68–88)

²⁹

Torques listed are for non-primed (oiled) U-bolts on KW AG210L and AG400L suspensions.

³⁰

Torque requirement applies at sub-assembly of air-spring support and leaf spring only.

Fastener	Fastener Name	lb•ft (N•m)
1.0 NF	U-bolt ³¹	Refer to section on Suspension U-Bolts, Grade 8.
0.5 UNC	Air bag stud nut	40–50 (54–68)
M16	Tracking rod bolts	125–165 (170–224)

Fastener	Fastener Name	Torque lb•ft (N•m)
M22 x 1.5	U-bolt, spring ³²	Refer to section on Suspension U-Bolts, Class 10.9.
0.5 UNC	Air bag stud nut	40–50 (54–68)
M16	Tracking rod bolts	125–165 (210–264)

Fastener	Fastener Name	Torque lb•ft (N•m)
		U-Bolts, Class 10.9.
0.5 UNC	Air bag stud nut	40–50 (54–68)
M16	Tracking rod bolts	125–165 (210–264)

Low Air Leaf Torque Values

Low Air Leaf Torque values apply to both single and tandem axles.

Fastener	Fastener Name	Torque lb•ft (N•m)
M20 x 2.5	Bar pin bolts	325–425 (441–576)

Fastener	Fastener Name	Torque lb•ft (N•m)
M20 x 2.5	Bar pin bolts	325–425 (441–576)
M22 x 1.5	U-bolt, spring ³³	Refer to section on Suspension

³¹ See owners manual for torque tightening sequence.
³² Contact your dealer for torque tightening procedure.
³³ Contact your dealer for torque tightening procedure.

Flex Air Fastener Torque Values

Fastener	Fastener Name	Torque lb-ft (N•m)
M16	Drive bracket - frame bolts	125–165 (170–224)
	Drive bracket - link spring bolt	
	Drive bracket - radius rod bolt	
	Drive beam - shock bolt (lower)	
	Shock bracket - shock bolt (upper)	

Fastener	Fastener Name	Torque lb-ft (N•m)
	Tracking rod bolts (all)	
M10	Air spring support beam bolts	36–51 (49–69)
0.88 - 14 UNF	Drive beam - link spring bolt	380–460 (515–624)
0.88 - 14 UNF	Radius rod bracket bolt	380–460 (515–624)
M22 x 1.5	U-bolt ³⁴	Refer to section on Suspension U-Bolts, Class 10.9.
0.5 UNC	Air bag stud nut	40–50 (54–68)

Fastener	Fastener Name	Torque lb-ft (N•m)
M16	Drive bracket - frame bolts	125–165 (170–224)
	Drive bracket - link spring bolt	
	Drive bracket - radius rod bolt	
	Drive beam - shock bolt (lower)	
	Shock bracket - shock bolt (upper)	
	Tracking rod bolts (all)	

³⁴ Contact your dealer for torque tightening procedure.

Fastener	Fastener Name	Torque lb-ft (N•m)
M10	Air spring support beam bolts	36–51 (49–69)
0.88 - 14 UNF	Drive beam - link spring bolt	380–460 (515–624)
0.88 - 14 UNF	Radius rod bracket bolt	380–460 (515–624)
M22 x 1.5	U-bolt ³⁵	Refer to section on Suspension U-Bolts, Class 10.9.
0.5 UNC	Air bag stud nut	40–50 (54–68)

Light Bulb Specifications

Bulb Location	Type of Bulb	Notes
Low beam halogen	H11-LL (SAE), H7 (ECE)	(Long life version not required)
Low beam LED	N/A	Non-serviceable
Low beam HID	D1-S	
High beam halogen	HB3A – LL	(Long life version not required)
High beam LED	N/A	Non-serviceable
Daytime running lamp/ position lamp/turn signal/	4157K (SAE), 3157K (ECE)	N/A

Bulb Location	Type of Bulb	Notes
halogen side marker lamp		
LED Side marker	N/A	LED
Rear tail lamp/turn signal	N/A	LED
Interior map/ dome/indirect light	N/A	LED

Wheel Cap Nut Torque Specifications

At the first scheduled lube interval, have all wheel cap nuts torqued to their specified value. After that, check wheel cap nuts at least once a week. Contact an authorized dealer for information on the proper installation procedure for the wheels on your vehicle. This is a job you may not be able to do yourself. You need the right torquing equipment to do it.

35

Contact your dealer for torque tightening procedure.

Wheel and Nut Configuration	Stud Size	Torque for Two Piece Flanged Cap Nuts	
		lb-ft	N•m
Hub-Piloted Disc-Type Wheel w/Two Piece Flanged Cap Nuts: Steel or Aluminum Wheel PHP-10; Budd Uni-Mount-10; WDH-8	M22-1.5	450-500	610-680
Stud Backnuts (when used)	3/4-16	175-200	240-270
	1-14	175-300	240-410
Cast Spoke Wheel Assembly Rim Clamp Nut Torque	1/2 in. Dia.	80-90	110-120
	5/8 in. Dia.	160-185	220-250
	3/4 in. Dia.	225-245	305-335

Over-the-Air (OTA) Software Updates

When OTA system updates are available for selected Electronic Control Units (ECU), a message appears on the digital display. To install the updates, use the Steering Wheel Control pad.



WARNING

Performing an over-the-air (OTA) update has the potential to render the vehicle inoperable. Perform the OTA only in a safe location. Failure to comply can result in death, personal injury, equipment or property damage.

- Find a safe location preferably in a town or city
- Stop the truck
- Set the parking brake
- Switch off the engine
- Place the key in the ON position
- The 12 V battery must show as "OK"

Before you begin:

**CAUTION**

Follow all instructions to prevent the vehicle from becoming inoperable. Avoid high electrical power draw by other vehicle systems while performing the update.

Using the Steering Wheel Control pad:

1. Select "Menu."
2. Select "Settings."
3. Select "Start Installation."
 - The message "System Update In Progress" appears.
 - If successful, "System Update Complete" appears.
4. Turn the key to the OFF position to exit updates.

**NOTE**

If the restore *fails*, "System Restore Failed" appears. **At this point, it is possible that the vehicle is inoperable.** The instructions now direct the driver to seek service immediately.

(See [Roadside Assistance](#) on page 41).

- If *unsuccessful*, "System Update Failed" appears AND the system automatically starts restoring the previous software version. A message appears to inform the operator of the start of the restoration process.
- If the system restore succeeds, "System Restored" appears.

Chapter 6 | INFORMATION

Consumer Information.....	347
Vehicle Identification Labels.....	347
Clean Idle.....	350
Greenhouse Gas Certified Configuration.....	351
Vehicle Emissions Limited Express Warranty.....	354
Telematics Control Unit FCC Information.....	357

Consumer Information

How To Order Replacement Parts

You can obtain replacement parts from an authorized dealership. When you order, it is **IMPORTANT** that you have the following information ready:

- Name and address
- Serial number of the vehicle
- The name of the part you need
- The name and number of the component for which the part is required
- The quantity (qty) of parts you need
- How you want the order shipped

National Highway Traffic and Safety Administration (NHTSA)

If you believe that the vehicle has a dangerous defect, you must immediately inform the National Highway Traffic Safety Administration (NHTSA). Also notify the vehicle manufacturer. If NHTSA receives similar complaints, it can open an investigation. If it finds that a safety defect exists in a group of vehicles, it can order a recall and remedy campaign. However,

NHTSA cannot get involved in individual problems between you, the dealer, and the vehicle manufacturer. Contacting NHTSA is possible through telephone, written mail, and email. NHTSA also has a website where you can input the comments directly to them on the Web. Use any of the four ways to contact NHTSA:

Ex: Toll Free 1-888-327-4236
(800-424-9153 TTY) 8:00 a.m. to 10:00 p.m. EST Monday-Friday

Mail: Office of Defects
Investigations/CRD NVS-216 1200 New
Jersey Ave. SE Washington, D.C. 20590

Website: www.safercar.gov

Email: nhtsa.webmaster@dot.gov

Transport Canada

Canadian customers must report a safety-related defect to Transport Canada, Defect Investigations and Recalls. You can reach them by telephone on the toll-free hotline at 1-800-333-0510. You can also contact Transport Canada by mail at:

Transport Canada, ASFAD Place de Ville
Tower C 330 Sparks St. Ottawa, ON K1A
0N5

For additional road safety information, visit the Road Safety website at:
<http://www.tc.gc.ca>

Vehicle Identification Labels

Each vehicle completed by Kenworth Truck Company uses a vehicle identification number (VIN) that contains the model year designation of your vehicle. The practice is in compliance with 49 CFR 565, Code of Federal Regulations.

The full, 17-digit VIN is located on the Weight Rating Data Label. The label is located on the driver's side door edge or on the driver's side door frame.

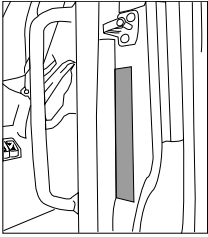

- Back of cab, left-hand rear panel, lower edge
- Tire, Rim, and Weight Rating Data label (truck)
- Components and Weights label
- Noise Emission label
- Paint Identification label

Certification Labels

Your vehicle information and specifications are documented on labels. As noted below, each label contains specific information pertaining to vehicle capacities and specifications that you should be aware of.

Components and Chassis Weight Label

The Components and Chassis Weight Label is located on either the driver's side door edge or on the driver's side door frame. It includes chassis number, chassis weight and gross weight, plus model information for the vehicle, engine, transmission, and axles.

Tire, Rim and Weight Rating Data Label

The Tire, Rim, and Weight Rating Data Label is located on the driver's side door

edge or on the driver's side door frame. It contains the following information:

- GVWR - Gross Vehicle Weight Rating
- GAWR FRONT, INTERMEDIATE and REAR - Gross Axle Weight Ratings for Front, Intermediate and Rear Axle
- TIRE/RIM SIZES AND INFLATION PRESSURES - Tire/Rim Sizes and Cold Pressure Minimums
- VIN including CHASSIS NUMBER

The components of your vehicle are designed to provide satisfactory service, if the vehicle is not loaded in excess of either the gross vehicle weight rating (GVWR), or the maximum front and rear gross axle weight ratings (GAWRs).

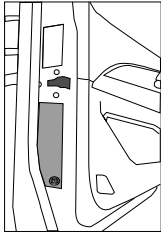

Chassis Number

The Chassis Number refers to the last six characters of the VIN. This number will allow your dealer to identify your vehicle. You will be asked for this number when you bring it in for service. Chassis Number Locations:

- Right frame rail, top flange, about 3 ft. from the front end

 **WARNING**

DO NOT exceed the specified load rating. Overloading can result in loss of vehicle control, either by causing component failures or by affecting vehicle handling. Exceeding load ratings can also shorten the service life of the vehicle. Failure to comply may result in death, personal injury, equipment damage, or property damage.

 **NOTE**

GVW is the TOTAL SCALE WEIGHT the vehicle is designed to carry. This

includes the weight of the empty vehicle, loading platform, occupants, fuel, and any load.

Noise Emission Label

The Noise Emission Label is located in the driver's side door frame. It contains information regarding U.S. noise emission regulations, chassis number, and date of manufacture.

Paint Identification Label

The Paint Identification Label contains the paint colors used by the factory to paint your vehicle. It lists frame, wheels, cab interior and exterior colors. This label is located inside the glove box.

Federal Safety Standard Certification Label

The NHTSA regulations require a label certifying compliance with Federal Safety Standards, for United States and U.S. Territories, be affixed to each motor vehicle and prescribe where such label may be located. This certification label, which indicates the date of manufacture and other pertinent information, is located on the driver's side door edge or on the driver's side door frame.

Component Identification

Each of the major components on your vehicle has an identification label or tag. For easy reference, record component numbers such as, model, serial, and assembly number.

Engine	For further information, please refer to the Engine Operation and Maintenance Manual.
Transmission	For both manual and automatic transmissions, the identification number is stamped on a tag affixed to the right rear side of the transmission case.
Clutch	Enclosed in clutch housing. Location depends on manufacturer.
Steer Axle	The front axle serial number is stamped on a plate located on the center of the axle beam.
Axle Specification Number	Usually stamped on the right rear side of the axle housing. This number identifies the complete axle.

Axle Housing Number	Usually located on the left forward side of the housing arm. This tag identifies the axle housing.
Axle Differential Carrier Identification	Usually located on the top side of the differential carrier. The following information is either stamped, or marked with a metal tag: Model No., Production Assembly No., Serial No., Gear Ratio, and Part Number.

Clean Idle

To comply with CARB or EPA emissions requirements, the vehicle must have the Certified Clean Idle label. Some vehicles, however, are exempt from these requirements because of their configurations (for example: fire truck service).

The vehicle could display any of these labels. When present, they display prominently that its engine meets the strict low exhaust emission regulations instituted by CARB or EPA. It is important that you do not remove or deface this label. Do not block it from view. Contact the authorized dealership to see if you can replace the label. The dealership helps you to determine whether or not the vehicle's engine is a candidate for a Certified Clean Idle label. Certain vehicles that did not ship with the label are still eligible to display one.

A PACCAR engine label looks like one of the images below.



If you have a Cummins engine, the label looks like one or both of the images below.



Engine Shutdown System (ESS)

To meet CARB certification, the engine must have an ESS. An ESS provides both the "limited idle" and "low exhaust emissions" standards required by CARB (and some additional states.) These

regulations require that the engine comes with an automatic system to restrict the idle time on certain vehicles, under certain circumstances. If so equipped, the ESS shuts off the engine when:

- the vehicle idles for more than 5 minutes with the parking brake set and the transmission is in "Neutral" or "Park"

The shutoff timer extends to 15 minutes with the parking brake OFF. If the engine is in one of the following states, the ESS does NOT shut down the engine:

- operating in Power Take Off (PTO) mode
- when the engine coolant is below 60 degrees Fahrenheit
- while performing a regeneration while parked

When the ESS shutdown timer reaches the last 30 seconds, the check engine light alerts the driver. During these 30 seconds, it is possible to reset the idle time by pressing on the accelerator pedal. These 30 seconds are the ONLY time that it is possible for the driver to reset the idle time using this method. More detailed information is available in the Engine Operator's Manual provided with the vehicle.

Greenhouse Gas Certified Configuration

This vehicle includes Greenhouse Gas (GHG) regulated parameters and technologies. A Vehicle Emission Control Information label is located on the driver's door with codes that partially identify the vehicle's GHG certified configuration. In addition to the Vehicle Emission Control Information label, other technologies that reduce GHG emissions and regulated parameters included in the vehicle's GHG certified configuration are described in this section.

	NOTE
<p>Modifying a vehicle's certified configuration without good engineering judgment or PACCAR's approval may be a violation of the Clean Air Act and subject to fines and penalties. Please contact the vehicle manufacturer for further information about this vehicle's certified configuration.</p>	

Vehicle Emission Control Information Label Descriptions

Label Identifiers	Label Identifier Descriptions
Family Name	Describes the vehicle's certified manufacturer, regulatory category, and regulatory subcategory
Emission Controls	Describes regulated emission control devices installed on the vehicle
Compliance Statement	Describes the vehicle's compliance standards
Regulatory Subcategory	Describes the vehicle's certified regulatory subcategory

Emission Controls	Emission Control Descriptions
ARF	Aerodynamic roof fairing
ARFR	Adjustable height aerodynamic roof fairing
ATS	Aerodynamic side skirt and/or fuel tank fairing
AFF	Aerodynamic front fairing
AREF	Aerodynamic rear fairing
TGR	Gap reducing fairing
LRRR	Low rolling resistance tires (all)
LRRD	Low rolling resistance tires (drive)
LRRS	Low rolling resistance tires (steer)

VSL	Vehicle speed limiter
VSLs	Soft-top vehicle speed limiter
VSLE	Expiring vehicle speed limiter
VSLD	Vehicle speed limiter with both soft-top and expiration
IRT	Engine shutoff system
IRT5	Engine shutoff after 5 minutes or less of idling
IRTE	Expiring engine shutoff
ADVH	Vehicle includes advanced hybrid technology components
ADVO	Vehicle includes other advanced-technology components

INV	Vehicle includes innovative (off-cycle) technology
ATI	Automatic tire inflation system
TPMS	Tire pressure monitoring system

GHG Regulated Technology Not On the Emission Control Information Label

Technology	Compliance Requirements
-------------------	--------------------------------

Wheel-Related Weight Reduction	Wheel-related weight reduction benefits may be included in this vehicle's certified configuration. Changing aluminum wheels to steel wheels may be a violation of the Clean Air Act and subject to fines and penalties.
Non wheel-Related Weight Reduction	Non wheel-related weight reduction benefits may be included in this vehicle's certified configuration. Changing aluminum material to steel material may be a violation of the Clean Air Act and subject to fines and penalties.
Other Technologies	This vehicle may be equipped with factory installed

automatic engine shutdown (AES), neutral idle, start-stop systems, intelligent controls (Predictive Cruise Control and Neutral Coast), or extended idle reduction systems (Engine Idle Shutdown Timer, Engine Auto Start, Sleeper APUs, Fuel-Fired Sleeper Heater System). Disabling or modifying any GHG regulated technology may be a violation of the Clean Air Act and subject to fines and penalties.

GHG Regulated Powertrain Parameters Not On the Emission Control Information Label

Powertrain Components	Regulated Parameters
Engine	Engine idle speed, torque, horsepower, and governed RPM
Transmission	Lock up gear, number of gears, and torque converter
Axle	Configuration and drive axle ratio

GHG Regulated Aerodynamic Performance

The vehicle needs to stay in as-built aerodynamic performance unless good engineering judgment shows that the modification will improve safety or will not increase greenhouse gases.

GHG Regulated Certified Tires



The tires installed on this vehicle at the factory as original equipment are certified for Greenhouse Gas and Fuel Efficiency regulations. Replacement tires must be of an equal or larger loaded drive tire size and an equal or lower rolling resistance level (TRRL or Crr). Consult with your tire supplier(s) for appropriate replacement tires.

In order to limit the rolling resistance of the tires and optimize fuel economy, the maintenance procedures specified by the tire manufacturer must be followed. Please see Vehicle Emissions Limited Express Warranty for warranty on greenhouse gas certified tires.

GHG Regulated Air Conditioning Leakage Standards

Loss of refrigerant from the air conditioning systems may not exceed a total leakage rate of 11.0 grams per year or a percent leakage rate of 1.50 percent per year, whichever is greater. This vehicle was built to meet these air conditioning leakage

standards. Any modification of the air conditioning system must comply with leakage rates defined in SAE J2727.



Modifying a vehicle's certified configuration without good engineering judgment or PACCAR's approval may be a violation of the Clean Air Act and subject to fines and penalties. Please contact the vehicle manufacturer for further information about this vehicle's certified configuration.

Vehicle Emissions Limited Express Warranty

Original Equipment Tires

PACCAR Inc. warrants the tires installed as original equipment on this vehicle only against defects in materials and workmanship which cause the vehicle to fail to comply with applicable U.S. and Canadian greenhouse gas emission limits ("Warrantable Emissions Failures"). This vehicle emissions limited express warranty relating to original equipment tires is valid

for two (2) years or 24,000 miles (38,000 km), whichever occurs first. YOUR SOLE AND EXCLUSIVE REMEDY AGAINST PACCAR Inc. IS LIMITED TO THE REPAIR OR REPLACEMENT OF ORIGINAL EQUIPMENT TIRES, SUBJECT TO PACCAR'S TIME AND MILEAGE LIMITATIONS LISTED ABOVE. This Vehicle Emissions Limited Express Warranty relating to original equipment tires begins on the date of delivery of the vehicle to the first purchaser or lessee and accrued time and mileage is calculated when the vehicle is brought in for correction of the Warrantable Emissions Failures relating to the original equipment tires. PACCAR MAKES NO OTHER VEHICLE EMISSIONS WARRANTIES RELATING TO THE ORIGINAL EQUIPMENT TIRES, EXPRESS OR IMPLIED. WHERE PERMITTED BY LAW, PACCAR EXPRESSLY DISCLAIMS ANY WARRANTY OF MERCHANTABILITY OR FITNESS FOR A PARTICULAR PURPOSE RELATING TO VEHICLE EMISSIONS. PACCAR AND THE SELLING DEALER SHALL NOT BE LIABLE FOR INCIDENTAL OR CONSEQUENTIAL DAMAGES INCLUDING, BUT NOT LIMITED TO: LOSS OF INCOME OR LOST PROFITS;

VEHICLE DOWNTIME; COMMUNICATION EXPENSES; LODGING AND/OR MEAL EXPENSES; FINES; APPLICABLE TAXES OR BUSINESS COSTS OR LOSSES; ATTORNEY'S FEES; AND ANY LIABILITY YOU MAY HAVE IN RESPECT TO ANY OTHER PERSON OR ENTITY RELATING TO WARRANTABLE EMISSIONS FAILURES. This Vehicle Emissions Limited Express Warranty relating to original equipment tires is limited to emissions compliance only. The tires are separately warranted by their manufacturer for defects in materials and workmanship other than those which cause non-compliance with U.S. and Canadian GHG regulations, subject to limitations and conditions contained within the tire manufacturer's warranty agreement. You are responsible for the safe operation and maintenance of the vehicle and its tires. PACCAR does not warrant wear and tear of the tires.

Greenhouse Gas (GHG) Components Other Than Tires

This GHG vehicle Warranty applies to the vehicle (hereafter, vehicle) certified with the US Environmental Protection Agency.

Your Warranty Rights and Obligations

This vehicle is warranted for components that directly impact the manufacturers GHG certification with the US Environmental Protection Agency. PACCAR must warrant these components for the periods of time listed below provided there has been no abuse, neglect or improper maintenance of the vehicle. If a GHG-related part on your vehicle is found to have a defect in material or assembly, the part will be repaired or replaced by PACCAR.

Manufacturer's Warranty Coverage

This emissions warranty coverage is provided for five years or 100,000 miles (160,000 km), whichever occurs first, from the date of delivery of the vehicle to the first purchaser or first lessee. Where a Warrantable Condition exists, PACCAR will diagnose and repair the vehicle, parts and labor included, at no cost to the first purchaser or first lessee and each subsequent purchaser or lessee. This warranty does not override any extended warranty purchased to cover specific vehicle components.

Owner's Warranty Responsibilities

The vehicle owner is responsible for performing required maintenance that is listed in your engine and vehicle Operator's Manuals. The owner is responsible for presenting the vehicle to a service location as soon as a problem exists. Any warranty repairs should be completed in a reasonable amount of time. Retain all receipts covering maintenance on this equipment. PACCAR cannot deny warranty solely for the lack of receipts or for the failure to ensure the performance of all scheduled maintenance. PACCAR may deny warranty coverage if a vehicle component has failed due to abuse, neglect, improper maintenance, unapproved modifications (both physical components and computer programming) or using non-Original Equipment replacement parts. If there are any questions regarding these warranty rights and responsibilities, please contact the vehicle OEM manufacturer at the customer center telephone number provided with the vehicle operating instructions. Prior to the expiration of the applicable warranty, Owner must give notice of any warranted failure to an authorized PACCAR dealer and deliver the vehicle to such facility for repair. Owner is responsible for incidental

costs such as: communication expenses, meals, lodging incurred by Owner or employees of Owner as a result of a Warrantable Condition. Owner is responsible for downtime expenses, cargo damage, fines, all applicable taxes, all business costs, and other losses resulting from a Warrantable Condition. Owner is responsible for maintaining all emissions related engine and vehicle computer program settings in accordance with manufacturer specifications. This responsibility includes GHG specific settings that may not be altered before the GHG-related expiration mileage has been reached for each system. Owner is responsible for maintaining all physical parts related to GHG-regulations in the as-built configuration and in proper working order for the full regulatory useful life of 435,000 miles (700,000 km) or 10 years for Class 8 vehicles, 185,000 miles (300,000 km) or 10 years for Class 5-7.

Replacement Parts

PACCAR recommends that any service parts used for maintenance, repair or replacement of GHG components be new or genuine approved rebuilt parts and assemblies. The use of non-genuine engine or vehicle replacement parts that

are not equivalent to the PACCAR engine or OEM vehicle manufacturer's original part specification as built from the factory may impair the engine and vehicle emissions control system from working or functioning effectively, and may jeopardize your GHG warranty coverage. In addition, genuine vehicle or engine parts must be replaced with the same material and function as the part assembled on the vehicle from the factory. The owner may elect to have maintenance, replacement or repair of the emission control parts performed by a facility other than an authorized PACCAR dealer and may elect to use parts other than new or genuine approved rebuilt parts and assemblies for such maintenance, replacement or repair; however, the cost of such service or parts and subsequent failures resulting from such service or parts may not be fully warranted if the manufacturer determines that the replacement part is not of similar material and function as the OEM part assembled to the vehicle at the factory.

PACCAR Responsibilities

The warranty coverage begins when the vehicle is delivered to the first purchaser or first lessee. Repairs and service performed by any authorized PACCAR dealer using

new or genuine approved rebuilt parts and assemblies will utilize replacement parts that are selected and installed to support the GHG compliance certification. PACCAR will repair parts found by PACCAR to be defective without charge for parts or labor (including diagnosis which results in determination that there has been a failure of a warranted part).

Warranty Limitations

Sole and exclusive remedy against PACCAR and the Selling Dealer arising from the purchase and use of this vehicle is limited to the repair or replacement of "warrantable failures", for replacement parts that are similar in material and function to OEM specifications and subject to PACCAR's time, mileage, and hour limitations of the greenhouse gas warranty. The maximum time, mileage and hour limitations of the warranty begin with the Date of Delivery to the first purchaser or first lessee. The accrued time, mileage, or hours is calculated when the vehicle is brought in for correction of warrantable failures. PACCAR is not responsible for failures or damage resulting from what PACCAR determines to be abuse, neglect or uncontrollable acts of nature, including, but not limited to: damage due to accident;

operation without adequate coolants or lubricants; overfueling; overspeeding; lack of maintenance of cooling, lubricating or intake systems; improper storage, starting, warm-up, run-in or shutdown practices; unauthorized modifications to the vehicle and its components. PACCAR is also not responsible for failures caused by incorrect oil, fuel or diesel exhaust fluid or by water, dirt or other contaminants in the fuel, oil or diesel exhaust fluid. Failure of replacement parts used in repairs due to the above non-warrantable conditions is not warrantable. This warranty is void if the vehicle is altered with parts that do not meet the material and functional specifications as manufactured from the factory. Any alterations to vehicle or engine computer settings will void GHG warranty and potentially cause the vehicle to become non-compliant with EPA Clean Air Act GHG regulations. Any alterations to GHG specific settings prior to the GHG related expiration mileage for each system will void GHG warranty and potentially cause the vehicle to become non-compliant with EPA Clean Air Act GHG regulations. This warranty is void if certain GHG components are not properly maintained and thus cannot perform to their designed capability. PACCAR is not responsible for

failures resulting from improper repair or the use of parts which are not genuine approved parts. PACCAR is not responsible for the material and labor costs of emission control parts and assemblies replaced during Scheduled Maintenance of the engine as specified in PACCAR Operator's Manuals. THIS WARRANTY, TOGETHER WITH THE EXPRESS COMMERCIAL WARRANTIES ARE THE SOLE WARRANTIES MADE BY PACCAR IN REGARD TO THIS VEHICLE. THIS LIMITED GHG WARRANTY IS THE SOLE WARRANTY MADE BY PACCAR AND THE SELLING DEALER. EXCEPT FOR THE ABOVE LIMITED WARRANTY, PACCAR AND THE SELLING DEALER MAKE NO OTHER WARRANTIES, EXPRESS OR IMPLIED. PACCAR AND THE SELLING DEALER EXPRESSLY DISCLAIM ANY WARRANTY OF MERCHANTABILITY OR WARRANTY OF FITNESS FOR A PARTICULAR PURPOSE. PACCAR AND THE SELLING DEALER SHALL NOT BE LIABLE FOR INCIDENTAL OR CONSEQUENTIAL DAMAGES INCLUDING, BUT NOT LIMITED TO: LOSS OF INCOME OR LOST PROFITS; ENGINE OR VEHICLE DOWNTIME; THIRD PARTY DAMAGE, INCLUDING DAMAGE OR LOSS TO

OTHER ENGINES, VEHICLES OR PROPERTY, ATTACHMENTS, TRAILERS AND CARGO; LOSS OR DAMAGE TO PERSONAL CONTENTS; COMMUNICATION EXPENSES; LODGING AND/OR MEAL EXPENSES; FINES; APPLICABLE TAXES OR BUSINESS COSTS OR LOSSES; ATTORNEYS' FEES; AND ANY LIABILITY YOU MAY HAVE IN RESPECT TO ANY OTHER PERSON OR ENTITY.

Telematics Control Unit FCC Information

General Information

Model	IC
TCU2 NA IP30	2AUXS-TCU2NAIP30A
TCU2 NA IP67	2AUXS-TCU2NAIP67A



NOTE

This device complies with Part 15 of the FCC Rules.

Operation is subject to the following two conditions:

1. This device may not cause harmful interference, and
2. This device must accept any interference received, including interference that may cause undesired operation.



NOTE

Changes or modifications not expressly approved by the party responsible for compliance could void the user's authority to operate the equipment.



NOTE

This equipment has been tested and found to comply with the limits for a Class B digital device, pursuant to Part 15 of the FCC Rules. These limits are

designed to provide reasonable protection against harmful interference in a residential installation. This equipment generates, uses and can radiate radio frequency energy and, if not installed and used in accordance with the instructions, may cause harmful interference to radio communications. However, there is no guarantee that interference will not occur in a particular installation. If this equipment does cause harmful interference to radio or television reception, which can be determined by turning the equipment off and on, the user is encouraged to try to correct the interference by one or more of the following measures:

- Reorient or relocate the receiving antenna
- Increase the separation between the equipment and receiver
- Connect the equipment into an outlet on a circuit different from that to which the receiver is connected
- Consult the dealer or an experienced radio/TV technician for help

Radiofrequency radiation exposure Information:

This equipment complies with FCC radiation exposure limits set forth for an uncontrolled environment. This equipment should be installed and operated with minimum distance of 8 in. (20 cm) between the radiator and your body. This transmitter must not be co-located or operating in conjunction with any other antenna or transmitter.

Used Frequency Bands (+antenna)

LTE

Band	MHz
7	2600
12 (incl. 17)	700
25 (incl. 2)	1900
26 (incl. 5)	850
66 (incl. 4)	1700
71	600

802.11ac	5180 - 5240 MHz
	5260 - 5320 Mhz
	5500 - 5700 Mhz
	5745 - 5825 MHz

empt RSS(s). Operation is subject to the following two conditions:

- This device may not cause interference
- This device must accept any interference, including interference that may cause undesired operation of the device

Canada-specific Information

Bluetooth and WiFi Frequencies

Bluetooth	2402 - 2480 MHz
Bluetooth, low energy	2402 - 2480 MHz
802.11b	2412 - 2742 MHz
802.11g	2412 - 2742 MHz
802.11n	2412 - 2742 MHz
	5180 - 5240 MHz
	5260 - 5320 MHz
	5500 - 5700 MHz
	5745 - 5825 MHz

Model	IC
TCU2 NA IP30	25847-TCU2NAIP30
TCU2 NA IP67	25847-TCU2NAIP67

Contains IC ID: 4441A-UMCSTD31BPN

 **NOTE**
 This device contains license-exempt transmitter(s)/receiver(s) that comply with Innovation, Science and Economic Development Canada's licence-ex-

RF Exposure Information:

This equipment complies with Canada radiation exposure limits set forth for an uncontrolled environment. Install and operate this equipment with minimum distance of 8 inches (20 cm) between the radiator and your body.

Mexico-Specific Information

The operation of this equipment is subject to the following two conditions:

- This equipment or device may not cause harmful interference and
- This equipment or device must accept any interference, including interference that may cause undesired operation

Index

A

- Activating the High Beam Assist (HBA) [181](#)
- Active Cruise Control Set Following Distance [171](#)
- Active Warnings [63](#)
- adaptive cruise control [161](#)
- Adaptive Cruise Control [170](#)
- Adaptive Cruise Control Notification, *See* ADAS Notification
- ADAS Camera Fault [84](#)
- ADAS Notification [66](#)
- Additives to Cooling System [286](#)
- Adjust Digital Camera Display Settings [133](#)
- Adjust Display Brightness [134](#)
- Adjust Glass Mirrors [135](#)
- Adjust Seat [19](#)
- Adjust Side Mirrors [121](#)
- Advanced ABS with Stability Control [196](#)
- Advanced Driver Assistance Systems (ADAS), *See* Driver Assistance
- Air Conditioner [139](#)
- Air Conditioner Sleeper [144](#)
- Air ConditionerDefrost Windshield [144](#)
- Air Disc Brakes [278](#)
- Air Dryer Maintenance [267](#)
- Air Filter Restriction Indicator [310](#)
- Air Gauges and Air Leaks [264](#)
- Air Intake [18](#)
- Air Intake System [307](#)
- Air System**
 - Air Compressor [266](#)
 - Air Dryer Oil-coalescing Cartridge [268](#)
- Air Tank Maintenance [269](#)
- Air Tanks [268](#)
- Air-Controlled Sliding Fifth Wheel [212](#)
- Air-Operated Kingpin Release, *See* How to Release the Kingpin from the Cab

- Air-Trac Fastener Torque ValueRear Suspension Fasteners [340](#)
- Alarm ClockSet alarm [147](#)
- Alarm ClockSet time [147](#)
- Alerts, what to do in the event of [138](#)
- Allison Transmission Lubrication [332](#)
- Altering the Electrical System [295](#)
- Alternator [301](#)
- Anti-Lock Brake System (ABS) [84](#)
- Anti-Theft [74](#)
- Antilock Brake System [84](#)
- At first 15,000 mi / 24,000 km or at first PM [229](#)
- Auto Slack Adjuster [279](#)
- Auto-neutral [191](#)
- Automated Emergency Braking, *See* Collision Mitigation
- Automatic Slack Adjuster Stroke Specification [280](#)
- Automatic time [70](#)
- Automatic Traction Control [198](#)
- Axle Temperature Gauge [93](#)
- Axle, Traction Control [85](#), [194](#)
 - See also* ATC
- AxleAuxiliary [206](#)
- AxleDiff Lock [204](#)
- AxleDifferential Lock [204](#)
- AxleDual Range [204](#)
- AxlePusher Tag [206](#)
- AxleTwo Speed [204](#)

B

- Back Button [62](#)
- Basic View [67](#)
- Batteries [296](#)
- Batteries, Low-Voltage Disconnect (LVD) [111](#)
- Battery Voltage [65](#)

Battery, Jump Start [45](#)

Belt

Lap/Shoulder [24](#)
Safety [22](#)

Bendix Fusion Camera [166](#)

Bendix Fusion Radar [167](#)

Bendix SafetyDirect Processor [167](#)

Bendix® AD-HF Series Air Dryer [267](#)

Border Color [127](#), [133](#)

Brake System [277](#)

Brake, Parking Manual release [49](#)

Brakes, ABS Off-Road [111](#)

Brakes, Antilock Brake System [84](#)

Brakes, Low Air [86](#)

Brightness [134](#)

Bulb Check [77](#)

Bunk Ladder [29](#)

Button Numbering, Used in Instructions, Drawing Showing [125](#)

C

Cab

How to Lock and Unlock the Doors [14](#)

Cab Access [13](#)

Cab Air Filter [285](#)

Cab HVAC Fresh Air Filter Replacement [285](#)

Cab Maintenance [280](#)

Cab Structure, Doors and Hoods [285](#)

Camera Lens Heater [136](#)

Camera Mode [133](#)

Camera Obstruction Conditions [175](#)

Camera Settings [133](#)

CAN bus [296](#)

Care of Display Screens on the Dashboard [285](#)

Caring For the DM System [137](#)

Check Engine Oil Level [303](#)

Cleaning LCD Display Screens [285](#)

Clock [65](#), [70](#)

Clutch Abuse Protection [192](#)

Cold Weather Operation [136](#)

Collision Mitigation [172](#)

Column Mounted Transmission Control [190](#), [191](#)

Coolant fill [289](#)

Coolant level [289](#)

Cooling system maintenance [286](#)

Cooling System Overheating [42](#)

Cranking Battery Specification [299](#)

cruise control [161](#)

Cruise Control [168](#)

Cruise Control Cancel [169](#)

Cruise Control Change Set Speed [169](#)

Cruise Control Resume Set Speed [169](#)

Cruise Control Set Speed [169](#)

Cruise Control Standard [167](#)

D

Daily Checks [35](#)

Dash Switch Tailer Hand Brake [194](#)

Dash Switches [100](#)

Dashboard Display Screen [285](#)

Day and Night Vision [133](#)

Deep Snow and Mud Switch [198](#)

Diesel Exhaust Fluid (DEF) Diesel Engines Only [68](#)

Differential, Inter-Axle Lock [86](#)

Digital Camera Display Settings [133](#)

Digital Display [74](#)

Digital Gauges [68](#)

Dimming Displays [134](#)

Display [74](#)

Display Border Color [133](#)

Display Brightness [134](#)

Display Launch [62](#)

DM Maintenance [137](#)

DNR Indicator [64](#)

Door Mounted Mirror Controls [121](#)

DPA, See Driver Performance Assistant

DR, See Driver Rewards

Drag Link Castle Nut Torque [336](#)

Drive Axle - Dana [274](#)
Drive Axle - Meritor [275](#)
Drive Axle SISU [277](#)
Drive Axle Temperature Gauge [93](#)

Driver Assistance

Object Detected Alert [172](#)
Driver Assistance Maintenance [293](#)
Driving Tips and Techniques [214](#)
Drum Brake Inspection [279](#)
Dual Air System Function Test [269](#)
Dual Range (Two-Speed) Rear Axle [204](#)
Dump Truck, Body Up [87](#)
Dump Truck, Gate [87](#)

E

Eaton/Dana Axle Lubrication [274](#)
ECU - Bendix SDP5 [294](#)
Effectiveness and Limitations [199](#)
Electrical System [294](#)
ELST, *See* Exterior Lights Self-Test
Emissions [184](#)
Emissions Engine Derate [90](#)
Emissions, High Exhaust System Temperature [88](#)
Enabling DM [127](#)
End Line [129](#)
Engine Aftertreatment System [184](#)
Engine Air filter [308](#)
Engine block heater [156](#)
Engine Brake [95, 99](#)
Engine Brake Allison Automatic Transmission [99](#)
Engine Brake Column Mounted Transmission Control [162](#)
Engine Brake indicator [161](#)
Engine Brake Manual Transmission [99](#)
Engine Brake PACCAR Transmission [162](#)
Engine Cooling Recommendations and Specifications [286](#)
Engine Fan [306](#)
Engine Fan Override [111](#)
Engine Hours [65](#)
Engine is overheating [42](#)

Engine Maintenance [302](#)
Engine Mounting [310](#)
Engine Start Module [45](#)
Engine Wait-To-Start Lamp [90](#)
Engine Warm Up [158](#)
Engine, Check Engine [89](#)
Engine, Low Coolant Level [89](#)
Engine, Overspeed [89](#)
Engine, Overspeed Air Shutdown [89](#)
Enhanced View [67](#)
ESM [45](#)
Every 120,000 mi / 192,000 km / Annually [254](#)
Every 15,000 mi / 24,000 km / Monthly [236](#)
Every 240,000 mi / 384,000 km [260](#)
Every 30,000 mi / 48,000 km [242](#)
Every 300,000 mi / 480,000 km / 6,750 Hours / 3 Years [260](#)
Every 500,000 mi / 800,000 km / 5 years [261](#)
Every 60,000 mi / 96,000 km / 6 Months [245](#)
Every 750,000 mi / 1,200,000 km / 24,000 Hours / 8 years [262](#)
Exhaust [184](#)
Exhaust System [310](#)
Exterior Lamp Self Test Switch [116](#)
Exterior Lights Self-Test [115](#)

F

Fast Idle Control [90](#)
Fault Alerts [138](#)
Favorites View [70](#)
Fifth Wheel [210, 212](#)
Fifth Wheel Bi-Annual Maintenance [312](#)
Fifth Wheel Monthly Maintenance [312](#)
Fifth Wheel Slide, *See* How to Slide the Fifth Wheel
Fifth Wheel Slide Switch [113](#)
Final Chassis Bill of Material [13](#)
Final Stopping Procedures [219](#)
Flash-to-Thank [96](#)
Flashing Headlamps, Aftertreatment Warning [184](#)
Flex Air Fastener Torque ValueRear Suspension Fasteners [342](#)
Frame [311](#)

Frame Fastener Torque Requirements [336](#)
Front axle and Suspension [269](#)
Front Suspension U-Bolts, Class 10.9 [339](#)
Fuel Level [69](#)
Fuel System [312](#)
Fuel Tank [313](#)
Fuse box label [295](#)
FuseInspect and replace [44](#)
FuseLocation [45](#)

G

General Safety Instructions [8](#)
Glass Mirror Adjustment [135](#)
Green Border [133](#)
Green Screen Border [127](#)
Greenhouse Gas Certified Configuration [351](#)
Greenhouse Gas Certified Tires [332](#)

H

Hand Brake Trailer [194](#)
Hands Off Detection [182](#)
HDB, See Highway Departure Braking
Headlight Flashing, See Lighting Controls
Heater and Air Conditioner Maintenance [313](#)
Heating and Air Conditioning [139](#)
High Beam Assist (HBA) [90](#), [180](#)

High Beams

How to turn on [97](#)

Highway Departure Braking [177](#)
Hill Hold [91](#)
Horn [95](#)
Horn honking, Aftertreatment Warning [184](#)
How To Activate Trailer Tracking [135](#)
How to Add Coolant to the Cooling System [290](#)
How To Adjust Display Brightness [134](#)
How to Adjust Mirrors [121](#)

How to Check the Compressed Air System for Leaks [265](#)
How to inspect brake pads on disc brakes [278](#)
How to Manually Control the Cab Air Conditioner [142](#)
How to Recover a VehicleTowing [47](#)
How to refill the washer fluid reservoir [335](#)
How to Replace Air Conditioner Filter [315](#)
How to Replace Headlamp Bulb [315](#)
How to Use Glass Mirror Adjustment Switches [135](#)
How to Use the ELST Switch [116](#)
How to Wash the Exterior of the Vehicle [283](#)
HVAC [139](#)
HVAC Air Filter [285](#)
Hydraulic Clutch [285](#)

I

Ice [55](#)
Illustrations [8](#)
In Cab Battery Access [298](#)
Indicators [78](#)
Initial Set Up [127](#)
Inside/Outside Engine Air Intake [112](#), [158](#)
Inspect Disc Brake Caliper for Running Clearance [279](#)
Inspecting Noise and Emission Components [321](#)
Install Engine Belt [305](#)
Installing Batteries [299](#)
Instruction Numbers, Drawing Showing [125](#)
Instrument Cluster [60](#)

K

Key Fob [301](#)
Keyless Entry [301](#)
Komfort Latch [26](#)

L

Lamps, Headlamps Flashing, Aftertreatment Warning [184](#)

Lane Departure [161](#), [175](#)
Lane Departure Warning (LDW) [91](#)
Lane Departure Warning (LDW) Disable [114](#)
Lane Departure Warning Fault [91](#)
Lane Departure Warning Mute, *See* Lane Departure Warning Disable
Lane Keeping Assist (LKA) [178](#)
Lane Keeping Assist (LKA) Enabled/ Engaged [92](#)
Lane Keeping Assist Disable [91](#)
Lane Keeping Assist Fault [91](#)
Lane Keeping Assist Mute, *See* Lane Departure Warning Disable

Language

English [70](#)
French [70](#)
Spanish [70](#)

LDW [175](#)
LDWS [161](#)
Lens Heater [136](#)
Light Bulb Specifications [343](#)
Light Self Test, *See* Exterior Lights Self-Test
Lighting Controls [184](#)
Lights, High Beam [91](#)
Locking the Fifth Wheel, *See* How to Lock the Kingpin
Low Air Alarm [41](#)
Low Air Leaf Fastener Torque ValueRear Suspension Fasteners [341](#)
Low Beam Flash, *See* Flash-to-Pass

Low Beams

Flash-to-Pass [97](#)
Low Oil Pressure Lamp [41](#)
Lubricants [318](#)
Lubrication Specification Chart [337](#)
LVD, *See* Low Voltage Disconnect

M

Maintaining DM [137](#)
Maintaining Headlight Performance [317](#)
Maintenance Manuals [13](#)
Maintenance Schedule [227](#)
Malfunction Indicator Lamp (MIL) [88](#)

Manifold Pressure Gauge [94](#)
Manual Camera Panning [135](#)
Manual Kingpin ReleaseFifth Wheel Operation [212](#)
Manually lock a differential [53](#)
Marker lights, *See* Lighting Controls
Marker Lights Flash, *See* Flash-to-Thank

MAX Mode

Operation [162](#)

Menu [70](#)
Meritor Axle Lubrication [275](#)
Metric Units [70](#)
ML, *See* Malfunction Indicator Light (MIL)
Minimized View [65](#)
Mirror Controls [121](#)
Mirror Passenger Side 'down' Mirror [151](#)
Mirror switch [121](#)
Monitor Brightness [134](#)
Monitors Show 'blue/purple effect' [138](#)
Mud [55](#)
Multiple Trailers [135](#)

N

Neutral Coast Mode [192](#)
New Vehicle Maintenance Schedule [225](#)
New Vehicle Maintenance Schedule: First 2,000 mi / 3,218 km [226](#)
New Vehicle Maintenance Schedule: First 50-100 mi / 80-160 km [225](#)
New Vehicle Maintenance Schedule: First 500 mi / 800 km [225](#)
New Vehicle Maintenance Schedule: First Day [225](#)
New Vehicle Maintenance Schedule:First 3,000-5,000 mi / 4800-8000 km [226](#)
Night Vision [133](#)
Noise and Emission Control [320](#)
Noise Control System - Maintenance Log [322](#)

Notifications

What are Notifications? [77](#)
Numbering of Buttons, Used in Instructions, Drawing Showing [125](#)

O

Odometer [65](#)
Off-Road ABS Function Switch (Optional) [199](#)
Oil Level [320](#)
Outside Air Temperature [63](#)
Overflow tank [289](#)

P

PACCAR AMT [191](#)
PACCAR AMT Shifting gears [191](#)
PACCAR FX-20 Front Axle Lubrication [271](#)
PACCAR Shifter [95](#)
Panning Angle [135](#)
Panning Angle Timeout [135](#)
Park Brake [86](#)
Parking lights, *See* Lighting Controls
PCC [173](#)
Pipe and Hose Clamp Torque Values [305](#), [335](#)
power distribution box [295](#)
Power Steering Fluid [327](#)
Power Take Off [164](#)
Pre-Trip Inspection [31](#)
Predictive Cruise Control [173](#)
Predictive Cruise Control Behavior [174](#)
Predictive Cruise Control Controls [175](#)
Predictive Cruise Control Interrupt [174](#)
Predictive Cruise Control Set Undershoot [175](#)
Predictive Cruise Control Software Information [175](#)
Predictive Cruise Control Troubleshooting [175](#)
Predictive Cruise Overshoot [71](#)
Prepare the Axles for Towing [52](#)
Preparing the Axles for Towing [52](#)
Program Key Fobs [302](#)
PTO [164](#)
PTO indicator [161](#)

R

Radiator Hoses [290](#)
Rear Axle Alignment [274](#)
Rear Axle and Suspension [272](#)
Rear Axle Lubrication [274](#)
Rear Suspension U-Bolts, Class 10.9 [339](#)
Recovery Hitch [50](#)
Recovery hitch capacities [54](#)
Recovery hitch How to use tow pin [51](#)
Recovery hitch Best practices [54](#)
Recovery hitch Prepare axles [52](#)
Red Border [133](#)
Red Screen Border [127](#)
Refrigerator [92](#)
Release Kingpin Fifth Wheel Operation [212](#)
Releasing the Kingpin, *See* How to Release the Kingpin from the Cab
Remote Keyless Entry [301](#)
Remove Optional Solenoid on Air Filter Housing [308](#)
Removing Batteries [299](#)
Repairs [12](#)
Replace Battery Box Cover [300](#)
Replace HVAC Air Filter [285](#)
Replace the Recirculation Air Filter [315](#)
Returning to Service after Recovering [55](#)
Roadside Assistance [41](#)
Roll Stability [197](#)
Roll Stability Example [197](#)

S

Safety Messages and Notes [7](#)
Safety Restraint System - Inspection [324](#)
Sand [55](#)
Screen Border Color [127](#)
Scroll Wheel [61](#)

Seat

Lap/Shoulder Belt [24](#)
Safety Restraint Belts [22](#)

Index

Seat Belt, Fasten [92](#)
Set Shut Down Timer [183](#)
Set Trailer End line [129](#)
Setting Up DM-M [127](#)
Settings [70](#)
Shortcuts [74](#)
Shut Down Timer [71](#)
Sleeper HVAC Air Filter [315](#)
Sliding Fifth Wheels [312](#)
Sliding the Fifth Wheel, *See* How to Slide the Fifth Wheel
Slow Battery Charging [300](#)
Snow [55](#)
Specific Cruise Indicator [86](#)
Speed Sign Recognition [178](#)
Speedometer [65](#)
Stability Control [85](#)
Standard Units [70](#)
Steering Shaft Bolt Torque Specifications [328](#)
Steering System [326](#)
Steering Wheel Controls [94](#)
Steering Wheel Pod Use [61](#)
Stopping Procedures [219](#)
Sub-trip Odometer [64](#)
Suppressing Popups [78](#)
Surge tank [289](#)
Suspension U-Bolts [339](#)
System Warnings [138](#)
Systems Check [37](#)

T

Tachometer [65, 216](#)
Telematics Control Unit FCC Information [357](#)
Testing Exterior Lights, *See* Exterior Lights Self-Test
Tether Belts [25](#)
Tilt Telescope [95](#)
Time [70](#)
Tire Inflation [92, 329](#)
Tire Pressure Monitoring System [37](#)
Tires [329](#)

Topping Up the Engine Oil [304](#)
Torque Assisted Steering [179](#)
Torque Assisted Steering Effort Adjustment [120](#)
Torque Assisted Steering Fault [92](#)
Tow Pin [50](#)
Towing Doubles Or Triples May Reduce The Effectiveness Of Stability Systems [201](#)
Towing the Vehicle [56](#)
TPMS [37](#)
Traction Control [118](#)
Trailer End Line [129](#)
Trailer Hand Brake [111, 194](#)
Trailer Hand Brake Dash Switch [194](#)
Trailer Tracking [135](#)
Transmission Gear Display [65](#)

Transmission Modes

DNR Indicator [64](#)
Transmission, Automated [189](#)
Transmission, Auxiliary [93](#)
Transmission, Check [93](#)
Transmission, Oil Temperature High [93](#)
Transmission Maintenance [332](#)
Trip Odometer [64](#)
Trip Summary [70](#)
Truck Info, *See* Truck Information
Truck Information [75](#)
Turbocharger [307](#)
Turn ON DM [127](#)
Turn Signal [95, 98](#)
Turn Signal, Left [93](#)
Turn Signal, Right [93](#)

U

Under Cab Battery Access [298](#)
Under hood air filter housing [18](#)
Under Hood Air Intake Symbol [112, 158](#)
Under Hood Intake [112, 158](#)
Unlock Fifth Wheel, *See* How to Release the Kingpin from the Cab
Unlocking the Fifth Wheel/Fifth Wheel Operation [212](#)
Using this Manual [7](#)

V

- Variable Road Speed Limiter [169](#)
- Variable Speed LimiterHow to Set the Variable Speed Limiter [170](#)
- Vehicle Emissions Limited Express Warranty [354](#)
- Vehicle ID Labels [347](#)
- Vehicle is stuck [55](#)
- Vehicle Loading [33](#)
- View Indicator [64](#)
- Visual inspection while approaching the vehicle [35](#)

W

- Warm Up, Engine [158](#)

Warning Lights

- Diesel Particulate Filter (DPF) [87](#)
 - Malfunction Indicator Light (MIL) [92](#)
 - Stop Engine [42, 89](#)
- Warnings [138](#)
 - Weekly Checks [37](#)
 - What to do before starting the vehicle [31](#)
 - Wheel Cap Nut Torque Specifications [343](#)
 - Wheels [332](#)
 - Windshield Wiper Interlock [71](#)
 - Windshield Washer [95](#)
 - Windshield Wiper [96](#)
 - Windshield Wiper/Washer [335](#)

Y

- Yaw Control [197](#)
- Yaw Control Example [198](#)
- Yaw Stability [197](#)

Your Servicing Dealer Is:



**Need Help? Give Us A Call - 24
Hours a Day
1-800-KW-ASSIST
1-800-592-7747**

**KENWORTH TRUCK COMPANY
P.O. Box 1000
Kirkland, Washington 98083-1000
(425) 828-5000**

**CANADIAN KENWORTH COMPANY
6711 Mississauga Road N.
Mississauga, Ontario L5N 4J8
(905) 858-7000**

© 2024 Kenworth Truck Company

**Do not remove the manual from vehicle.
Before operating vehicle study the manual carefully.
Read and understand all Warnings, Cautions, and Notes.**



Y53-1200-1L1